

THU2

S P A I N

ENGANCHES | BARRAS DE TECHO | PORTABICICLETAS | COFRES | PORTAEQUIPAJES | ACCESORIOS



2021

www.thu2.es

GENERAL

PEDIDOS Y ASISTENCIA PARA MONTAJE	1
LEGALIZACIÓN ENGANCHES ITV	6
TRANSPORTE / CONDICIONES GENERALES	220
LEYENDA	interior contraportada

BRINK

ENGANCHES	9
ENGANCHES PARA VEHÍCULOS	
HÍBRIDOS Y ELÉCTRICOS	13
ENGANCHE FIJOS	14
ENGANCHE DESMONTABLES	15
ENGANCHE RETRÁCTILES	16
KITS ELÉCTRICOS	17
LISTADO ENGANCHES POR MARCA DE VEHÍCULO	20
BARRAS	142
MÓDULOS PORTAEQUIPAJES	152
CONSEJOS USO BARRAS	155

PORTABICICLETAS DE BOLA DE REMOLQUE	159
PORTABICICLETAS DE TECHO	174
PORTABICICLETAS DE PORTÓN TRASERO	178
COFRES	185
BACAS Y SISTEMAS PORTACARGAS	197
PORTAESQUÍ	198
CADENAS DE NIEVE	201
DEPORTES NAÚTICOS	202
ESQUEMA 7 - 13 POLOS	204
ACCESORIOS ELÉCTRICOS ENGANCHES	205
ACCESORIOS ENGANCHES	207
ACCESORIOS REMOLQUES	208
ACCESORIOS VARIOS	213
EJES DE REMOLQUE	214
ACCESORIOS THULE PORTABICICLETAS	216
ACCESORIOS THULE COFRES Y VARIOS	217
ACCESORIOS THULE PROFESIONAL	218
ACCESORIOS CRUZ PROFESIONAL	219





Servicio de pedidos

Teléfono	976 493 113
Móvil/WhastApp	654 291 288
Fax	976 423 532
Correo electrónico	info@thu2.es
Web:	www.thu2.es

Nuestro equipo de ventas está a su disposición de lunes a viernes, de **9 a 13,30** y de **15,30 a 19** horas. Horario de recogida hasta las 18 horas.

Asistencia técnica para montaje

¿Tiene alguna pregunta relacionada con el montaje de un enganche o kit eléctrico de Thule?

¿Necesita ayuda?

Póngase en contacto con nuestro equipo de atención al cliente de lunes a viernes, de **9 a 13,30** y de **15,30 a 19** horas.

Teléfono	976 493 113
Móvil / WhastApp	654 291 288
Fax	976 423 532

Enganches de Remolque



Brink MX

Bola Retráctil

Para las personas que usan su enganche de remolque con regularidad, que consideran que el diseño de su automóvil es importante y que desean la máxima capacidad de uso.



Brink BMU

Bola desmontable Vertical Automático

El sistema Brink BMU ofrece una solución totalmente invisible después de retirar la bola. Esto es posible porque la carcasa en la que se bloquea la bola y el soporte del enchufe quedan escondidos detrás del paragolpes.



Brink BMA

Bola Desmontable Diagonal Automático

El sistema Brink BMA ofrece una gran facilidad de uso. Puede quedar parcialmente visible después de retirar la bola, por lo que es fácil ubicar la bola. También es posible guardar el soporte del enchufe detrás del paragolpes. El resultado final en la casi totalidad de los modelos es totalmente oculto.



Brink BMC

Bola Desmontable Horizontal Automático

El sistema Brink BMC es el que resulta más fácil de colocar la bola. La carcasa de bloqueo de la bola queda siempre visible. Algunos modelos pueden llevar el soporte de enchufe retráctil.



Brink Cisne

Bola Cuello de Cisne Fijo

Una bola Brink Cisne está siempre disponible y libre de mantenimiento. Ponga especial atención si el vehículo está equipado con sensores de proximidad traseros.



Brink Placa

Bola de Placa Fija

La bola Brink Placa es ideal para los usuarios de una furgoneta, pick-up o chasis-cabina. Está diseñada para el trabajo más pesado y, por lo tanto, se utiliza principalmente en el sector profesional. Puede arrastrar fácilmente remolques con un peso de más de 3 toneladas.



Thu2 Mixta

Bola de Placa Fija con pasador

La bola Thu2 Mixta adecuada para usuarios de vehículos comerciales e industriales para maximizar las opciones de transporte de remolque (no válida para usar con portabicicletas).

Kits Eléctricos



Kit Básico

7 y 13 polos

Adaptable únicamente a vehículos sin sistemas de red Can-Bus o Multiplexados, y sin check-control de luces.



Kit Universal con centralita

7 y 13 polos con o sin desconector de PDC

El kit Universal es adaptable a la práctica totalidad de los vehículos actuales y compatible con los sistemas check-control de luces, Can-Bus o Multiplexados. No necesita reprogración del ECU del vehículo. Incluye desconexión de la luz antiniebla del vehículo.



Kit Universal con centralita NFC

7 y 13 polos, programable con o sin desconector de PDC

Es adaptable a todos los vehículos actuales y compatible con todos los sistemas de iluminación por bombilla o por LED, incluso con LED de bajo consumo. Además lo puedes configurar con tu smartphone. Incluye desconexión de la luz antiniebla del vehículo.



Kit Específico

Conectores de origen

Para cada vehículo hay desarrollado un kit eléctrico específico. Puede conectarse directamente a la red Can-Bus y funciona de forma coordinada con otros elementos electrónicos del vehículo.

Accesorios de Transporte



Barras de techo

Aluminio o Acero

Unas barras de techo son la opción preferida de muchos usuarios. Elige el modelo adecuado a tu vehículo y complétalas con el accesorio perfecto para tu necesidad, ya sea para portabicicletas, portaesquí, cofres o deportes de agua.



Cofres

Amplía tu volumen de carga

La amplia gama de maleteros de techo se adapta a todas las necesidades: si llevas una vida activa, vas de vacaciones o sencillamente necesitas más espacio.



Portabicicletas

Sobre bola de remolques, en el techo o en el portón trasero

Tanto si vas sólo como con familiares y amigos, los soportes de bicicleta te ayuda a transportar las bicicletas de forma segura y sencilla. Consúltanos el modelo más adecuado para tu necesidad o visita www.thu2.es.



Portaesquí / Porta tablas de Snow

Para barras de techo

Ya sea para transportar tus esquís o tus tablas de snow, tenemos el accesorio adecuado para ti. Tenemos diferentes opciones en función de cuántos quieras transportar o de las barras de techo que tengas.



Deportes náuticos

Portakayak, Portacanoas, Tablas de Surf

Con la amplia gama de accesorios puedes llevar tu tabla, tu canoa o tu kayak donde tú quieras.



Bacas

Para los profesionales

Las bacas portaequipajes que ayudan a los profesionales en su trabajo diario. En acero o aluminio. Puedes completarlo con una amplia gama de accesorios que te facilitarán el trabajo.

Accesorios



Accesorios de enganches

Un tapabolas, la bolsa de tela para guardar tu bola desmontable, una llave de repuesto, una bola, todo lo que necesites para tener tu enganche como el primer día.



Accesorios eléctricos

Adaptadores de 13 a 7 o de 7 a 13 polos, bases de enchufe de PVC o de aluminio, manguera de cable, tester comprobadores, ...



Accesorios de remolque

Cabezales, pilotos, ruedas jockey, ruedas para remolque, guardabarros, toldos, rampas y muchos más.



Accesorios Varios

Placa V20 de PVC o de chapa, protectores de cabezal, cabrestantes, ganchos, pulpos, eslingas, antirrobo,...



Accesorios Thule / Cruz

Extensiones para 1 bici, rampas de carga para portabicicletas, soportes para transportar los esquís en el cofre, adaptadores, fundas de cofre, toldos, topes de retención, rulos y pasarelas para bacas, portaescaleras; completa tu producto con el accesorio adecuado.

www.thu2.es

THU2.ES

Con un nuevo diseño, atractivo, moderno y, sobre todo, muy funcional, presentamos el nuevo sitio web de Thu2.



Además de actualizar el buscador de enganches, con información ampliada de cada uno de nuestros modelos de enganches, hemos añadido un nuevo buscador de barras de techo para que realizar las consultas sea un trabajo sencillo, rápido y poder ofrecer a tus clientes la información que necesitan en el momento.

La agilidad en la tramitación de los informes de conformidad ha sido uno de los retos más importantes, reduciendo el tiempo en el que se envía, ahora es posible que lo recibas nada más realizar la solicitud.

Por otra parte, hemos ampliado la información sobre cada uno de los productos que ponemos a tu disposición, portabicicletas, bacas, portaesquí, portacanoas, con imágenes precisas e incluso vídeos

explicativos de su funcionamiento.

Queremos estar en permanente contacto con nuestros clientes y ofrecer nuevas posibilidades de negocio.

INFORME DE CONFORMIDAD

Accede a Informes de Conformidad -> Solicitar Informe de Conformidad, cumplimenta el formulario, valida la aceptación de condiciones y pulsa **SOLICITAR INFORME DE CONFORMIDAD**. Recibirás un mail de confirmación si el proceso es correcto y en pocos minutos tendrás tu Informe en el buzón de tu correo electrónico. Además recibirás un cupón descuento de **2,00€** (IVA incluido) para canjear en tu próxima compra on-line de un enganche de remolque Brink.

Recuerda que necesitas los datos que figuran en la ficha técnica del vehículo y la referencia del enganche. (Ver página 6).

PEDIDOS ON-LINE



Uno de los grandes retos ha sido la creación de la tienda on-line, desarrollada únicamente **para profesionales**, para nuestros clientes.

Realizar tu pedido ahora es mucho más fácil, puedes utilizar el buscador de enganches o barras de techo, pero también el buscador general, donde puedes encontrar el producto que deseas por el nombre o la referencia, añádelo a tu carro de compra y confírmalo. Así de fácil.

REGISTRO

Tu primer paso es crear una cuenta de usuario. Para ello debes Registrarte con un nombre de usuario y una contraseña propia, y cumplimentar los campos que se solicitan. Deberás esperar a que validemos tu solicitud de registro para realizar tu primer pedido. Una vez validada la cuenta, ya puedes disfrutar de todas las ventajas de formar parte de Thu2 Spain on-line a cualquier hora y desde cualquier lugar.

CUENTA

Llevar un control de los pedidos que realizas es fundamental, por eso, desde **SU CUENTA** tienes acceso a toda tu información, direcciones de envío, direcciones de mail, teléfonos de contacto y, sobre todo, a la gestión y control de tus pedidos. Saber el qué y cuándo has realizado tu pedido es importante.

¿Tienes más de un punto de venta y quieres acceder desde todos ellos? Es fácil, utiliza el mismo usuario y la misma contraseña, se puede trabajar desde varios puestos al mismo tiempo, así tendrás todo bajo control, simplemente registra cada una de las direcciones y selecciona la adecuada cuando hagas el pedido.

SIEMPRE INFORMADO

Ya sea un pedido o la solicitud de un informe, siempre recibirás un mail de confirmación si la gestión se ha realizado correctamente y cuál es la situación en la que se encuentra tu trámite.



CONECTIVIDAD

¿No estás en la oficina? Tranquilo, nuestra web se ha desarrollado para adaptarse a los dispositivos móviles. Ya sea desde tu Smartphone o desde un Tablet, siempre estás conectado con tu cuenta y podrás realizar los mismos trámites que desde tu ordenador de oficina.

PRODUCTO

No tendrás que preocuparte por los nuevos productos, toda la información es actualizada a diario, siempre verás lo último, ya sea sobre nuevos desarrollos de enganches, barras de techo, portabicicletas, cofres, portaesquí, accesorios; en fin, todo de todo. Y si un producto ya no se comercializa, también lo sabrás, simplemente no estará disponible en el buscador.

ACCESO DESDE CUALQUIER DISPOSITIVO

Una de nuestras principales herramientas es un teléfono móvil o smartphone, por eso la aplicación web de Thu2 se adapta de forma automática al dispositivo desde el que accedes. Ya sea un smartphone o un tablet siempre estarás conectado con nosotros. Y lo mejor es que no tienes que instalar ninguna aplicación, sólo entra desde tu navegador favorito, Google Chrome, Mozilla FireFox, Explorer, Safari,... y realiza tu pedido.

Menú Principal

Accede a cada sección de producto. Enganches, Barras de techo, Portabicicletas, Portaequipajes o Accesorios.

Buscador de Enganches

La forma más fácil y precisa de saber que opciones de enganche tiene cada modelo de vehículo. Y si conoces la referencia, puedes ir al producto de forma directa. Visualizar la foto del vehículo, descargar el manual, saber si lleva recorte el parachoques o como es el soporte de enchufe son datos que puedes ver.

Buscador de Barras de Techo

¿No sabes si las quieres Thule o Cruz? No te preocupes, una vez que ya has elegido el modelo de vehículo y el fabricante puedes cambiar de uno a otro con un sólo click, y seleccionar la que más te convenga.

Su Cuenta

Todos tus datos están aquí. Puedes consultarlos, modificarlos o añadir nuevos. También acceder al historial de tus pedidos o saber el estado en el que se encuentra tu pedido.

Informes de Conformidad

Nunca ha sido tan fácil y tan rápido. Cumplimenta los datos solicitados en el formulario. Recuerda tener a mano la ficha técnica del vehículo y la referencia del enganche.



RÁPIDO Y FÁCIL



Cómo solicitar el Informe de Conformidad desde www.thu2.es

Para conocer el emisor del Informe de Conformidad, o en su caso, la realización de un Proyecto Técnico, hemos dispuesto en nuestro sitio WEB, www.thu2.es, una herramienta que permite saber este dato de forma rápida y sencilla

Hay dos vías por la que tenemos acceso al formulario, bien por el Buscador de enganches o directamente desde el enlace de la página de inicio **Solicitar Informe de Conformidad**.

Opción 1. Usando el BUSCADOR de enganches

- 1. Seleccionamos:** Marca, Modelo, Carrocería y Año y hacemos *click* en **BUSCAR** bajo la imagen del tipo de bola hacemos *click* en el enlace **COMPROBAR Y SOLICITAR INFORME DE CONFORMIDAD**

Enganche adaptable a Citroën Berlingo III (K9) Furgon 2018-

Enganche con bola fija

Tipo de bola: CISNE (Incluido con sensor de marcha atrás)

Referencia: 660200

Recorte parabolajes: No

Tiempo montaje: 30-60

Inicio de fabricación: 08/2018

Fin de fabricación: STOCK

185,00 €

I.V.A no incluido

COMPROBAR Y SOLICITAR INFORME DE CONFORMIDAD

VER DETALLES

- 2. Introducir la matrícula** y una dirección de correo electrónico, hacemos *click* en **ENVIAR**

Matrícula	E-mail
<input type="text"/>	<input type="text"/>
ENVIAR	

- 3. Seleccionamos** el tipo de ficha técnica del vehículo haciendo *click* en la imagen que corresponda

Referencia: [5e4a837696d4e](#)

Seleccione su versión de ficha técnica:

THU2

REFORMAS EN EL VEHICULO

REFORMAS AUTORIZADAS

Ampliar

- 4. Rellenamos** todos los campos del formulario y hacemos *click* en **GUARDAR** y, a continuación, en **COMPROBAR DATOS**

Número de asientos: (S1)	<input type="text"/>
Contraseña de homologación (Contraseña) (K) ●	<input type="radio"/> B- <input type="checkbox"/> <input type="radio"/> C- <input type="checkbox"/> <input type="radio"/> e- <input type="text"/> Año/ <input type="text"/>
Vehículos completados ●	<input type="radio"/> No <input type="radio"/> Si
Clasificación del vehículo (CL) ●	<input type="checkbox"/> <input type="checkbox"/>
Categoría del vehículo: (J)	<input type="radio"/> MI <input type="radio"/> NI <input type="radio"/> MIG <input type="radio"/> N1G
Reformas autorizadas:	<input type="radio"/> No tiene Reformas autorizadas <input type="radio"/> Tiene reformas autorizadas y Thu2 le ha confirmado vía email que NO afectan a la emisión del informe de conformidad firmado por Thu2 <input type="radio"/> Tiene reformas autorizadas y afectan a la emisión del informe firmado por Thu2 Ejemplo: Cambio de clasificación, modificación de datos técnicos, bajada de MMA, Instalación de enganche (anterior al colocado en este acto) Instalación o desinstalación de Defensas, estanterías, espejos, soporte rueda repuesto, cabestrante, alerones, estribos, taloneras, peldaños fijos, peldaños asistidos, sustitución parachoque, equipos de frío / calor, portaequipajes anclados en lugares no previstos por el fabricante, soportes de (rotulos, cartel publicitario, alumbrado), paso de ruedas ensanchados, carretillas elevadoras...
Referencia del enganche	<input type="text" value="660200"/>
GUARDAR COMPROBAR DATOS	



5. Si todo es correcto veremos la siguiente información

VERIFICACIÓN DATOS FICHA TÉCNICA Referencia: 5e4a837696d4e

<input checked="" type="checkbox"/>	Comprobar MMR	MMR resultante es 2445	En principio es suficiente con el informe emitido por Thu2
<input checked="" type="checkbox"/>	MTMA = Tara + (nº asientos x 75 kg) + S	MMR resultante es 1500	En principio es suficiente con el informe emitido por Thu2
<input checked="" type="checkbox"/>	MTMA = MMR con freno	MMR resultante es 1500	En principio es suficiente con el informe emitido por Thu2
<input checked="" type="checkbox"/>	(MOM / 2) = MMR sin freno	MMR sin freno 660	En principio es suficiente con el informe emitido por Thu2
<input checked="" type="checkbox"/>	MMR sin freno	660	En principio es suficiente con el informe emitido por Thu2
<input checked="" type="checkbox"/>	Contraseña Homologación vehículo	e*2007/0607*30	En principio es suficiente con el informe emitido por Thu2
<input checked="" type="checkbox"/>	Vehículos completados	No	En principio es suficiente con el informe emitido por Thu2
<input checked="" type="checkbox"/>	Reformas autorizadas	No tiene Reformas autorizadas	En principio es suficiente con el informe emitido por Thu2

ESTA INFORMACIÓN NO TIENE CARÁCTER CONTRACTUAL, SOLAMENTE ES INFORMATIVA
En el caso de ser necesario informe o proyecto de laboratorio será necesario el de mayor coste.

 [CONTINUAR LA SOLICITUD DE INFORME DE CONFORMIDAD](#) [VOLVER AL BUSCADOR DE ENGANCHES](#)

6. A partir de aquí podemos:

- **CONTINUAR CON LA SOLICITUD DEL INFORME DE CONFORMIDAD.** Debemos de terminar de rellenar los campos vacíos del formulario, Marca, Tipo, Variante, Denominación Comercial, n.º de bastidor... y los datos de la empresa que solicita el informe. Validamos la Política de Privacidad, hacemos *click* en **GUARDAR**, y, a continuación, en **SOLICITAR INFORME**. En la siguiente pantalla tendremos que hacer *click* en **FINALIZAR**. **VOLVER AL BUSCADOR DE ENGANCHES**

- Anotar el número de referencia de la parte superior derecha para recuperar los datos introducidos más adelante, e introducir este número en la celda *Continuar el Informe con Referencia*, a esta pantalla se accede desde la página de inicio en el enlace [SOLICITAR INFORME DE CONFORMIDAD](#)

Ya sólo queda esperar unos minutos para recibir en su cuenta de correo el Informe.

7. Si hay algún dato no favorable, la información se mostrará con el texto en rojo y, entonces, deberá ponerse en contacto con nosotros por e-mail: info@thu2.es o por teléfono al 976 493 113.

VERIFICACIÓN DATOS FICHA TÉCNICA Referencia: 5e4a837696d4e

<input checked="" type="checkbox"/>	Comprobar MMR	MMR resultante es 2445	En principio es suficiente con el informe emitido por Thu2
<input checked="" type="checkbox"/>	MTMA = Tara + (nº asientos x 75 kg) + S	MMR resultante es 1500	En principio es suficiente con el informe emitido por Thu2
<input checked="" type="checkbox"/>	MTMA = MMR con freno	MMR resultante es 1500	En principio es suficiente con el informe emitido por Thu2
<input checked="" type="checkbox"/>	(MOM / 2) = MMR sin freno	MMR sin freno 660	En principio es suficiente con el informe emitido por Thu2
<input checked="" type="checkbox"/>	MMR sin freno	660	En principio es suficiente con el informe emitido por Thu2
<input checked="" type="checkbox"/>	Contraseña Homologación vehículo	e*2007/0607*30	En principio es suficiente con el informe emitido por Thu2
<input checked="" type="checkbox"/>	Vehículos completados	No	En principio es suficiente con el informe emitido por Thu2
<input checked="" type="checkbox"/>	Reformas autorizadas	Tiene Reformas autorizadas y afectan a la emisión del informe firmado por Thu2	Necesita informe laboratorio, coste 70€ + IVA

ESTA INFORMACIÓN NO TIENE CARÁCTER CONTRACTUAL, SOLAMENTE ES INFORMATIVA
En el caso de ser necesario informe o proyecto de laboratorio será necesario el de mayor coste.

THU2 no puede emitir el informe de conformidad, anote el número de referencia del informe (ver esquina superior derecha) y póngase en contacto con nosotros mediante email a Thu2 Spain o teléfono 976 493113 para ampliarle la información.

Opción 2. Desde el enlace [SOLICITAR INFORME DE CONFORMIDAD](#) de la página de inicio www.thu2.es, y cumplimentando todos los campos del formulario, incluida la referencia del enganche, o bien, recuperando los datos que habíamos introducido anteriormente, mediante el N° de referencia de informe, que previamente lo deberíamos de haber anotado.

Una vez cumplimentados todos los campos, validamos la Política de Privacidad, hacemos *click* en **GUARDAR**, y, a continuación, en **SOLICITAR INFORME**.

En la siguiente pantalla tendremos que hacer *click* en **FINALIZAR**. Recibiremos en nuestro mail la confirmación de la solicitud y posteriormente otro mail con el Informe de Conformidad.



¿Quién emite el informe de conformidad?

El 1 de octubre de 2019 entró en vigor el nuevo Manual de Reformas de Vehículos por el que se regula la legalización de los enganches de remolque. De forma habitual será Thu2 quien emita el Informe de Conformidad, pero hay supuestos en los que deberá ser un Servicio Técnico de Reformas (Laboratorio) quien emita el Informe de Conformidad o en su caso, el Proyecto Técnico.

Es necesario Informe de Conformidad de Laboratorio cuando:

1. La MMR calculada con los datos del enganche sea inferior a la MMR con freno del vehículo (O.1 o O.1.3).
2. La MMTA (F.1) es menor a MOM (G) (tara +75 kg) + ((nº asientos-1) x 75 kg)) + Valor S (carga vertical).
3. La MMTA (F.1) es menor a MMR con freno del vehículo (O.1 o O.1.3).
4. La MOM(G)/2 es menor a MMR sin freno (O.1.4).
5. Vehículos Completados con clasificación 32 (autocaravanas MMA \leq 3.500 Kg).
6. Tiene una reforma anotada en la ficha técnica.

Es necesario Proyecto Técnico en los siguientes casos:

1. Vehículos homologados con normativa nacional B****, C**** o CE anterior al año 1994 (e9*93/81*).
2. Vehículos Completados (con dos contraseñas de homologación (K y K.1) y clasificación diferente a 32.

¿Qué documentación es necesaria para legalizar un enganche de remolque Brink?

A. Para legalizar el enganche de remolque Brink debe entregar en ITV los siguientes documentos:

- Instrucciones de montaje (incluidas con el enganche)
- Certificado de montaje del taller instalador
- Informe de conformidad emitido por Thu2 o un Servicio Técnico de Reformas (Laboratorio), o Proyecto Técnico.

B. Para solicitar el Informe de Conformidad o, en su defecto, el Proyecto Técnico al laboratorio, es necesario que nos hagan llegar la siguiente documentación:

- Copia de la Ficha técnica del vehículo (de todas las caras de la Ficha Técnica para comprobar que no se han realizado reformas y que están todas las inspecciones periódicas anotadas).
- Copia del Permiso de circulación del vehículo.
- Certificado de montaje del instalador.
- Fotografías de la parte trasera del vehículo con el enganche instalado (es necesario que se vea la matrícula del vehículo).
- Fotografía del enganche en el que se vea la placa de homologación.
- Fotografía de la distancia del suelo al centro de la bola. (c).
- Fotografía de la distancia del paragolpes al centro de la bola. (a).
- Fotografía del enganche instalado en los puntos de anclaje del vehículo (sólo en proyecto técnico).

Las medidas que se deben cumplir son las siguientes:

- Cota a = distancia del centro de bola a la zona más saliente del paragolpes, mínimo 65 mm
- Cota b = distancia del centro de bola hasta el final de la rueda
- Cota c = distancia del centro de bola al suelo entre 35 y 42 cm con el vehículo cargado. En vehículos clasificados como Todo Terreno no hay restricción
- Cota R = distancia del centro de bola a la rueda de recambio o la parte más saliente de la carrocería en vertical debe ser mínimo de 205 mm

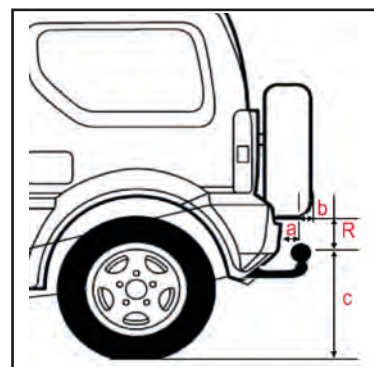

Consideraciones a tener en cuenta

- La fecha del certificado de montaje debe ser anterior o la misma que la del informe de conformidad.
- Existe obligación de legalizar el enganche en la ITV durante los 15 días siguientes a la fecha de su instalación. Thu2 no se hará responsable de posibles cambios de normativas, homologaciones... con posterioridad a la venta del enganche.
- Thu2 Spain no se responsabiliza del criterio aplicado en la ITV.
- Thu2 Spain no se responsabiliza de la verificación de los datos aportados por el cliente ni tampoco de los datos introducidos al solicitar el informe de conformidad. Por favor, compruebe antes de hacer el pedido del enganche, que su vehículo está capacitado para remolcar y verifique el informe de conformidad antes de ir a la ITV a legalizarlo.

THU2

S P A I N

Importador exclusivo para España y Portugal de Brink



BRiNK[®]

Your perfect fit

Your perfect fit

El desarrollo de los enganches de remolque Brink se basa en el principio "Your perfect fit". Esto se traduce en la calidad de los enganches y kits eléctricos y el apoyo en cuanto a las ventas y el montaje.

• Calidad

Mejor ajuste. Los enganches de remolque Brink son famosos por su ajuste óptimo. Gracias a la innovación continua, la aplicación del escaneado 3D de vehículos durante el desarrollo y las tecnologías de producción modernas, Brink fabrica enganches de remolque según las normas europeas vigentes, reforzadas por nuestra propia normativa. Como consecuencia, Brink siempre ofrece la mejor solución para prácticamente cualquier tipo de coche, incluso los vehículos híbridos y eléctricos más modernos. Por lo tanto, no es de extrañar que Brink sea proveedor de la mayoría de fabricantes de automóviles.

Seguridad. Los enganches de remolque Brink siempre cumplen con la carga vertical máxima y el peso máximo de remolque permitido del vehículo. Los enganches han sido probados de forma exhaustiva en nuestros centros de pruebas Brink acreditados y cumplen con las normas obligatorias y recomendadas (DIN-ISO, ECE R55, Tüv-GS y CARLOS, CityCrash...). Una solución segura gracias a la calidad y garantía de la reconocida marca mundial Brink.

• Soporte de instalación

Manuales de instalación. Los enganches de remolque y kits eléctricos Brink son suministrados con un manual de instalación claro y preciso que le facilitará el montaje del enganche de remolque.

Plantilla adhesiva de marcación inteligente Brink. Si hace falta recortar el paragolpes a la hora de instalar el enganche de remolque, puede utilizar la '*plantilla adhesiva de marcación inteligente*' suministrada. Pegando la plantilla en el paragolpes, le resultará más fácil realizar un recorte perfecto.

Con enganches de remolque Brink conseguirá clientes satisfechos y una gestión eficaz de su negocio.

Esperamos que disfrute con el montaje del próximo enganche de remolque Brink.





El desarrollo de un enganche Brink

Fase 1

Escaneo digital de la parte trasera del vehículo mediante brazo de medición digital en 3D.

Fase 2

Diseño del enganche centrado en:

- Puntos de anclaje al chasis del vehículo.
- Datos de carga (según lo indicado por el fabricante del automóvil).
- Altura requerida legalmente del centro de la bola al suelo.
- Distancia del centro de la bola al parachoques del vehículo.
- Utilizar la menor cantidad de material para hacerlo lo más ligero posible.
- Crear una solución de enganche que se integre perfectamente en el vehículo, evitando, si es posible, quitar el parachoques o el recorte del mismo; lo que ayuda a reducir el tiempo de montaje.

Fase 3

Utilizando el CAD FEM se realiza el cálculo sobre la carga, la tensión y la deformación que sufre el material.

Fase 4

Fabricación del prototipo que se somete a las siguientes pruebas:

- Prueba de fatiga aplicando el Test Carlos 3D, cumpliendo con las directrices europeas 94/20 y R55.
- Prueba de fluidos para detectar posibles grietas en el material tras el ensayo.
- Prueba estática, para determinar la elasticidad de la bola y del punto de anclaje de la cadena de seguridad del remolque.
- Prueba de resistencia de los tornillos de unión.
- Prueba de la cámara climática, el material se somete a temperaturas de entre -40° y $+80^{\circ}$.
- Prueba de salinidad donde se comprueba la resistencia a la formación de óxido.

La marca preferida de los fabricantes de automóviles

Brink es la opción preferida por la mayoría de los fabricantes de automóviles, con quienes mantiene una estrecha colaboración durante la fase de desarrollo del vehículo, contribuyendo a sus procesos de innovación, diseño y construcción para garantizar enganches de la más alta calidad, fáciles de usar y con la máxima seguridad.



Escaneo del vehículo.



Diseño CAD-CAM.



Cabinas de soldadura.



Test Carlos (R55), ensayo en 3D.

¿De qué elementos se compone un enganche BRINK?

Partes

Para el usuario final, un enganche de remolque no deja de ser la bola negra que se ve en la parte posterior del vehículo. Pero un enganche se compone de muchas partes y piezas.

Brazos laterales

Estas piezas conforman la unión entre el enganche y el chasis del vehículo. Es fundamental prestar especial atención en su fijación. Se diseñan con la máxima precisión para que su montaje sea fácil y rápido.

Cuerpo principal

Es la base principal sobre la que se unen la bola y las piezas de fijación al chasis

Placas de unión de la bola

Estas piezas están unidas mediante soldadura al cuerpo principal. La bola se fija mediante tornillos. Una o ambas placas disponen de un ojo que sirve para fijar el cable de seguridad de unión al remolque.

Soporte de enchufe

La toma eléctrica está instalada aquí. Dependiendo del vehículo y del tipo de bola se utiliza un sistema fijo, para enganches con bola fija, o un sistema plegable, para enganches con bola desmontable o retráctil.

Bola de enganche

Este es el sistema donde descansa el acoplamiento de remolque. Hay muchos tipos y tamaños de bolas. Se selecciona la bola para un diseño óptimo cumpliendo las reglamentaciones de altura al suelo y distancia al paragolpes

Caja de Alojamiento

Funciona como un seguro para el bloqueo de las bolas desmontables. Brink tiene diferentes sistemas para las bolas horizontales, diagonales o verticales.

Mecanismo de bloqueo

Permite que la bola desmontable sea bloqueada o desbloqueada. Incluye llave de seguridad antirrobo



Brink RMC



La solución para vehículos híbridos y eléctricos.

Disfruta de tu bicicleta allá donde vayas aunque tu vehículo no tenga capacidad de carga de remolque.

El mercado de automóviles híbridos, eléctricos y de tamaño pequeño que no tienen capacidad de remolque está tomando cada vez más importancia. En los vehículos híbridos y eléctricos hay un exceso de trabajo de la batería que reduce su duración y, por otro lado, la obligatoriedad de reducir las emisiones hacen que no se homologue la capacidad de remolque en muchos modelos de vehículos; sin embargo, la mayoría de ellos tienen capacidad de carga vertical, lo que hace posible una solución de transporte. Brink ha desarrollado el sistema RMC con la finalidad de cubrir las necesidades de los usuarios de estos vehículos, por lo que es posible instalar un enganche de remolque Brink para transportar un portabicicletas, por ejemplo: el Thule VeloCompact 925 (2 bicicletas). Ver página 124.

El sistema Brink RMC no es compatible para su uso con remolques o caravanas, ya que incorpora unos salientes en la propia bola que impiden su acoplamiento.

Para poder legalizar este tipo de enganche en el vehículo es necesario realizar un proyecto técnico a presentar junto con el resto de documentación en ITV. Consulte el coste del proyecto antes de elaborar un presupuesto a su cliente, así como los precios y disponibilidad del sistema de enganche con sistema Brink RMC.

Tipos de bola:



RMC**Ch**



RMC**u**



Brink Cisne

Calidad funcional.

¿Es un usuario habitual de un sistema de enganche y busca sacar el máximo partido a su inversión? Los sistemas de enganche fijos de Brink combinan facilidad de uso y duración en las condiciones más extremas. Una elección de calidad.



Brink Placa

Seguridad para los profesionales.

Para vehículos comerciales y todoterreno, Brink ofrece una gran variedad de bolas clásicas, diseñadas para su montaje en vehículos de pasajeros, comerciales y todoterreno, todas ellas con la certificación obligatoria de la UE. En los transportes donde no hay margen de error, las bolas clásicas Brink han sido la opción preferida por los usuarios durante muchos años.



Thu2 Mixta

Para el trabajo profesional.

Bola especial con pasador para vehículos comerciales y todo terrenos que tienen que arrastrar remolques con cabezal de anillo.



Todos los enganches de remolque de la gama Brink ofrecen las siguientes ventajas:

- » Bola de remolque de una sola pieza de acero de alta calidad sin soldaduras.
- » Montaje rápido; durante el diseño nos centramos en un ajuste perfecto.
- » Cumple con las normas obligatorias y recomendadas (DIN-ISO, ECE R55, Tüv-GS, CityCrash).
- » Carga vertical sobre bola y carga de presión máxima permitida por el vehículo.
- » Es la elección de la mayoría de fabricantes de vehículos.

Elige la opción adecuada en www.thu2.es

Brink BMC / BMA / BMU

Desmontable, práctico y seguro.

Los enganches desmontables Brink de la serie BM permanecen ocultos cuando no se utilizan. El enganche se puede colocar de forma segura y fácil, con una sola mano. Este sistema no perjudica al diseño del vehículo y permite que el enganche esté disponible de inmediato.



BMC

Desmontable horizontal*



BMA

Desmontable diagonal*



BMU

Desmontable vertical

* Existen vehículos que no permiten instalar enganches diagonales o verticales, en estos casos la solución perfecta es una bola horizontal BMC o BMAh.

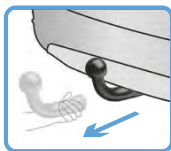

Brink MX

El enganche retráctil de Brink. Invisible y siempre disponible.

Ahora lo ves y al momento dejas de verlo. El sistema de enganche retráctil Brink MX se oculta detrás del parachoques del vehículo cuando no se utiliza.

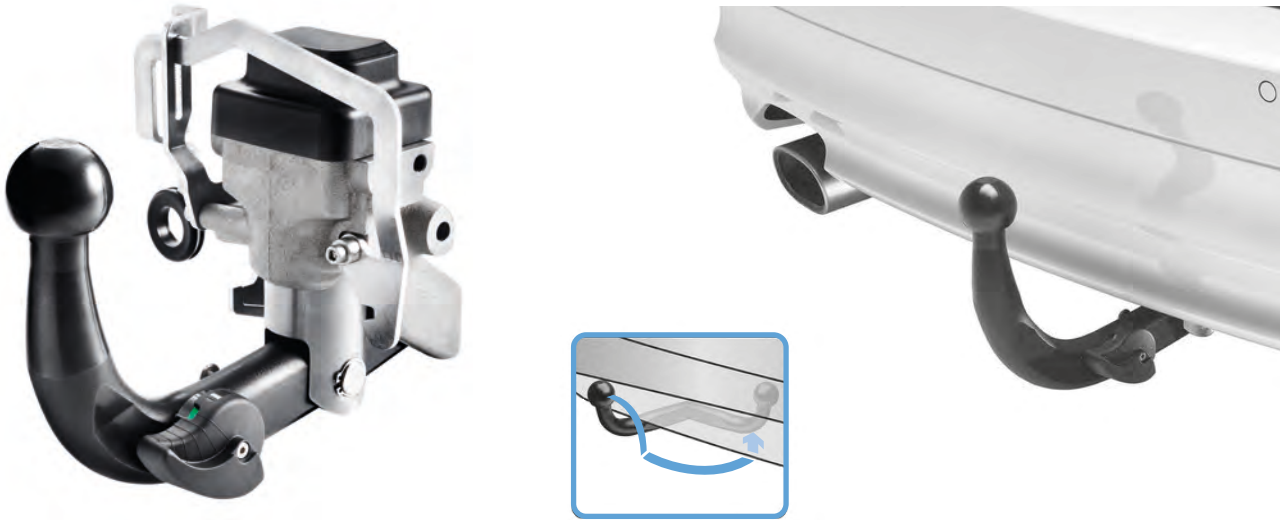

Ventajas:

- » Disponible de inmediato, tan sólo necesita 2 segundos.
- » Mantiene la estética del vehículo.
- » Bloqueo mediante presión, con indicación audible y visible Ergoclick™.
- » Mando SmartTurn™: funcionamiento seguro y fácil.
- » Se oculta detrás del paragolpes.
- » Una vez oculta, la bola nunca supone un obstáculo.
- » No precisa de llave de seguridad.



Kits Eléctricos Específicos

Diseñados para tu vehículo.

Para cada de enganche de remolque existe un kit eléctrico diseñado específicamente para el vehículo. Brink recomienda montar un kit eléctrico específico para garantizar el correcto funcionamiento de los elementos de seguridad (como el control de estabilidad ESP y el control de distancia de aparcamiento PDC) cuando se usa un remolque, caravana o portabicicletas.

Hay que tener presente que puede ser necesaria la activación de la función de remolque en el vehículo mediante la reprogramación de la unidad central del vehículo, consúltelo en las características del kit en nuestra web www.thu2.es.

¿Por qué un kit eléctrico específico?

- » Las Opciones de seguridad electrónica específicas de su vehículo (como ESP, PDC, etc.) funcionan correctamente.
- » Materiales de primera calidad para garantizar la fiabilidad operativa.
- » Sin interferencias con otros componentes electrónicos del automóvil.
- » Instrucciones de montaje claras y precisas.
- » Montaje personalizado específicamente para el vehículo.
- » Disponible para enchufes de 7 y 13 polos.

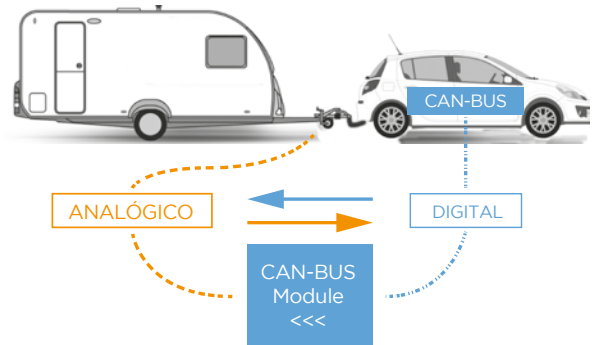

¿De qué elementos se compone un Kit específico Brink?

Partes

Para el usuario final, un kit eléctrico no es más que el enchufe para la conexión eléctrica junto a la bola de remolque. Sin embargo, se compone de muchas partes diferentes.



Kits Jaeger Flex 2in1

Con un kit específico JaegerFlex 2 in 1 no es necesario reprogramar el vehículo. Conectar y funcionar.



VENTAJAS

- No hay costes de programación.
- No hay mensajes de error tras la instalación.
- Función de iluminación de remolque completa.
- Aviso de fallo de intermitente activo.

DESVENTAJAS

- Desconexión de sensores de aparcamiento mediante interruptor.
- Desconexión de antiniebla en el vehículo no posible.
- Sistemas de asistencia a la conducción no se ajustan a la circulación con remolque.

Kit Universal con Módulo Electrónico



Seguridad + Garantía

Thu2 ofrece como una alternativa fiable y con garantía los kits eléctricos universales con módulo electrónico de gestión. La simplicidad en el montaje, precio y compatibilidad con los diferentes sistemas electrónicos que incorporan los automóviles los convierten en una opción interesante.

Compatibilidad

Este kit se puede instalar en la mayoría de turismos o vehículos comerciales con batería a 12V y 24V sin ninguna interacción en el sistema eléctrico y compatible con:

- » Sistemas de cable multiplexado BSI/PW (Luces con voltajes mixtos).
- » Sistemas Can Bus.
- » Check-Control (Detección de fallo en lámparas SFL).

Características

- » Cables de salida del módulo con sección de 0,75 mm.
- » Cables de entrada al módulo enfundados y con doble manguera
- » Cables de positivo y masa con sección de 2,5mm.
- » Conectores de reducido tamaño
- » Electrónica de alta seguridad. Está protegido contra posibles averías en el remolque, como cortocircuitos, y previene cualquier fallo o sobrecarga en el vehículo.
- » Conexiones preinstaladas que ahorran tiempo de montaje. Base de enchufe montada.
- » Función sustitutiva en caso de fallo en las lámparas de intermitencia del vehículo o accesorio remolcado.
- » Función para desconexión de las luces antiniebla del vehículo
- » Función para desconectar los sensores de aparcamiento PDC del vehículo cuando el remolque está conectado. (Según versión de kit y modelo de vehículo).

Garantías

- » Conforme a la directiva 2004/104/CE.
- » El kit tiene garantía de **2 años**.
- » El montaje del kit debe ser realizado en un taller especializado o por una persona cualificada.
- » Un uso inapropiado, la apertura del módulo, modificaciones en el kit o una instalación incorrecta, conllevan la anulación de la garantía.

Ref. 766113



NUEVO Kit 13 polos 8 funciones, Ref. 766213

Kit desarrollado para su uso con portabicicletas y remolques. Incluye conexión de luz de marcha atrás. No incluye cables de alimentación +30V y +15V.

Kit Electrónico Thu2					Precio (€)
Versiones					
766107	7	•	-	98,00	
766108	7	•	•	115,00	
766213*	13	•	-	110,00	
766113**	13	•	-	120,00	
766114**	13	•	•	135,00	

* Incluye conexión de luz de marcha atrás. No incluye cables de alimentación +30V y +15V.

** Incluye cables de alimentación +30V y +15V.

Kit Eléctrico con NFC

¿Qué permite este nuevo módulo con NFC?

Comprobamos cada día cómo avanza la tecnología que se incorpora a los vehículos. Hay una carrera por hacer que los componentes de nuestros vehículos consuman la menor cantidad de energía. El led, que se ya se incorporó hace unos años, contribuye a unos consumos energéticos muy bajos para alargar la durabilidad de las baterías y hoy existen leds de bajo consumo que ya incorporan algunos fabricantes de automóviles, por ejemplo las nuevas plataformas de Mercedes-Benz.

Esta nueva versión de nuestro módulo electrónico con NFC nos permite variar el parámetro de sensibilidad para la lectura de la intensidad que llega a los pilotos del vehículo.

¿Cómo funciona?

Lo primero que necesitamos es un smartphone o tablet Android con tecnología NFC, instalamos en el mismo la aplicación **Thu2 Kit** desde el Play Store, en ajustes, activamos NFC, abrimos la aplicación, acercamos nuestro smartphone a la zona NFC del módulo electrónico para enlazarlos y procedemos a programar el módulo. Podemos variar la sensibilidad de cada canal, cambiar un canal por otro, activar la desconexión de antiniebla, seleccionar la programación de un vehículo concreto o restaurar los valores predeterminados.

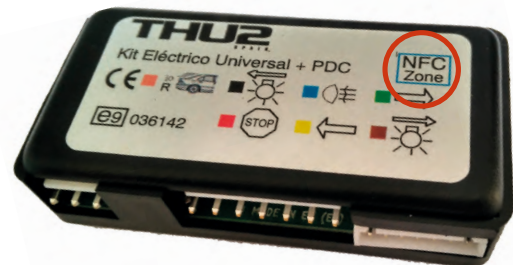

INSTALACIÓN DE APLICACIÓN



ENLAZAMOS EL MÓDULO



PANTALLA DE MENÚ

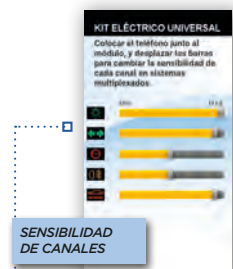

SENSIBILIDAD DE CANALES



SELECCIÓN VEHÍCULO











































ASIGNACIÓN DE FUNCIONES

Versiones disponibles

Al igual que el modelo estándar, tenemos disponibles 4 versiones de este nuevo módulo según sus prestaciones y características.



































Kit electrónico Thu2 con NFC					Precio (€)
Versiones	766109	7	•	–	102,00
	766101	7	•	•	115,00
	766119**	13	•	–	120,00
	766111**	13	•	•	135,00









































** Incluye cables de alimentación +30V y +15V.

Datos vehículo		Datos enganche							Datos kit eléctrico						
 		       							         						
ALFA ROMEO															
147 (excluido GTA)	11/2000 - 03/2010	476400	Cisne		275,00 ◦	1300	7,83	60	C	766107	U 7	98,00	F •		
		476500	BMC		455,00 ◦	1300	7,83	60	C	766113	U 13	120,00	G •		
156	09/1997 - 07/2003	395700 *	Cisne		230,00	1450	8,66	60	C	766107	U 7	98,00	F •		
	09/1997 - 09/2005	395800 *	BMC		440,00	1450	8,66	60	C	766113	U 13	120,00	G •		
156 Sportwagon (excluido Q4)	01/2000 - 07/2003	395700 *	Cisne		230,00	1450	8,66	60	C	766107	U 7	98,00	F •		
	08/2003 - 05/2006	395800 *	BMC		440,00	1400	8,66	60	C	766113	U 13	120,00	G •		
159	09/2005 - 11/2011	476600	Cisne		265,00 ◦	1800	9,90	75	C	766107	U 7	98,00	F •		
		476700	BMC		445,00 ◦	1800	9,90	75	C	766113	U 13	120,00	G •		
159 Sportwagon	03/2006 - 11/2011	476600	Cisne		265,00 ◦	1800	9,90	75	C	766107	U 7	98,00	F •		
		476700	BMC		445,00 •	1800	9,90	75	C	766113	U 13	120,00	G •		
159 Sportwagon Q4	03/2006 - 11/2011	476600	Cisne		265,00 ◦	1800	9,90	75	C	766107	U 7	98,00	F •		
		476700	BMC		445,00 •	1800	9,90	75	C	766113	U 13	120,00	G •		
Giulia (sólo versión diesel)(excluido Veloce)	10/2015 -	620500 *	Cisne		230,00 •	1600	9,10	100	C	766107	U 7	98,00	F •		
		620600 *	BMU		400,00 •	1600	9,10	100	C	766113	U 13	120,00	G •		
Giulia (incluido diesel y gasolina)(excluido Veloce) (631700: se aconseja colocar tapa paragolpes ref. 50549357)	10/2015 -	631600	Cisne		230,00 •	1600	9,10	100	C	766107	U 7	98,00	F •		
		631700	BMU		440,00 •	1600	9,10	100	C	766113	U 13	120,00	G •		
Giulietta	04/2010 -	532100	Cisne		230,00 ◦	1500	8,00	90	C	766107	U 7	98,00	F •		
		532200	BMAh		410,00 ◦	1500	8,00	90	C	766113	U 13	120,00	G •		
MiTo	09/2008 -	498500	BMA		420,00 ◦	1000	6,70	60	C	766107	U 7	98,00	F •		
										766113	U 13	120,00	G •		
Stelvio (incluido 4WD)	01/2017 -	632700	Cisne		260,00 ◦	2300	11,50	90	C	766107	U 7	98,00	F •		
		632800	BMU		470,00 ◦	2300	11,50	90	C	766113	U 13	120,00	G •		









































Datos vehículo		Datos enganche							Datos kit eléctrico						
AUDI															
A1 (8X1,8XK) (531900, incluido S-Line) (625200, incluido S-Line, se aconseja cambiar paragolpes)	05/2010 - 10/2018	531900	Cisne		200,00	◦	1200	7,00	85	B	766107	U 7	98,00	F •	
		625200	BMU		410,00	•	1200	7,20	86	B	766113	U 13	120,00	G •	
A1 Sportback 5 puertas (8X1,8XF) (531900, incluido S-Line) (625200, incluido S-Line, se aconseja cambiar paragolpes)	09/2011 - 10/2018	531900	Cisne		200,00	◦	1200	7,00	85	B	766107	U 7	98,00	F •	
		625200	BMU		410,00	•	1200	7,20	86	B	766113	U 13	120,00	G •	
A3 3 puertas (8L1) (excluido Quattro)	09/1996 - 05/2003	524900	Cisne		170,00		1500	8,00	75	A	766007	U 7	13,50	E	
											766013	U 13	39,50	F	
A3 3 puertas (8P1) (excluido S-Line, Cabrio)	07/2008 - 07/2012	509700	Cisne		187,00	•	1800	9,00	100	B	766107	U 7	98,00	F •	
		509800	BMA		367,00	•	1800	9,00	100	B	766113	U 13	120,00	G •	
A3 3 puertas (8V1) (excluido Quattro, S-Line, S3) (606500: vehic. sin tapa cambiar spoiler inferior paragolpes o recorte visto) (1 escape: 8V3.807.521A; 2 escapes: 8V3.807.521C)	08/2012 - 06/2016	567000	Cisne		180,00	•	1900	9,90	80	B	766107	U 7	98,00	F •	
		606500	BMU		395,00	•	2000	10,30	85	B	766113	U 13	120,00	G •	
A3 Cabrio (8V7/8VE) (incluido S-Line) (606500: S-Line cambiar spoiler paragolpes o recorte visto)	10/2013 - 06/2016	606500	BMU		395,00		2000	10,30	85	B	766107	U 7	98,00	F •	
											766113	U 13	120,00	G •	
A3 Cabrio (8V7/8VE) (incluido S-Line) (excluido Quattro)	07/2016 -	643700	Cisne		209,00	◦	2000	10,30	85	B	766107	U 7	98,00	F •	
		621500	BMU		409,00	◦	2000	10,30	85	B	766113	U 13	120,00	G •	
A3 Sedán (8VS/8VM) (incluido S-Line) (excluido S3)	05/2013 - 06/2016	643700	Cisne		209,00		2000	9,90	80	B	766107	U 7	98,00	F •	
		606500	BMU		395,00	•	2000	10,30	85	B	766113	U 13	120,00	G •	
A3 Sedán (8VS) (incluido S-Line)	07/2016 -	643700	Cisne		209,00	◦	2000	10,30	85	B	766107	U 7	98,00	F •	
		621500	BMU		409,00	◦	2000	10,30	85	B	766113	U 13	120,00	G •	
										701474	3 13	210,00	H • • ◦ ◦ B E		
										701504	4 13	179,00	H • • ◦ ◦ C N		
										701524	4 13	225,00	G • • D D C E		
										701524	4 13	225,00	G • • D D C E		

* Hasta finalización de stock

Datos vehículo		Datos enganche								Datos kit eléctrico							
 		       								          							
A3 Sportback 5 puertas (8PA) (incluido Quattro) (excluido S-Line)	09/2004 - 06/2008	441000	Cisne		229,00 •	1800	9,60	75	B	766107	U 7	98,00	F •				
		451700	BMA		409,00 •	1800	9,60	75	B	766113	U 13	120,00	G •				
A3 Sportback 5 puertas (8PA) (excluido S-Line)	07/2008 - 03/2013	509700	Cisne		187,00 •	1800	9,00	100	B	766107	U 7	98,00	F •				
		509800	BMA		367,00 •	1800	9,00	100	B	766113	U 13	120,00	G •				
										701414	13	240,00	H • • D D C E				
A3 Sportback 5 puertas (8VA) (Cisne incluido S-Line, G-tron, E-tron) (570900: excluido S-Line) (606500: incluido G-tron, E-tron y en S-Line cambiar spoiler paragolpes o recorte visto)	09/2012 - 06/2016	643700	Cisne		209,00 •	1900	9,90	80	B	766107	U 7	98,00	F •				
		570900 *	BMA		390,00 •	1900	9,90	80	B	766113	U 13	120,00	G •				
		606500	BMU		395,00 •	2000	10,30	85	B	701504	4 13	179,00	H • • ° ° C N				
A3 Sportback 5 puertas (8VA) (incluido S-Line)	07/2016 -	643700	Cisne		209,00 °	2000	10,30	85	B	766107	U 7	98,00	F •				
		621500	BMU		409,00	2000	10,30	85	B	766113	U 13	120,00	G •				
A3 Sportback 5 puertas	03/2020 -								701524	4 13	225,00	G • • D D C E					
									766107	U 7	98,00	F •					
A4 Berlina (8D2,B5) (incluido Quattro)	11/1994 - 03/1999	268500	Cisne		280,00 °	1800	9,50	75	B	766007	U 7	13,50	E				
									766013	U 13	39,50	F					
A4 Berlina (8E2,B6) (518300: incluido Quattro, S-Line) (403100: incluido Quattro, excluido S-Line)	11/2000 - 11/2004	518300	Cisne		209,00 °	2000	10,40	80	B	766107	U 7	98,00	F •				
		403100	BMC		389,00 °	2000	10,20	80	B	766113	U 13	120,00	G •				
A4 Berlina (8EC,B7) (incluido Quattro, S-Line)	11/2004 - 06/2008	518300	Cisne		209,00 °	2000	10,40	80	B	766107	U 7	98,00	F •				
		440400	BMA		419,00 •	2000	10,40	80	B	766113	U 13	120,00	G •				









































Datos vehículo		Datos enganche								Datos kit eléctrico																														
																																								
A4 Berlina (8K2,B8) (492500, 492600: incluido S-Line) (493200: excluido S-Line) (618900: incluido S-Line, Quattro)	11/2007 - 10/2015	492500	Cisne		215,00	◦	2100	11,00	90	B	766107	U	7	98,00	F	•																								
		492600	BMA		395,00	•	2100	11,00	90	B	766113	U	13	120,00	G	•																								
		618900	BMU		435,00	◦	2100	11,10	90	B	701463	4	7	194,00	G	•	•	D	D	G	G																			
		493200	MX		865,00	•	2100	11,00	90	B	701464	4	13	204,00	G	•	•	D	D	C	E																			
A4 Berlina (8W2,B9) (incluido S-Line, Quattro)	11/2015 - 11/2019	610800	Cisne		215,00	◦	2100	11,00	90	B	766107	U	7	98,00	F	•																								
		610900	BMU		425,00	◦	2100	11,00	90	B	766113	U	13	120,00	G	•																								
		611000	MX		865,00	◦	2100	11,00	90	B	701514	4	13	195,00	G	•	•	D/Z	D	C	N																			
A4 Berlina (8W2,B9) (incluido S-Line)	12/2019 -	610800	Cisne		215,00	◦	2100	11,00	90	B	701514	4	13	195,00	G	•	•	D/Z	D	C	N																			
		610900	BMU		425,00	◦	2100	11,00	90	B																														
A4 Avant (8D5,B5) (incluido Quattro)	11/1994 - 03/1999	268500	Cisne		280,00	◦	1800	9,50	75	B	766007	U	7	13,50	E																									
											766013	U	13	39,50	F																									
A4 Avant (8E5,B6) (incluido Quattro, S-Line)	04/2001 - 11/2004	518300	Cisne		209,00	◦	2000	10,40	80	B	766107	U	7	98,00	F	•																								
		403100	BMC		389,00	◦	2000	10,00	80	B	766113	U	13	120,00	G	•																								
A4 Avant (8ED,B7) (incluido Quattro, S-Line)	11/2004 - 06/2008	518300	Cisne		209,00	◦	2000	10,40	80	B	766107	U	7	98,00	F	•																								
		440400	BMA		419,00	•	2000	10,40	80	B	766113	U	13	120,00	G	•																								
A4 Avant (8K5,B8) (492500, 492600, 618900: incluido S-Line, Allroad) (493200: excluido S-Line, Allroad)	11/2007 - 12/2015	492500	Cisne		215,00	◦	2100	11,00	90	B	766107	U	7	98,00	F	•																								
		492600	BMA		395,00	•	2100	11,00	90	B	766113	U	13	120,00	G	•																								
		618900	BMU		435,00	◦	2100	11,10	90	B	701463	4	7	194,00	G	•	•	D	D	G	G																			
		493200	MX		865,00	•	2100	11,00	90	B	701464	4	13	204,00	G	•	•	D	D	C	E																			
A4 Avant (8W5,B9) (incluido S-Line, Quattro, apertura maletero con pie)	11/2015 - 11/2019	610800	Cisne		215,00	◦	2100	11,00	90	B	766107	U	7	98,00	F	•																								
		610900	BMU		425,00	◦	2100	11,00	90	B	766113	U	13	120,00	G	•																								
		611000	MX		865,00	◦	2100	11,00	90	B	701514	4	13	195,00	G	•	•	D/Z	D	C	N																			

































* Hasta finalización de stock

Datos vehículo		Datos enganche								Datos kit eléctrico												
 		       								         												
A4 Avant (8W5,B9) (incluido S-Line)	12/2019 -	610800	Cisne		215,00	◦	2100	11,00	90	B	701514	4	13	195,00	G	•	•	D/Z	D	C	N	
		610900	BMU		425,00	◦	2100	11,00	90	B												
A4 Cabrio (8H7,B6,8HE,B7)	04/2002 - 03/2009	518300	Cisne		209,00	◦	2000	10,40	80	B	766107	U	7	98,00	F	•						
		440400	BMA		419,00	•	2000	10,40	80	B	766113	U	13	120,00	G	•						
A5 Cabrio (8F7) (incluido S-Line, Quattro)	03/2009 - 03/2017	492500	Cisne		215,00	◦	2100	11,00	90	B	766107	U	7	98,00	F	•						
		492600	BMA		395,00	•	2100	11,00	90	B	766113	U	13	120,00	G	•						
		618900	BMU		435,00	◦	2100	11,10	90	B	701463	4	7	194,00	G	•	•	D	D	G	G	
										701464	4	13	204,00	G	•	•	D	D	C	E		
A5 Coupé (8T3) (incluido S-Line, Quattro)	06/2007 - 12/2016	492500	Cisne		215,00	◦	2100	11,00	90	B	766107	U	7	98,00	F	•						
		492600	BMA		395,00	•	2100	11,00	90	B	766113	U	13	120,00	G	•						
		618900	BMU		435,00	◦	2100	11,10	90	B	701463	4	7	194,00	G	•	•	D	D	G	G	
										701464	4	13	204,00	G	•	•	D	D	C	E		
A5 Sportback 5 puertas (8TA) (incluido S-Line, Quattro)	03/2009 - 12/2016	492500	Cisne		215,00	◦	2100	11,00	90	B	766107	U	7	98,00	F	•						
		492600	BMA		395,00	•	2100	11,00	90	B	766113	U	13	120,00	G	•						
		618900	BMU		435,00	◦	2100	11,10	90	B	701463	4	7	194,00	G	•	•	D	D	G	G	
										701464	4	13	204,00	G	•	•	D	D	C	E		
A5 Sportback 5 puertas (5F) (incluido S-Line, Quattro)	01/2017 - 11/2019	610800	Cisne		215,00	◦	2100	11,00	90	B	766107	U	7	98,00	F	•						
		610900	BMU		425,00	◦	2000	11,10	90	B	766113	U	13	120,00	G	•						
										701514	4	13	195,00	G	•	•	D/Z	D	C	N		
A5 Sportback 5 puertas (5F) (incluido S-Line)	12/2019 -	610800	Cisne		215,00	◦	2100	11,00	90	B	701514	4	13	195,00	G	•	•	D/Z	D	C	N	
		610900	BMU		425,00	◦	2000	11,10	90	B												
A6 Allroad (4GH,4GJ)	01/2012 - 09/2018	550800	BMA		425,00	◦	2500	12,60	100	C	766107	U	7	98,00	F	•						
		545500	MX		865,00	◦	2500	12,60	100	C	766113	U	13	120,00	G	•						
										701484	4	13	210,00	H	•	•	D	D	C	E		
A6 Berlina (4B2,C5) (excluido V8, Quattro, con PDC)	01/1997 - 12/2004	279700	Cisne		259,00	◦	2100	10,90	85	B	766107	U	7	98,00	F	•						
										766113	U	13	120,00	G	•							

Datos vehículo		Datos enganche							Datos kit eléctrico						
A6 Berlina (4F2,C6) (incluido Quattro) (excluido S-Line, con regulador de nivel)	05/2004 - 03/2011	511700	Cisne		240,00 •	2100	10,90	85	B	766107	U	7	98,00	F	•
		439900	BMA		510,00 •	2100	11,20	85	B	766113	U	13	120,00	G	•
		470600	MX		890,00 °	2100	10,90	85	B	701424		13	230,00	H	• • ° ° C E
A6 Berlina (4G2,C7,4GC) (incluido Quattro, S-Line) (excluido con regulador de nivel, Hybrid)	11/2010 - 07/2018	550700	Cisne		215,00	2100	12,60	85	B	766107	U	7	98,00	F	•
		550800	BMA		425,00	2500	12,60	100	B	766113	U	13	120,00	G	•
		589500	BMU		440,00	2500	12,60	100	B	701484	4	13	210,00	H	• • D D C E
		545500	MX		865,00 °	2500	12,60	100	B						
A6 Berlina (4A2,C8) (incluido apertura maletero con pie)	09/2018 -	656800	Cisne		250,00	2000	12,00	95	B	766107	U	7	98,00	F	•
		656900	BMU		460,00	2000	12,00	95	B	766113	U	13	120,00	G	•
									701554		13	180,00	G	• • ° ° C N	
A6 Avant (4B5,C5) (279700: excluido V8, Quattro, con PDC) (468600: excluido V8, Quattro)	11/1997 - 01/2005	279700	Cisne		259,00 °	2100	10,90	85	B	766107	U	7	98,00	F	•
									766113	U	13	120,00	G	•	
A6 Avant (4F5,C6) (incluido Quattro) (excluido S-Line, con regulador de nivel)	02/2005 - 08/2011	511700	Cisne		240,00 •	2100	10,90	85	B	766107	U	7	98,00	F	•
		439900	BMA		510,00 •	2100	11,20	85	B	766113	U	13	120,00	G	•
		470600	MX		890,00 °	2100	10,90	85	B	701424		13	230,00	H	• • ° ° C E
A6 Avant (4G5,C7,4GD) (incluido Quattro, S-Line) (excluido con regulador de nivel, Hybrid)	11/2010 - 07/2018	550700	Cisne		215,00	2100	12,60	85	B	766107	U	7	98,00	F	•
		550800	BMA		425,00	2500	12,60	100	B	766113	U	13	120,00	G	•
		589500	BMU		440,00	2500	12,60	100	B	701484	4	13	210,00	H	• • D D C E
		545500	MX		865,00 °	2500	12,60	100	B						
A6 Avant (4A5,C8)	09/2018 -	656800	Cisne		250,00	2000	12,00	95	B	766107	U	7	98,00	F	•
		656900	BMU		460,00	2000	12,00	95	B	766113	U	13	120,00	G	•
									701554		13	180,00	G	• • ° ° C N	
A7 Sportback (4GA,4GF) (incluido Quattro) (550800: excluido S-Line) (589500 y 545100: incluido S-Line)	10/2010 - 08/2018	550800	BMA		415,00 °	2500	12,60	100	B	766107	U	7	98,00	F	•
		589500	BMU		440,00	2500	12,60	100	B	766113	U	13	120,00	G	•
		545100	MX		865,00 °	2500	12,60	100	B	701484	4	13	210,00	H	• • D D C E
A7 Sportback (4KA) (incluido apertura maletero con pie)	09/2018 -	656800	Cisne		250,00	2000	10,90	95	B	766107	U	7	98,00	F	•
		656900	BMU		460,00	2000	10,90	95	B	766113	U	13	120,00	G	•
									701554		13	180,00	G	• • ° ° C N	

* Hasta finalización de stock















































Datos vehículo		Datos enganche									Datos kit eléctrico								
 		        									           								
Q2 (GA) (incluido S-Line, Quattro)	06/2016 -	628200	Cisne		205,00	1850	9,80	75	B	766107	U	7	98,00	F	•				
		628300	BMU		415,00	1850	9,80	75	B	766113	U	13	120,00	G	•				
										701524	4	13	225,00	G	• • D D C E				
Q3 (8U) (incluido S-Line) (modelo 08/2016- , no es necesario recorte paragolpes) (excluido RS Quattro)	06/2011 - 12/2018	666000	Cisne		239,00	2500	12,60	100	B	766107	U	7	98,00	F	•				
		666100	BMU		459,00	2500	12,60	100	B	766113	U	13	120,00	G	•				
										701414		13	240,00	H	• • D D C E				
Q3 (F3) (incluido S-Line)	01/2019 -	666200	Cisne		239,00	2200	11,00	90	B	766107	U	7	98,00	F	•				
		666300	BMU		459,00	2200	11,00	90	B	766113	U	13	120,00	G	•				
										701524	4	13	225,00	G	• • D D C E				
Q5 (8R) (incluido S5, SQ5 y Hybrid, S-Line)	11/2008 - 12/2016	513800	Cisne		250,00	2400	12,00	80	B	766107	U	7	98,00	F	•				
		513900	BMA		430,00	2400	12,00	80	B	766113	U	13	120,00	G	•				
		592300	BMU		570,00	2400	12,20	80	B	701463	4	7	194,00	G	• • D D G G				
										701464	4	13	204,00	G	• • D D C E				
Q5 (FY) (incluido S-Line, Quattro) (632500, incluido apertura maletero con pie)	01/2017 -	632400	Cisne		220,00	2400	12,50	100	B	766107	U	7	98,00	F	•				
		632500	BMU		425,00	2400	12,50	100	B	766113	U	13	120,00	G	•				
		632600	MX		900,00	2400	12,20	100	B	701514	4	13	195,00	G	• • D/Z D C N				
Q7 (4L) (excluido vehic. con tapa en el paragolpes, S-Line) (excluido vehic. con techo panorámico)	03/2006 - 08/2015	359000	Cisne		379,00	3500	16,40	140	B	766107	U	7	98,00	F	•				
		461400	BMA		489,00	3500	16,40	140	B	766113	U	13	120,00	G	•				
										701434		13	270,00	H	• • ◦ ◦ B E				
Q7 (4L/4M)	09/2015 -	660100	Cisne		480,00	3500	16,40	140	B	766107	U	7	98,00	F	•				
		606400 *	BMAh		500,00	3500	16,40	140	B	766113	U	13	120,00	G	•				
		655700	BMU		660,00	3500	16,40	140	B	701514	4	13	195,00	G	• • D/Z D C N				

Datos vehículo		Datos enganche						Datos kit eléctrico																											
																																			
BMW																																			
Serie 1 Coupé (E82) (excluido Kit M, 135i, Cabrio) (comprobar MMR)		10/2007 - 11/2013	444600	BMA		419,00	◦	1900	10,00	75	B	766107	U	7	98,00	F	•																		
												766113	U	13	120,00	G	•																		
												703324		13	199,00	F	•	•	•	•	•	C	N												
Serie 1 3 puertas (E81) (incluido Kit M) (comprobar MMR)		09/2006 - 09/2012	444600	BMA		419,00	◦	1900	10,00	75	B	766107	U	7	98,00	F	•																		
												766113	U	13	120,00	G	•																		
												703324		13	199,00	F	•	•	•	•	•	C	N												
Serie 1 3 puertas (F21) (incluido Efficient Dynamics) (excluido Kit M, 116i, 118i, 125i, 135i del 05/2014 -) (excluido Kit M, 120i del 09/2015 -) (comprobar MMR)		01/2012 - 12/2019	549500	Cisne		190,00		1600	8,80	75	B	766107	U	7	98,00	F	•																		
			549600 *	BMA		370,00	•	1600	8,80	75	B	766113	U	13	120,00	G	•																		
			617900	BMU		415,00		2000	10,45	80	B	703374		13	-02/2014	225,00	G	•	•	•	•	C	E												
												747372		13	03/2014-	175,00	G	•	•	•	•	D	C	N											
Serie 1 5 puertas (E87) (incluido Kit M) (comprobar MMR)		11/2003 - 12/2012	444600	BMA		419,00	◦	1900	10,00	75	B	766107	U	7	98,00	F	•																		
												766113	U	13	120,00	G	•																		
												703324		13	199,00	F	•	•	•	•	•	C	N												
Serie 1 5 puertas (F20) (incluido Efficient Dynamics) (excluido Kit M, 116i, 118i, 125i, 135i del 05/2014 - 11/2016) (excluido Kit M / 120i del 09/2015 - 10/2016) (comprobar MMR)		11/2010 - 12/2019	549500	Cisne		190,00		1600	8,80	75	B	766107	U	7	98,00	F	•																		
			549600 *	BMA		370,00	•	1600	8,80	75	B	766113	U	13	120,00	G	•																		
			617900	BMU		415,00		2000	10,45	80	B	703374		13	-02/2014	225,00	G	•	•	•	•	C	E												
												747372		13	03/2014-	175,00	G	•	•	•	•	D	C	N											
Serie 1 5 puertas (F40) (incluido Kit M)		01/2020 -	678500	Cisne		229,00	◦	2000	10,20	80	B	766107	U	7	98,00	F	•																		
			678600	BMU		419,00	◦	200	10,20	80	B	766113	U	13	120,00	G	•																		
Serie 2 Active Tourer (F45) (incluido Kit M, apertura maletero con pie)		09/2014 -	617900	BMU		415,00		2000	10,45	80	B	766107	U	7	98,00	F	•																		
												766113	U	13	120,00	G	•																		
												703474		13	160,00	G	•	•	•	•	•	C	N												
Serie 2 Grand Tourer (F46) (incluido apertura maletero con pie) (614000, excluido Kit M) (617900, incluido Kit M)		03/2015 -	614000	Cisne		200,00		1600	9,50	75	B	766107	U	7	98,00	F	•																		
			617900	BMU		415,00		2000	10,45	80	B	766113	U	13	120,00	G	•																		
												703478		13	160,00	G	•	•	•	•	•	C	N												

* Hasta finalización de stock



























Datos vehículo		Datos enganche								Datos kit eléctrico						
Serie 3 Coupé (E36) (excluido Kit M)	03/1992 - 04/1999	192000	Cisne		250,00 *	1800	9,00	75	B	766007	U	7	13,50	E		
										766013	U	13	39,50	H		
Serie 3 Coupé (E46) (excluido Kit M)	04/1999 - 07/2006	384500	Cisne		265,00 °	1800	9,00	75	B	766107	U	7	98,00	F •		
										766113	U	13	120,00	G •		
3 Gran Turismo (F34) (excluido Kit M)	03/2013 -	581800	BMU		565,00	1800	10,50	75	B	766107	U	7	98,00	F •		
										766113	U	13	120,00	G •		
										703374	13	-02/2014	225,00	G • • • D C N		
										747373	13	03/2014-	175,00	G • • • D C N		
Serie 3 Touring (E36) (excluido Kit M)	01/1995 - 10/1999	192000	Cisne		250,00 *	1800	9,00	75	B	766007	U	7	13,50	E		
										766013	U	13	39,50	H		
Serie 3 Touring (E46) (excluido Kit M)	10/1999 - 02/2005	347000	Cisne		270,00 °	1800	9,50	75	B	766107	U	7	98,00	F •		
		447100	BMA		450,00 °	1800	9,50	75	B	766113	U	13	120,00	G •		
Serie 3 Touring (E91) (incluido Kit M) (excluido 335i, 335d) (comprobar MMR)	09/2005 - 06/2012	444500	Cisne		205,00 °	1900	10,00	75	B	766107	U	7	98,00	F •		
		444600	BMA		419,00 °	1900	10,00	75	B	766113	U	13	120,00	G •		
		470800	MX		855,00 °	1900	10,00	75	B	703324	13		199,00	F • • • • C N		
Serie 3 Touring (F31) (incluido Kit M / X-Drive) (comprobar MMR)	10/2011 - 06/2019	554400	Cisne		205,00	1700	10,00	75	B	766107	U	7	98,00	F •		
		617900	BMU		415,00	2000	10,45	80	B	766113	U	13	120,00	G •		
		586200	MX		885,00 °	1800	10,00	75	B	703374	13	-02/2014	225,00	G • • • • C E		
									747372	13		175,00	G • • • D C N			
Serie 3 Touring (G21) (667800, 667900: incluido Kit M) (668000, incluido Adblue) (comprobar MMR)	10/2019 -	667800	Cisne		235,00 °	1800	10,50	75	B	766107	U	7	98,00	F •		
		667900	BMU		500,00 °	1800	10,50	80	B	766113	U	13	120,00	G •		
		668000	MX		915,00 °	1800	10,50	75	B	747375	13		175,00	G • • • D C N		

* Hasta finalización de stock

Datos vehículo		Datos enganche										Datos kit eléctrico									
 		         										          									
Serie 4 Cabrio (F33,F83) (incluido Kit M)	10/2013 -	554400	Cisne		205,00	1800	10,00	75	B	766107	U	7	98,00	F	•						
		617900	BMU		415,00	2000	10,45	80	B	766113	U	13	120,00	G	•						
		586200	MX		885,00 ◦	1800	10,00	75	B	747372		13	175,00	G	• • • D C N						
Serie 4 Coupe (F32,F82) (incluido Kit M)	07/2013 -	554400	Cisne		205,00	1800	10,00	75	B	766107	U	7	98,00	F	•						
		617900	BMU		415,00	2000	10,45	80	B	766113	U	13	120,00	G	•						
		586200	MX		885,00 ◦	1800	10,00	75	B	747372		13	175,00	G	• • • D C N						
Serie 4 Gran Coupe (F36) (incluido Kit M)	03/2014 -	554400	Cisne		205,00	1800	10,00	75	B	766107	U	7	98,00	F	•						
		617900	BMU		415,00	2000	10,45	80	B	766113	U	13	120,00	G	•						
		586200	MX		885,00 ◦	1800	10,00	75	B	747372		13	175,00	G	• • • D C N						
Serie 5 Berlina (E39) (excluido con PDC, kit M)	11/1995 - 06/2003	232100	Cisne		260,00 •	2200	11,40	75	B	766107	U	7	98,00	F	•						
										766113	U	13	120,00	G	•						
Serie 5 Berlina (E60) (excluido Kit M)	07/2003 - 03/2010	411100	Cisne		250,00 ◦	2200	11,40	90	B	766107	U	7	98,00	F	•						
		488200	BMA		445,00 ◦	2200	11,40	90	B	766113	U	13	120,00	G	•						
		471500	MX		930,00 ◦	2200	11,40	90	B	703324		13	199,00	F	• • • • C N						
Serie 5 Berlina (F10) (incluido Kit M, Xdrive) (excluido M5)	03/2010 - 01/2017	528700	Cisne		215,00 ◦	2200	11,80	100	B	766107	U	7	98,00	F	•						
		604100	BMU		475,00 ◦	2200	11,80	100	B	766113	U	13	120,00	G	•						
		528900	MX		895,00 ◦	2200	11,80	100	B	703374		13	-02/2014	225,00	G	• • • • C E					
									747373		13	03/2014-	175,00	G	• • • D C N						
Serie 5 Berlina (G30,F90) (incluido Kit M, apertura maletero con pie) (excluido M5)	02/2017 -	631800	Cisne		230,00 ◦	2000	11,50	90	B	766107	U	7	98,00	F	•						
		648000	BMU		440,00 ◦	2000	11,50	90	B	766113	U	13	120,00	G	•						
		648100	MX		910,00 ◦	2000	11,50	90	B	747374		13	175,00	G	• • • D C N						
Serie 5 Touring (E39) (excluido con regulador de nivel, M5) (452200: incluido tapa paragolpes)	01/1997 - 05/2004	248100	Cisne		280,00 •	2200	11,40	75	B	766107	U	7	98,00	F	•						
		452200	BMA		540,00 •	2200	11,40	75	B	766113	U	13	120,00	G	•						
Serie 5 Touring (E61) (excluido Kit M)	06/2004 - 12/2011	411100	Cisne		250,00 ◦	2200	11,40	90	B	766107	U	7	98,00	F	•						
		488200	BMA		441,00 ◦	2200	11,40	90	B	766113	U	13	120,00	G	•						
		471500	MX		930,00 ◦	2200	11,40	90	B	703324		13	199,00	F	• • • • C N						

Datos vehículo		Datos enganche								Datos kit eléctrico							
Serie 5 Touring (F11) (incluido Kit M, Xdrive) (528900: excluido apertura remota)	04/2010 - 04/2017	528700	Cisne		215,00	2200	11,80	100	B	766107	U	7	98,00	F	•		
		604100	BMU		475,00	2200	11,80	100	B	766113	U	13	120,00	G	•		
		528900	MX		895,00	2200	11,80	100	B	703374	13	-02/2014	225,00	G	• • • • C E		
Serie 5 Touring (G31) (incluido Kit M, apertura maletero con pie) (excluido M5)	05/2017 -	647900	Cisne		230,00	2000	11,50	90	B	766107	U	7	98,00	F	•		
		648000	BMU		440,00	2000	11,50	90	B	766113	U	13	120,00	G	•		
		648100	MX		910,00	2000	11,50	90	B	747374	13	03/2014-	175,00	G	• • • D C N		
Serie 6 Gran Turismo (G32) (incluido Kit M, apertura maletero con pie) (excluido M5)		648000	BMU		440,00	2000	11,50	90	B	766107	U	7	98,00	F	•		
									766113	U	13	120,00	G	•			
									747374	13		175,00	G	• • • D C N			
Serie 7 (E38) (incluido tapa paragolpes)	10/1994 - 11/2001	436800	BMC		519,00	2200	11,80	90	C	766107	U	7	98,00	F	•		
									766113	U	13	120,00	G	•			
X1 (E84) (incluido X-Drive) (excluido Kit M) (525100: incluido Kit M, excluido con PDC)	03/2009 - 10/2015	525100	Cisne		200,00	2000	10,23	80	B	766107	U	7	98,00	F	•		
	03/2009 - 10/2015	525200	BMA		380,00	2000	10,23	80	B	766113	U	13	120,00	G	•		
	03/2009 - 10/2015	622800	BMU		450,00	2000	10,23	80	B	703364	13		210,00	G	• • • • C N		
	03/2009 - 05/2012	525300	MX		880,00	2000	10,23	80	B								
X1 (F48) (incluido Kit M, Sport Line, xLine) (617900, incluido apertura maletero con pie) (614600, incluido apertura maletero con pie)	11/2015 -	614000	Cisne		200,00	2000	10,45	80	B	766107	U	7	98,00	F	•		
		617900	BMU		415,00	2000	10,45	80	B	766113	U	13	120,00	G	•		
		614600	MX		880,00	2000	10,45	80	B	703474	13		160,00	G	• • • • C N		
X2 (F39) (incluido Kit M)	03/2018 -	651300	Cisne		195,00	2000	10,50	80	B	766107	U	7	98,00	F	•		
		651400	BMU		410,00	2000	10,50	80	B	766113	U	13	120,00	G	•		
									703474	13		160,00	G	• • • D C N			

* Hasta finalización de stock

Datos vehículo		Datos enganche										Datos kit eléctrico																							
																																			
X3 (E83) (excluido Kit M) (excluido modelos preparados para portabicicletas)	10/2003 - 12/2011	420700	BMA		425,00	2000	10,70	80	B	766107	U	7	98,00	F	•	766113	U	13	120,00	G	•	703334	13	215,00	H	•	•	•	C	E					
X3 (F25) (incluido X-Drive) (excluido Kit M)	09/2010 - 02/2014	536100	Cisne		235,00	2400	11,70	100	B	766107	U	7	98,00	F	•	766113	U	13	120,00	G	•	703374	13	225,00	G	•	•	•	C	E					
X3 (F25) (incluido X-Drive) (excluido Kit M) (656300, 536200, 601200 excluido Kit M) (656400 incluido Kit M)	03/2014 - 11/2017	656300	Cisne		255,00	2400	12,00	100	B	766107	U	7	98,00	F	•	766113	U	13	120,00	G	•	747373	13	175,00	G	•	•	•	D	C	N				
X3 (G01) (incluido Kit M) (648500, 648600 incluido apertura maletero con pie) (648700 excluido apertura maletero con pie)	12/2017 -	648500 *	Cisne		245,00	2400	12,00	100	B	766107	U	7	98,00	F	•	766113	U	13	120,00	G	•	747374	13	175,00	G	•	•	•	D	C	N				
X4 (F26) (incluido X-Drive) (595300, 601200 excluido Kit M) (594300 incluido Kit M)	04/2014 - 05/2018	656300	Cisne		255,00	2400	12,00	100	B	766107	U	7	98,00	F	•	766113	U	13	120,00	G	•	747374	13	175,00	G	•	•	•	D	C	N				
X4 (G02) (incluido apertura maletero con pie)	06/2018 -	656300	Cisne		255,00	2500	12,50	100	B	766107	U	7	98,00	F	•	766113	U	13	120,00	G	•	747374	13	175,00	G	•	•	•	D	C	N				
X5 (E53) (excluido Kit M)	05/2000 - 12/2006	483500	Placa		400,00	3500	15,00	150	C	766107	U	7	98,00	F	•	766113	U	13	120,00	G	•	703244	13	170,00	H	•	•	•	C	E					
X5 (E70) (586800, excluido Kit M) (586900, incluido Kit M)	02/2007 - 06/2013	586800	Cisne		250,00	3500	16,00	150	C	766107	U	7	98,00	F	•	766113	U	13	120,00	G	•	703244	13	190,00	H	•	•	•	D	B	E				









Datos vehículo		Datos enganche									Datos kit eléctrico												
X5 (F15) (586800, excluido Kit M) (586900, incluido Kit M)	07/2013 - 08/2018	586800	Cisne		250,00	3500	16,00	150	C	766107	U	7	98,00	F	•								
		586900	BMU		485,00	3500	16,00	150	C	766113	U	13	120,00	G	•								
										703424		13	179,00	G	•	•	•	•	C	E			
X5 (G05) (incluido Kit M, Adblue, apertura maletero con pie)	09/2018 -	665600	Cisne		305,00	3500	16,00	140	C	766107	U	7	98,00	F	•								
		665700	BMU		515,00	3500	16,00	140	C	766113	U	13	120,00	G	•								
X6 (E71-E72) (incluido Kit M) (586900, incluido Kit M)	05/2008 - 07/2014	586900	BMU		485,00	•	3500	16,00	150	C	766107	U	7	98,00	F	•							
										766113	U	13	120,00	G	•								
										703344		13	185,00	H	•	•	•	D	B	E			
X6 (F16-F86) (incluido Kit M, apertura maletero con pie) (586900, incluido Kit M)	08/2014 - 07/2019	586900	BMU		485,00	•	3500	16,00	150	C	766107	U	7	98,00	F	•							
										766113	U	13	120,00	G	•								
										703424		13	179,00	G	•	•	•	•	C	E			
X7 (G7) (incluido Adblue, apertura maletero con pie)	03/2019 -	665600	Cisne		305,00	•	3500	16,00	140	C	766107	U	7	98,00	F	•							
		665700	BMU		515,00	•	3500	16,00	140	C	766113	U	13	120,00	G	•							

CHEVROLET

Aveo 3-5 puertas (T300)





































Aveo 3-5 puertas (T300)	03/2011 - 12/2016	546400	Cisne		209,00	•	1100	6,62	44	A	766107	U	7	98,00	F	•							
											766113	U	13	120,00	G	•							
											709574		13	180,00	G	•	•	•	•	R	Q		
Captiva	01/2006 - 12/2016	575600	Cisne		270,00	•	2000	11,50	80	B	766107	U	7	98,00	F	•							
		575700	BMA		440,00	•	2000	11,50	80	B	766113	U	13	120,00	G	•							
											735783	5	7	77,00	F	•					G	G	
											735784	5	13	95,00	F	•					C	E	

* Hasta finalización de stock

Datos vehículo		Datos enganche								Datos kit eléctrico							
 		       								          							
Cruze Berlina	05/2009 - 12/2016	548600	Cisne		224,00	1800	9,60	75	B	766107	U	7	98,00	F	•		
		520400	BMA		404,00	1800	9,60	75	B	766113	U	13	120,00	G	•		
Cruze 5 puertas	06/2011 - 12/2016	548600	Cisne		224,00	1800	9,60	75	B	766107	U	7	98,00	F	•		
		520400	BMA		404,00	1800	9,60	75	B	766113	U	13	120,00	G	•		
										709574		13	180,00	G	• • • • • B		
Cruze SW	08/2012 - 12/2016	566300	Cisne		250,00	1800	9,60	75	B	766107	U	7	98,00	F	•		
		566400	BMA		430,00	1800	9,60	75	B	766113	U	13	120,00	G	•		
Malibu	01/2012 - 12/2016	560800	BMA		405,00	1800	10,60	75	B	766107	U	7	98,00	F	•		
									766113	U	13	120,00	G	•			
										709574		13	180,00	G	• • • • • R Q		
Nubira Break	01/2005 - 12/2011	391100	Cisne		260,00	1200	7,20	75	B	766007	U	7	13,50	E			
									766113	U	13	39,50	F				
Orlando <small>(excluido GLP)</small>	02/2011 - 12/2016	542500	Cisne		215,00	1600	9,90	75	B	766107	U	7	98,00	F	•		
		542600	BMA		395,00	1600	9,90	75	B	766113	U	13	120,00	G	•		
										709574		13	180,00	G	• • • • • R Q		
Trax <small>(incluido 4WD)</small>	12/2012 - 12/2016	566500	Cisne		215,00	1200	7,50	75	B	766107	U	7	98,00	F	•		
		566600	BMA		395,00	1200	7,50	75	B	766113	U	13	120,00	G	•		
										709574		13	180,00	G	• • • • • R Q		

CHRYSLER



































300C Berlina <small>(excluido SRT8)</small>	09/2004 -	437900	BMA		580,00	2000	10,70	100	B	766107	U	7	98,00	F	•
										766113	U	13	120,00	G	•
300C Touring <small>(excluido SRT8)</small>	09/2004 -	437900	BMA		580,00	2000	10,70	100	B	766107	U	7	98,00	F	•
										766113	U	13	120,00	G	•
Grand Voyager (RG) <small>(incluido 4WD)(excluido Stow 'n Go)</small>	02/2000 - 12/2008	330200	Cisne		259,00	1600	9,90	80	C	766109	U	7	102,00	F	•
										766119	U	13	120,00	G	•
Grand Voyager (RT) <small>(incluido Stow 'n Go)</small>	01/2008 -	473000	Cisne		260,00	2000	11,50	200	B	766107	U	7	98,00	F	•
		473100	BMA		440,00	2000	11,50	200	B	766113	U	13	120,00	G	•
Voyager (RG) <small>(incluido 4WD) (excluido con sensor marcha atrás, Stow 'n Go)</small>	02/2000 - 12/2008	330200	Cisne		259,00	1600	9,90	80	C	766109	U	7	102,00	F	•
										766119	U	13	120,00	G	•

Datos vehículo		Datos enganche							Datos kit eléctrico								
				     							         						
CITROËN																	
Berlingo I (G****)	01/1996 - 09/2002	268600	Cisne		174,00 •	1100	7,00	70	A	766007	U 7	13,50 E					
		455600	BMC		354,00 ◦	1100	7,00	70	A	766013	U 13	39,50 F					
Berlingo I (G****)	10/2002 - 03/2008	268600	Cisne		174,00 •	1100	7,00	70	A	766107	U 7	98,00 F •					
		455600	BMC		354,00 ◦	1100	7,00	70	A	766113	U 13	120,00 G •					
										705314	13	175,00 F • • C E					
Berlingo I First (G****)	06/2008 - 12/2011	268600	Cisne		174,00 •	1100	7,00	70	A	766107	U 7	98,00 F •					
		455600	BMC		354,00 ◦	1100	7,00	70	A	766113	U 13	120,00 G •					
										705314	13	175,00 F • • C E					
Berlingo II (B9, 7) (versión corta) 410	04/2008 - 07/2018	505400	Cisne		195,00	1300	7,83	70	A	766107	U 7	98,00 F •					
		505600	Placa		209,00 ◦	1300	7,83	70	A	766113	U 13	120,00 G •					
		505500	BMAh		379,00 ◦	1300	7,83	70	A	705673	7	169,00 F • • D D G G					
										705674	13	179,00 H • • D D C E					
Berlingo III (K9,E) (no abre la doble puerta con el remolque enganchado)	08/2018 -	660200	Cisne		195,00	1450	8,70	74	A	766107	U 7	98,00 F •					
		660400	Placa		249,00	1450	8,70	74	A	766113	U 13	120,00 G •					
		660300	BMU		419,00	1450	8,70	74	A	738573	7	155,00 G • • D D G G					
		660401	Mixta		369,00	1450	8,70	74	A	738574	13	165,00 H • • D D C N					
Berlingo XL II (B9) (versión larga) (515500, 515600 algunos vehículos excluidos con sensor de marcha atrás) (excluido 4WD)	04/2008 - 07/2018	515500	Cisne		209,00	1600	8,70	70	A	766107	U 7	98,00 F •					
		515600	Placa		219,00	1600	8,70	70	A	766113	U 13	120,00 G •					
										705673	7	169,00 F • • D D G G					
										705674	13	179,00 H • • D D C E					
Berlingo XL III (K9,E) (versión larga) (no abre la doble puerta con el remolque enganchado)	08/2018 -	660500	Cisne		209,00	1450	8,70	74	A	766107	U 7	98,00 F •					
		660700	Placa		259,00	1450	8,70	74	A	766113	U 13	120,00 G •					
		660600	BMU		429,00	1450	8,70	74	A	738573	7	155,00 G • • D D G G					
		660701	Mixta		379,00	1450	8,70	74	A	738574	13	165,00 H • • D D C N					







































Datos vehículo		Datos enganche										Datos kit eléctrico																					
C2 I (JM)	09/2003 - 09/2005	374300	Cisne		199,00	600	4,20	27	A	766007	U	7	13,50	E	766013	U	13	39,50	F														
C2 II (JM)	09/2005 - 12/2009	374300	Cisne		199,00	600	4,20	27	A	766107	U	7	98,00	F	766113	U	13	120,00	G	•													
C3 I (FC) <small>(incluido X-TR)</small>	02/2002 - 09/2005	355000	Cisne		209,00	1100	6,60	50	A	766007	U	7	13,50	E	766013	U	13	39,50	F														
C3 I (FC) <small>(incluido X-TR)</small>	10/2005 - 10/2009	355000	Cisne		209,00	1100	6,60	50	A	766107	U	7	98,00	F	766113	U	13	120,00	G	•													
C3 II <small>(526600: excluido con sensor marcha atrás)</small>	11/2009 - 11/2016	526600	Cisne		185,00	1225	7,00	54	A	766107	U	7	98,00	F	766113	U	13	120,00	G	•													
										526700	BMAh		395,00	1225	7,00	54	A	766113	U	13	120,00	G	•										
																			705611		7	155,00	H	•	•	S	G	G					
C3 III (SX) <small>(556000: excluido con sensor marcha atrás)</small>	12/2016 -	556000	Cisne		188,00	1300	7,20	53	A	766107	U	7	98,00	F	766113	U	13	120,00	G	•													
										628500	BMU		418,00	1150	7,00	53	A	766113	U	13	120,00	G	•										
																			738544		13	175,00	G	•	•	◦	◦	B	E				
C3 Aircross <small>(649300, excluido con sensor marcha atrás)</small>	09/2017 -	649300	Cisne		230,00	870	7,10	55	A	766107	U	7	98,00	F	766113	U	13	120,00	G	•													
										650200	BMAh		370,00	870	7,10	50	A	766113	U	13	120,00	G	•										
																			735914		13	160,00	G	•	•	D	D	M	N				
C3 Picasso <small>(521200: excluido con sensor marcha atrás)</small>	02/2009 - 07/2017	521200	Cisne		188,00	1200	7,30	61	A	766107	U	7	98,00	F	766113	U	13	120,00	G	•													
										521300	BMAh		368,00	1200	7,30	61	A	766113	U	13	120,00	G	•										
																			705541		7	160,00	H	•	•		G	G					
C3 Pluriel	05/2003 - 07/2010	374000	Cisne		198,00	800	5,20	50	A	766107	U	7	98,00	F	766113	U	13	120,00	G	•													
C4 Aircross <small>(excluido 4WD)</small>	04/2012 -	681800	Cisne		219,00	1400	8,30	70	A	766107	U	7	98,00	F	766113	U	13	120,00	G	•													
										681900	BMA		419,00	1400	9,61	70	A	766113	U	13	120,00	G	•										
																			729494		13	135,00	H	•	•	S	M	N					























Datos vehículo		Datos enganche										Datos kit eléctrico																							
C4 I Coupé (LA) (excluido VTS 180)	11/2004 - 04/2011	417800	Cisne		215,00	○	1800	9,00	73	A	766107	U	7	98,00	F	•																			
		417900	BMA		395,00	●	1800	9,00	75	A	766113	U	13	120,00	G	•																			
												705573		7	175,00	H	•	•	•	D	G	G													
												705574		13	195,00	H	•	•	•	D	B	E													
C4 I 5 puertas (LC)	11/2004 - 07/2011	417800	Cisne		215,00	○	1800	9,00	73	A	766107	U	7	98,00	F	•																			
		417900	BMA		395,00	●	1800	9,00	75	A	766113	U	13	120,00	G	•																			
												705573		7	175,00	H	•	•	•	D	G	G													
												705574		13	195,00	H	•	•	•	D	B	E													
C4 II 5 puertas (B7)	11/2009 - 12/2019	538800	Cisne		209,00	○	1750	9,00	75	A	766107	U	7	98,00	F	•																			
		417900	BMA		395,00	●	1750	9,00	75	A	766113	U	13	120,00	G	•																			
												705573		7	-10/2010	175,00	H	•	•	•	D	G	G												
												705574		13	-10/2010	195,00	H	•	•	•	D	B	E												
												705643		7	11/2010-	165,00	H	•	•	D	D	G	G												
												705644		13	11/2010-	200,00	H	•	•	D	D	C	E												
C4 III 5 puertas	10/2020 -																																		
C4 Cactus	09/2014 - 03/2018	593300	Cisne		209,00		825	5,50	55	A	766107	U	7	98,00	F	•																			
		593400	BMA		389,00	•	825	5,50	55	A	766113	U	13	120,00	G	•																			
												738543		7	155,00	F	•	•	D	D	G	G													
C4 Cactus	04/2018 -	654600	Cisne		215,00		950	6,00	55	A	766107	U	7	98,00	F	•																			
		654700	BMA		395,00	•	950	6,00	55	A	766113	U	13	120,00	G	•																			
												735914		13	160,00	G	•	•	D	D	M	N													
C4 Picasso I (UD)	10/2006 - 01/2013	525400	Cisne		209,00		1700	9,00	100	A	766107	U	7	98,00	F	•																			
		525500	BMA		430,00	•	1700	9,00	100	A	766113	U	13	120,00	G	•																			
												705653		7	185,00	H	•	•	D	D	G	G													
												705654		13	215,00	H	•	•	D	D	B	E													
C4 Picasso II (DD) (incluido apertura maletero con pie)	02/2013 - 07/2018	546600	Cisne		209,00	○	1700	9,50	70	B	766107	U	7	98,00	F	•																			
		546700	BMCv		409,00	○	1700	9,50	70	B	766113	U	13	120,00	G	•																			
												705683		7	169,00	F	•	•	D	D	G	G													
												705684		13	179,00	G	•	•	D	D	C	E													

* Hasta finalización de stock





































Datos vehículo		Datos enganche										Datos kit eléctrico													
								€									€			CAN					
C-Crosser	02/2007 - 12/2012	530000	BMAh		455,00 •	2000	10,80	100	B	766107	U	7	98,00	F	•										
										766113	U	13	120,00	G	•										
										729432		13	135,00	F	•	•	•	B	E						
Evasion	06/1994 - 07/2002	316600	Cisne		184,00 ◦	1900	10,00	80	A	766007	U	7	13,50	E											
										766013	U	13	39,50	F											
Grand C4 Picasso I (UA)	10/2006 - 08/2013	525400	Cisne		199,00	1700	9,00	100	A	766107	U	7	98,00	F	•										
		525500	BMA		430,00 •	1700	9,00	100	A	766113	U	13	120,00	G	•										
										705653		7	185,00	H	•	•	D	D	G	G					
										705654		13	215,00	H	•	•	D	D	B	E					
Grand C4 Picasso II (DA,DE) <small>(incluido apertura maletero con pie)</small>	09/2013 - 07/2018	546600	Cisne		209,00 ◦	1700	9,50	70	B	766107	U	7	98,00	F	•										
		546700	BMCv		409,00 ◦	1700	9,50	70	B	766113	U	13	120,00	G	•										
										705683		7	169,00	F	•	•	D	D	G	G					
										705684		13	179,00	G	•	•	D	D	C	E					
Grand C4 SpaceTourer (3D) <small>(incluido apertura maletero con pie)</small>	08/2018 -	546600	Cisne		209,00 ◦	1700	9,50	70	B	766107	U	7	98,00	F	•										
		546700	BMCv		409,00 ◦	1700	9,50	70	B	766113	U	13	120,00	G	•										
										705683		7	169,00	F	•	•	D	D	G	G					
										705684		13	179,00	G	•	•	D	D	C	E					
Jumper I Furgón <small>(excluido 4WD)</small>	02/1994 - 03/2006	400300	Placa		360,00	2200	13,30	120	B	766008	U	7	15,00	E											
		400301	Mixta		480,00	2200	13,30	120	B	766013	U	13	39,50	F											
Jumper II Furgón <small>(incluido CNG)</small> <small>(excluido 4WD)</small>	04/2006 -	481900	Placa		260,00 ◦	3500	17,20	140	B	766107	U	7	98,00	F	•										
		481901	Mixta		380,00 ◦	3400	17,20	140	B	766113	U	13	120,00	G	•										
		441800	BMAh		619,00 ◦	3000	16,00	120	B	709331		7	-01/2011	175,00	H	•	•	G	G						
										709401		7	02/2011-	140,00	F	•	•	•	G	G					
Jumper I Chasis cabina <small>(excluido 4WD)</small>	02/1994 - 03/2006	400300	Placa		360,00	2200	13,30	120	B	766008	U	7	15,00	E											
		400301	Mixta		480,00	2200	13,30	120	B	766013	U	13	39,50	F											
Jumper II Chasis cabina <small>(excluido 4WD)</small> <small>(incluye ref. 9070819)</small>	04/2006 -	481902	Placa		325,00 ◦	3500	17,20	140	C	766107	U	7	98,00	F	•										
		481903	Mixta		445,00 ◦	3400	17,20	140	C	766113	U	13	120,00	G	•										

































* Hasta finalización de stock

Datos vehículo		Datos enganche								Datos kit eléctrico							
 		       								          							
Jumpy I	06/1994 - 12/2006	316600	Cisne		184,00	1900	10,00	80	A	766007	U 7	13,50	E				
										766013	U 13	39,50	F				
Jumpy II - III (excluido 4WD)	01/2007 - 03/2016	480900	Cisne		209,00	2000	12,20	122	B	766107	U 7	98,00	F •				
		504100	Placa		209,00	2000	12,20	122	B	766113	U 13	120,00	G •				
		481000	BMC		389,00	2000	12,20	122	B	705673	7	169,00	F • • D D G G				
									705674	13	179,00	H • • D D M G					
Jumpy IV (incluido versión compact, media, longue, apertura maletero con pie) (617400, 696600 y 696601: excluido con sensor marcha atrás) (excluido 4WD)	04/2016 -	617400	Cisne		229,00	2595	13,90	104	B	766107	U 7	98,00	F •				
		696600	Placa		259,00	2595	13,90	104	B	766113	U 13	120,00	F •				
		696601	Mixta		379,00	2595	13,90	104	B								
		617500	BMU		439,00	2595	13,90	104	B	738554	3 13	175,00	F • • D D C E				
Nemo (excluido con rueda recambio debajo coche)	02/2008 -	498000	Cisne		215,00	1300	7,50	75	B	766107	U 7	98,00	F •				
		498100	BMAh		395,00	1300	7,50	75	B	766113	U 13	120,00	G •				
										709371	7	160,00	G • G G				
Saxo	02/1996 - 04/2004	248800	Cisne		170,00	1100	6,10	50	A	766007	U 7	13,50	E				
										766013	U 13	39,50	F				
Space Tourer (incluido versión compact, media y longue) (617400, 696600 y 696601: excluido con sensor marcha atrás)	04/2016 -	617400	Cisne		229,00	2595	13,90	104	B	766107	U 7	98,00	F •				
		696600	Placa		259,00	2595	13,90	104	B	766113	U 13	120,00	F •				
		696601	Mixta		379,00	2595	13,90	104	B								
		617500	BMU		439,00	2595	13,90	104	B	738554	3 13	175,00	F • • D D C E				
Xsara 3-5 puertas	04/1997 - 04/2005	287300	Cisne		209,00	1300	7,30	80	A	766007	U 7	13,50	E				
										766013	U 13	39,50	F				
Xsara Picasso	01/2000 - 12/2011	434600	Cisne		209,00	1300	7,55	80	A	766007	U 7 -12/2007	13,50	E				
										766013	U 13 -12/2007	39,50	F				
										766107	U 7 01/2008-	98,00	F •				
										766113	U 13 01/2008-	120,00	G •				

Datos vehículo		Datos enganche								Datos kit eléctrico									
 		       								         									
CUPRA																			
Ateca	09/2016 -	623900	Cisne		209,00	2500	12,60	100	B	766107	U	7	98,00	F	•				
(incluido apertura maletero con pie)		666100	BMU		459,00	2500	12,60	100	B	766113	U	13	120,00	G	•				
										746304		13	185,00	H	• •	D	o	C	E

* Hasta finalización de stock

Datos vehículo		Datos enganche								Datos kit eléctrico									
 		       								         									
DACIA																			
Dokker (incluido GLP, si ha sido instalado en origen) (524100, excluido con sensor marcha atrás)	11/2012 -	524100	Cisne		199,00 °	1200	7,50	75	B	766107	U	7	98,00	F	•				
		560700	BMAh		419,00	1200	7,50	75	B	766113	U	13	120,00	G	•				
										742893		7	125,00	F	•	•	S	M	N
										742894		13	160,00	F	•	•	S	B	E
Dokker Stepway (incluido GLP, si ha sido instalado en origen) (524100, excluido con sensor marcha atrás)	11/2012 -	524100	Cisne		199,00 °	1200	7,50	75	B	766107	U	7	98,00	F	•				
		560700	BMAh		419,00	1200	7,50	75	B	766113	U	13	120,00	G	•				
										742893		7	125,00	F	•	•	S	G	
										742894		13	160,00	F	•	•	S	M	
Duster (incluido 4WD, Adblue y GLP)	04/2010 -	647600	Cisne		195,00	1500	8,85	75	A	766107	U	7	98,00	F	•				
		647800	Placa		255,00	1500	8,85	75	A	766113	U	13	120,00	G	•				
		647700	BMA		375,00	1500	8,85	75	A	742914		7	155,00	G	•	•	•	C	E
										743094		13	175,00	F	•	•	S	C	N
Lodgy (incluido Steepway)	03/2012 -	569800	Cisne		220,00	1450	8,10	75	A	766107	U	7	98,00	F	•				
		569900	BMA		400,00 °	1450	8,10	75	A	766113	U	13	120,00	G	•				
										743083		7	140,00	F	•	•	•	G	
										743084		13	155,00	F	•	•	•	M	
Logan 4 puertas	09/2004 - 09/2012	460200	Cisne		215,00	1100	6,40	75	A	766007	U	7	13,50	E					
										766013	U	13	39,50	F					
Logan 4 puertas	10/2012 -	577800	Cisne		199,00	1100	6,50	75	A	766107	U	7	98,00	F	•				
		577900	BMA		379,00 °	1100	6,50	75	A	766113	U	13	120,00	G	•				
Logan Pick-up	03/2008 -	486000	BMC		430,00	1300	7,59	75	A	766007	U	7	13,50	E					
										766013	U	13	39,50	F					
Logan MCV Break (excluido GLP)	02/2007 - 12/2012	485900	Cisne		245,00	1300	7,59	75	A	766007	U	7	13,50	E					
		486000	BMC		430,00	1300	7,59	75	A	766013	U	13	39,50	F					
Logan MCV Break (585700: excluido con sensor de marcha atrás)	01/2013 -	585700	Cisne		227,00 °	1300	8,00	75	A	766107	U	7	98,00	F	•				
		585800	BMA		417,00 °	1300	8,00	75	A	766113	U	13	120,00	G	•				
										742884		13	135,00	H	•	•	S	C	E

Datos vehículo		Datos enganche								Datos kit eléctrico																			
						€																							
Sandero I (excluido GLP)	06/2008 - 09/2012	506500	Cisne		194,00 •	1355	7,30	75	A	766007	U	7	13,50	E															
		506600	BMAh		374,00 •	1355	7,30	75	A	766013	U	13	39,50	F															
Sandero II (incluido GLP original)	10/2012 -	570700	Cisne		190,00 ◦	1100	7,30	75	A	766107	U	7	98,00	F •															
		570800	BMAh		370,00 •	1100	7,30	75	A	766113	U	13	120,00	G •															
											742853		7	-12/2016	121,00	G •													
										743043		7	01/2017 -	175,00	G •														
Sandero I Stepway (excluido GLP)	06/2008 - 09/2012	506500	Cisne		194,00 •	1355	7,30	75	A	766007	U	7	13,50	E															
		506600	BMAh		374,00 •	1355	7,30	75	A	766013	U	13	39,50	F															
Sandero II Stepway (incluido GLP original)	10/2012 -	570700	Cisne		190,00 •	1100	7,30	75	A	766107	U	7	98,00	F •															
		570800	BMAh		370,00 •	1100	7,30	75	A	766113	U	13	120,00	G •															
											742853		7	-12/2016	121,00	G •													
										743043		7	01/2017 -	175,00	G •														

* Hasta finalización de stock

Datos vehículo	Datos enganche	Datos kit eléctrico
----------------	----------------	---------------------

DAIHATSU

Materia (M4)	10/2006 -	494400	BMA		419,00	1400	7,30	60	B	766007	U	7	13,50	E
										766013	U	13	39,50	F
Sirion (M3)	01/2005 -	432300	BMC		389,00	1000	6,10	50	B	766007	U	7	13,50	E
										766013	U	13	39,50	F
Terios (J1) (excluido GLP)	05/1997 - 10/2006	268000	BMC		460,00	1400	7,30	60	B	766007	U	7	13,50	E
										766013	U	13	39,50	F
Terios (J2)	11/2005 -	458500	BMA		475,00	1350	7,60	55	B	766007	U	7	13,50	E
										766013	U	13	39,50	F









































DODGE

Caliber	06/2006 - 12/2012	452600	Cisne		219,00	1500	8,40	84	B	766107	U	7	98,00	F •
										766113	U	13	120,00	G •
										704504		13	190,00	G • • B E
Journey (547100 y 547200: excluido con rueda recambio debajo coche)	06/2008 -	547100	Cisne		205,00	1800	9,60	80	B	766107	U	7	98,00	F •
		547200 *	BMA		320,00	1600	9,60	80	B	766113	U	13	120,00	G •
		560500	BMA		425,00 ◦	1600	9,60	80	B	704504		13	190,00	G • • B E
Mini Ram Furgón (incluido Caravan, 4WD)	02/2000 - 12/2007	330200 *	Cisne		259,00 ◦	1600	9,90	80	B	766109	U	7	102,00	F •
										766119	U	13	120,00	G
Nitro	05/2006 - 12/2012	473200	Cisne		250,00 •	3500	15,20	350	B	766107	U	7	98,00	F •
		473300	BMA		430,00 •	3500	15,20	350	B	766113	U	13	120,00	G •







































Datos vehículo		Datos enganche							Datos kit eléctrico							
DS																
DS3 (526600: excluido con sensor marcha atrás) (excluido Cabrio)	04/2015 -	526600	Cisne		185,00 •	1225	7,00	54	A	766107	U	7	98,00	F	•	
		526700	BMA		395,00 •	1225	7,00	54	A	766113	U	13	120,00	G	•	
											705621		7	150,00	G	• • • G G
DS3 Crossback (Incluido Adblue y excluido E-Tense)	12/2018 -	678000	Cisne		255,00 •	1200	7,00	48	B	766107	U	7	98,00	F	•	
		678100	BMU		465,00 •	1200	7,00	48	B	766113	U	13	120,00	G	•	
											705764		13	165,00	G	• • ° ° C N
DS4 (incluido Crossback)	07/2015 -	538800	Cisne		209,00 °	1750	9,00	75	A	766107	U	7	98,00	F	•	
		417900	BMA		395,00 °	1800	9,00	75	A	766113	U	13	120,00	G	•	
											705643		7	165,00	H	• • D D G G
										705644		13	200,00	H	• • D D C E	
DS5 (excluido Hybrid, THP 200)	04/2015 -		BMA		389,00 •	1500	8,00	75	B	766107	U	7	98,00	F	•	
										766113	U	13	120,00	G	•	
											705643		7	165,00	H	• • D D G G
											705644		13	200,00	H	• • D D C E
DS7	02/2018 -	663600	Cisne		280,00 °	1850	10,20	80	A	766107	U	7	98,00	F	•	
		663700	BMA		410,00 °	1850	10,20	80	B	766113	U	13	120,00	G	•	
											705744		13	190,00	G	• • D D B G







































* Hasta finalización de stock

Datos vehículo		Datos enganche							Datos kit eléctrico						
FIAT															
500 (incluido TwinAir) (excluido Sport, Abarth, GLP)	10/2007 -	494200	Cisne		199,00	720	5,00	60	B	766107	U	7	98,00	F	•
		494300	BMA		379,00	720	5,00	60	B	766113	U	13	120,00	G	•
											709364		13	285,00	F
500 Cabrio (incluido TwinAir) (excluido Sport, Abarth, GLP)	09/2009 -	494200	Cisne		199,00	720	5,00	60	B	766107	U	7	98,00	F	•
		494300	BMA		379,00	720	5,00	60	B	766113	U	13	120,00	G	•
											709364		13	285,00	F
500L (incluido Living) (excluido Trekking)	09/2012 - 08/2017	591900	Cisne		225,00	1100	7,50	65	B	766107	U	7	98,00	F	•
		592000	BMA		410,00	1100	7,50	65	B	766113	U	13	120,00	G	•
											709514		13	250,00	H
500L (incluido Cross) (excluido Wagon, Natural Power) (644100, excluido con sensor aproximación trasero)	09/2017 -	644100	Cisne		225,00	1100	7,50	75	B	766107	U	7	98,00	F	•
		644200	BMA		405,00	1100	7,50	75	B	766113	U	13	120,00	G	•
											709514		13	250,00	H
500L Trekking	09/2012 - 08/2017	579800	BMA		415,00	1200	7,50	90	B	766107	U	7	98,00	F	•
										766113	U	13	120,00	G	•
											709514		13	250,00	H
500L Wagon	09/2017 -	645900	BMA		415,00	1100	7,50	75	B	766107	U	7	98,00	F	•
										766113	U	13	120,00	G	•
											709514		13	250,00	H
500X (incluido Adblue, Cross, 4WD, City Look, Off-road Look) (excluido City Cross, Sport)	09/2014 -	643600	Cisne		259,00	1500	10,50	75	B	766107	U	7	98,00	F	•
		599500 *	BMA		339,00	1500	9,50	75	B	766113	U	13	120,00	G	•
		605000	BMU		449,00	1500	10,50	100	B	719674		13	180,00	G	• • • S B E
Bravo II (incluido GLP)	11/2006 - 12/2014	510200	Cisne		209,00	1300	7,70	90	B	766107	U	7	98,00	F	•
		484200	BMA		389,00	1300	7,70	60	B	766113	U	13	120,00	G	•
Doblo (119,223) (incluido Maxi) (348600: no permite abrir el portón con el remolque colocado) (348600: excluido con sensor de marcha atrás)	11/2000 - 12/2009	348600	Cisne		229,00	1300	8,33	60	B	766107	U	7	98,00	F	•
										766113	U	13	120,00	G	•
Doblo (263) (incluido Maxi, Trekking) (excluido work up, Natural Power, CNG)	01/2010 -	526300	Cisne		209,00	1500	9,00	60	B	766107	U	7	98,00	F	•
		526400	BMA		389,00	1500	9,00	60	B	766113	U	13	120,00	G	•
											709524		13	200,00	G























Datos vehículo		Datos enganche								Datos kit eléctrico										
 		        								          										
Doblo (263) (incluido Maxi) (sólo Natural Power, CNG)	01/2010 -	541200	BMA		419,00 •	1000	7,00	60	B	766107	U	7	98,00	F	•					
										766113	U	13	120,00	G	•					
										709524		13	200,00	G	•	•	•	G	N	
Ducato I Furgón (excluido 4WD)	03/1994 - 06/2006	400300	Placa		360,00	2200	13,30	120	B	766008	U	7	15,00	E						
		400301	Mixta		480,00	2200	13,30	120	B	766013	U	13	39,50	F						
Ducato II Furgón (incluido CNG) (excluido 4WD)	07/2006 -	481900	Placa		260,00 ◦	3500	17,20	140	B	766107	U	7	98,00	F	•					
		481901	Mixta		380,00 ◦	3400	17,20	140	B	766113	U	13	120,00	G	•					
		441800	BMAh		619,00 ◦	3000	16,00	120	B	709331		7	-01/2011	175,00	H	•	•		G	G
									709401		7	02/2011-	140,00	F	•	•	•	G	G	
Ducato I Chasis cabina (excluido 4WD)	03/1994 - 06/2006	400300	Placa		360,00	2200	13,30	120	B	766008	U	7	15,00	E						
		400301	Mixta		480,00	2200	13,30	120	B	766013	U	13	39,50	F						
Ducato II Chasis cabina (incluido CNG) (excluido 4WD) (incluye ref. 9070819)	07/2006 -	481902	Placa		325,00 ◦	3500	17,20	140	C	766107	U	7	98,00	F	•					
		481903	Mixta		445,00 ◦	3400	17,20	140	C	766113	U	13	120,00	G	•					
										709533		13	215,00	G	•	•	•	G	G	
Fiorino (excluido Versión "Natural Power") (excluido con rueda recambio debajo coche)	11/2007 -	498000	Cisne		215,00	1300	7,50	75	B	766107	U	7	98,00	F	•					
		498100	BMAh		395,00 •	1300	7,50	75	B	766113	U	13	120,00	G	•					
										709371		7	160,00	G	•			G	G	
Freemont (incluido 4WD, Cross) (547100: excluido con rueda de recambio debajo coche)	08/2011 -	547100	Cisne		205,00	1600	9,60	80	B	766107	U	7	98,00	F	•					
		560500	BMA		425,00 ◦	1600	9,60	80	B	766113	U	13	120,00	G	•					
										704504		13	-07/2012	190,00	G	•	•	B	E	
									709504		13	08/2012-	220,00	G	•	•	S	C	E	
Fullback Pickup (incluido 4WD, Cross) (solamente válido para vehículos con paragolpes tipo escalón)	01/2016 -	604400	Placa		309,00	3100	14,80	125	A	766107	U	7	98,00	F	•					
		604401	Mixta		429,00	3100	14,80	125	A	766113	U	13	120,00	G	•					
										729544		13	210,00	F	•	•		B	E	
Grande Punto (excluido Abarth, Natural Power)	11/2005 - 12/2011	525600	Cisne		195,00 ◦	1100	6,70	60	B	766107	U	7	98,00	F	•					
		525700	BMA		375,00 ◦	1100	6,70	60	B	766113	U	13	120,00	G	•					
Idea	12/2003 - 12/2012	509500	Cisne		219,00 ◦	1200	6,80	80	B	766107	U	7	98,00	F	•					
										766113	U	13	120,00	G	•					









































* Hasta finalización de stock

Datos vehículo		Datos enganche								Datos kit eléctrico										
 		       								          										
Multipla	04/1999 - 12/2007	320500	Cisne		255,00 •	1300	8,33	70	B	766007	U	7	13,50	E						
										766013	U	13	39,50	F						
Panda (2WD) (169) (excluido 4WD, Natural Power, 110HP)	09/2003 - 01/2012	383700	Cisne		205,00	800	5,83	60	B	766107	U	7	98,00	F	•					
		383800	BMA		415,00 •	800	5,83	60	B	766113	U	13	120,00	G	•					
										709284		13	244,00	G	•	•			B	E
Panda (2WD) (312) (excluido 4WD, Trekking, Cross, City Cross, Natural Power) (excluido 1.2L, 69CV Euro 6D)	02/2012 -	548200	Cisne		200,00 °	1000	6,10	60	B	766107	U	7	98,00	F	•					
		547900	BMA		380,00 °	1000	6,10	60	B	766113	U	13	120,00	G	•					
										709464		13	170,00	H	•	•	•		B	E
Panda (4WD) (169)	09/2003 - 01/2012	429500	Cisne		199,00 •	800	6,16	60	B	766107	U	7	98,00	F	•					
										766113	U	13	120,00	G	•					
										709284		13	244,00	G	•	•			B	E
Panda (4WD) (312) (incluido Cross, Trekking) (excluido Van, CNG, Natural Power, City Cross)	02/2012 -	649100	Cisne		225,00 °	1000	5,80	60	B	766107	U	7	98,00	F	•					
		649200	BMA		405,00 °	1000	5,80	60	B	766113	U	13	120,00	G	•					
										709464		13	170,00	H	•	•	•		B	E
Punto (176) (Incluido Van, Cabrio)	09/1993 - 09/1999	232400	Cisne		185,00 •	1300	6,80	70	B	766107	U	7	98,00	F	•					
										766113	U	13	120,00	G	•					
Punto (188) (incluido Van) (excluido versión "Natural Power")	02/2003 - 12/2010	360700	BMC		400,00 •	1100	7,16	60	B	766107	U	7	98,00	F	•					
										766113	U	13	120,00	G	•					
Punto (199) (incluido Pop - Easy - Lounge, Van) (excluido Abarth, Natural Power)	03/2012 -	525600	Cisne		195,00 °	1100	6,70	60	B	766107	U	7	98,00	F	•					
		525700	BMA		375,00 °	1100	6,70	60	B	766113	U	13	120,00	G	•					
Punto Evo (199) (incluido Van) (excluido versión "Natural Power")	07/2008 - 10/2011	525600	Cisne		195,00 •	1100	6,70	60	B	766107	U	7	98,00	F	•					
		525700	BMA		375,00 •	1100	6,70	60	B	766113	U	13	120,00	G	•					
Qubo (excluido versión "Natural Power" / Trekking) (excluido con rueda recambio debajo coche)	02/2008 -	498000	Cisne		215,00	1300	7,50	75	B	766107	U	7	98,00	F	•					
		498100	BMAh		395,00 •	1300	7,50	75	B	766113	U	13	120,00	G	•					
										709371		7	160,00	G	•				G	G
Scudo I (220)	02/1996 - 12/2006	316600	Cisne		184,00 °	1900	10,00	80	A	766007	U	7	13,50	E						
										766013	U	13	39,50	F						











































Datos vehículo		Datos enganche										Datos kit eléctrico																													
																																									
Scudo II (270) (excluido 4WD)	01/2007 - 03/2016	480900	Cisne		209,00	2000	12,20	122	B	766107	U	7	98,00	F	•																										
		504100	Placa		209,00	2000	12,20	122	B	766113	U	13	120,00	G	•																										
		481000	BMC		389,00	2000	12,20	122	B	705673		7	169,00	F	•	•	D	D	G	G																					
		705674										13	179,00	H	•	•	D	D	M	G																					
Sedici (incluido 4WD)	06/2006 -	469700	Cisne		207,00	1200	7,10	50	C	766007	U	7	13,50	E																											
		469800	BMAh		397,00	1200	7,10	50	C	766013	U	13	39,50	F																											
		751292										13	75,00	F																											
Stilo Multi Wagon (excluido Uproad)	01/2003 - 08/2008	376600	Cisne		245,00	1300	8,00	60	B	766107	U	7	98,00	F	•																										
		766113										13	120,00	G	•																										
Talento	06/2016 -	595500	Placa		232,00	2000	12,10	80	B	766107	U	7	98,00	F	•																										
		595501	Mixta		352,00	2000	12,10	80	B	766113	U	13	120,00	G	•																										
		573000	BMC		502,00	2000	12,10	80	B	742933		7	160,00	F	•																										
		742934									13	185,00	F	•																											
Tipo 4 puertas	10/2015 -	624900	Cisne		258,00	1700	9,00	70	B	766107	U	7	98,00	F	•																										
		618400 *	BMA		328,00	1200	7,50	60	B	766113	U	13	120,00	G	•																										
		625000	BMU		468,00	1700	9,00	70	B																																
Tipo 5 puertas	03/2016 -	624900	Cisne		258,00	1700	9,00	70	B	766107	U	7	98,00	F	•																										
		625000	BMU		468,00	1700	9,00	70	B	766113	U	13	120,00	G	•																										
Tipo Station Wagon	03/2016 -	624900	Cisne		258,00	1700	9,00	70	B	766107	U	7	98,00	F	•																										
		625000	BMU		468,00	1700	9,00	70	B	766113	U	13	120,00	G	•																										
Ulysse I (220)	06/1994 - 08/2002	316600	Cisne		184,00	1900	10,00	80	A	766007	U	7	13,50	E																											
		766013										13	39,50	F																											
Ulysse II (179)	08/2002 - 06/2011	365600	Cisne		245,00	1900	11,30	76	A	766107	U	7	98,00	F	•																										
		365700 *	BMC		425,00	1900	11,30	76	A	766113	U	13	120,00	G	•																										
		705604										13	220,00	H	•	•	•	D	B	E																					

* Hasta finalización de stock

Datos vehículo		Datos enganche								Datos kit eléctrico							
																	
FORD																	
B-MAX		10/2012 -	562700	Cisne		240,00	750	7,00	50	A	766107	U	7	98,00	F	•	
(comprobar MMR)			562800	BMA		420,00	750	7,00	50	A	766113	U	13	120,00	G	•	
(excluido vehículos con Gas)											712103		7	175,00	G	• • G G	
C-MAX (DM2)		02/2007 - 11/2010	538600	Cisne		169,00	1800	10,00	75	A	766107	U	7	98,00	F	•	
(incluido GLP)			538700	BMA		349,00	1800	10,00	75	A	766113	U	13	120,00	G	•	
C-MAX II (BJ/BV)		12/2010 -	538600	Cisne		169,00	1800	10,00	75	A	766107	U	7	98,00	F	•	
(excluido GLP, Plug-in-Hybrid)			538700	BMA		349,00	1800	10,00	75	A	766113	U	13	120,00	G	•	
											712053		7	170,00	H	• • ° D G G	
											712054		13	185,00	H	• • ° D B E	
Ecosport		08/2018 -	657900	Cisne		230,00	1100	7,00	75	A	766107	U	7	98,00	F	•	
(incluido ST-Line)			658000	BMA		410,00	1100	7,00	75	A	766113	U	13	120,00	G	•	
(excluido 4WD)																	
Edge		06/2016 -	629900	Cisne		250,00	2350	12,00	90	B	766107	U	7	98,00	F	•	
(incluido Adblue, Sport, Vignale)			630000	BMU		500,00	2350	12,00	90	B	766113	U	13	120,00	G	•	
(excluido USA)																	
Fiesta V 3-5 puertas (JH1)		11/2001 - 06/2008	345600	Cisne		215,00	1050	6,50	50	A	766007	U	7	13,50	E		
(excluido ST)			345700	BMC		395,00	1050	6,50	50	A	766013	U	13	39,50	F		
Fiesta VI 3-5 puertas (JR)		06/2008 - 07/2017	506300	Cisne		185,00	900	5,70	50	A	766107	U	7	98,00	F	•	
(excluido 1.6 Duratorq TDCI, 1,4 Duratec LPG)			506400	BMAh		355,00	900	5,70	50	A	766113	U	13	120,00	G	•	
(excluido Titanium, Sport, Zetec S, ECONetic)			628600	BMU		425,00	900	5,70	50	A							
(506300, 506400: excluido ST-Line)																	
(628600, incluido ST-Line)																	
Fiesta VII 3-5 puertas		08/2017 -	640400	Cisne		199,00	1000	6,20	65	A	766107	U	7	98,00	F	•	
(incluido Titanium, Active)			640500	BMU		429,00	1000	6,20	65	A	766113	U	13	120,00	G	•	
(excluido ST Line)																	
Focus I 3-5 puertas (DAW,DBW)		10/1998 - 10/2004	328000	Cisne		173,00	1400	7,80	75	A	766007	U	7	13,50	E		
											766013	U	13	39,50	F		
Focus II 3-5 puertas (DA)		11/2004 - 03/2011	538600	Cisne		169,00	1800	10,00	75	A	766107	U	7	98,00	F	•	
(excluido ST, ECONetic, RS, Cabrio, Latvala, Hyroven)			538700	BMA		349,00	1800	10,00	75	A	766113	U	13	120,00	G	•	

Datos vehículo		Datos enganche									Datos kit eléctrico										
 		       									         										
Focus III 5 puertas (DY) (excluido Pack Styling, ST)	04/2011 - 08/2018	538600	Cisne		169,00	◦	1800	10,00	75	A	766107	U	7	98,00	F	•					
		538700	BMA		349,00	◦	1800	10,00	75	A	766113	U	13	120,00	G	•					
											712053		7	170,00	H	• • ◦ D G G					
																	712054	13	185,00	H	• • ◦ D B E
Focus IV 5 puertas (HN) (incluido ST-Line, Active) (excluido ST)	09/2018 -	655300	Cisne		230,00	◦	1800	9,40	90	A	766107	U	7	98,00	F	•					
		655400	BMA		410,00	◦	1800	9,40	90	A	766113	U	13	120,00	G	•					
																	712324	13	175,00	G	• • ◦ D C N
Focus II Berlina (DA)	04/2005 - 04/2011	544500	Cisne		195,00	•	1500	10,00	75	B	766107	U	7	98,00	F	•					
											766113	U	13	120,00	G	•					
Focus III Berlina (DY) (excluido pack Styling)	04/2011 - 08/2018	544500	Cisne		195,00	•	1500	10,00	75	A	766107	U	7	98,00	F	•					
		544600 *	BMA		355,00	◦	1500	10,00	75	A	766113	U	13	120,00	G	•					
											712053		7	170,00	H	• • ◦ D G G					
																	712054	13	185,00	H	• • ◦ D B E
Focus I Break (DNW) (excluido paragolpes RS)	02/1999 - 04/2005	428100	Cisne		219,00	◦	1300	7,70	75	B	766007	U	7	13,50	E						
											766013	U	13	39,50	F						
Focus II Break (DA) (excluido ST, ECONetic)	11/2004 - 09/2012	448100	Cisne		250,00		1500	8,50	75	A	766107	U	7	98,00	F	•					
		448200	BMC		430,00	◦	1500	8,50	75	A	766113	U	13	120,00	G	•					
Focus III Break (DY) (incluido ECONetic) (excluido ST-Line, ST)	05/2011 - 08/2018	546100	Cisne		225,00	◦	1500	10,00	75	A	766107	U	7	98,00	F	•					
		546200	BMA		405,00	◦	1500	10,00	75	A	766113	U	13	120,00	G	•					
											712053		7	170,00	H	• • ◦ D G G					
																	712054	13	185,00	H	• • ◦ D B E
Focus IV Break (HP) (incluido ST-Line) (excluido apertura maletero con pie) (661500, 661600: excluido Active) (676700, incluido ST-Line, Active)	09/2018 -	661500	Cisne		229,00	◦	1500	10,00	90	B	766107	U	7	98,00	F	•					
		661600	BMA		409,00	◦	1500	10,00	90	B	766113	U	13	120,00	G	•					
		676700	BMU			◦	1500	10,00	90	B	712324		13	175,00	G	• • ◦ D C N					
Focus C-MAX (DM) (incluido GLP)	10/2003 - 03/2007	538600	Cisne		169,00	◦	1800	10,00	75	A	766107	U	7	98,00	F	•					
		538700	BMA		349,00	◦	1800	10,00	75	A	766113	U	13	120,00	G	•					
		679800	BMU								711581		7	85,00	G	• • G G					
Fusión (JU1) (excluido con sensor marcha atrás)	8/2002 - 12/2012	345600	Cisne		215,00	◦	1050	6,50	50	A	766007	U	7	13,50	E						
		345700	BMC		395,00	◦	1050	6,50	50	A	766013	U	13	39,50	F						
Galaxy (WGR) (excluido con sensor marcha atrás)	03/1995 - 04/2000	270200	Cisne		235,00	•	2100	11,20	85	B	766007	U	7	13,50	E						
											766013	U	13	39,50	F						















* Hasta finalización de stock

Datos vehículo		Datos enganche								Datos kit eléctrico							
 		       								          							
Galaxy (WGR)	05/2000 - 05/2006	350000	Cisne		235,00	•	2100	11,20	85	B	766007	U	7	13,50	F	•	
		468300	BMA		415,00	◦	2100	11,20	85	B	766113	U	13	120,00	G	•	
Galaxy (WA6) (7 plazas) (sin regulador de nivel)	05/2006 - 06/2015	478200	Cisne		205,00	◦	2000	12,10	80	A	766107	U	7	98,00	F	•	
		478300	BMA		430,00	•	2000	12,10	80	A	766113	U	13	120,00	G	•	
Galaxy (WA6)(7TCL) (incluido apertura maletero con pie) (excluido con rueda repuesto)	06/2015 -	608900	Cisne		209,00	◦	2100	12,00	85	B	766107	U	7	98,00	F	•	
		609000	BMU		449,00	◦	2100	12,00	85	B	766113	U	13	120,00	G	•	
Grand C-MAX	12/2010 -	538600	Cisne		169,00	◦	1800	10,00	75	A	766107	U	7	98,00	F	•	
		538700	BMA		349,00	◦	1800	10,00	75	A	766113	U	13	120,00	G	•	
											712053		7	170,00	H	• • ◦ D G G	
											712054		13	185,00	H	• • ◦ D B E	
Grand Tourneo Connect (excluido ECONetic)	09/2013 -	585900	Cisne		199,00		1200	8,00	75	A	766107	U	7	98,00	F	•	
		586100	Placa		239,00		1200	8,00	75	A	766113	U	13	120,00	G	•	
		586000	BMAh		379,00		1200	8,00	75	A	712164		13	-04/2018	240,00	G	• • ◦ D ◦ C E
											712324		13	05/2018-	175,00	G	• • ◦ D C N
Kuga I (incluido 4WD)	03/2008 - 02/2013	505900	Cisne		235,00	◦	2100	10,50	105	B	766107	U	7	98,00	F	•	
		506000	BMAh		415,00	•	2100	10,50	105	B	766113	U	13	120,00	G	•	
		506200	MX		915,00	•	2100	10,50	105	B	711991		7	108,00	G	• • • G G	
											711994		13	168,00	G	• • • B D	
Kuga II (DM2) (574900: incluido ST-Line desde 01/2017-) (574900 y 632100: incluido apertura maletero con pie) (632100: incluido 4WD, ST-Line, Sport, Titanium, Vignale)	03/2013 - 12/2019	574900	Cisne		240,00		2100	10,70	105	B	766107	U	7	98,00	F	•	
		632100	BMU		460,00		2100	10,70	105	B	766113	U	13	120,00	G	•	
											712054		13	185,00	H	• • ◦ D B E	
Kuga III (incluido 4WD)	11/2019 -	679600	Cisne		280,00		1900	11,25	100	B	766107	U	7	98,00	F	•	
		679700	BMU		460,00		1900	11,25	100	B	766113	U	13	120,00	G	•	
		681100	MX														
Maverick	02/1993 - 12/1998	310000	Cisne		173,00		3000	13,60	120	A	766007	U	7	13,50	E		
											766013	U	13	39,50	F		
Maverick (1EZ/1N2)	02/2001 - 03/2004	386200	Cisne		309,00	•	2000	10,00	80	A	766007	U	7	13,50	E		
											766013	U	13	39,50	F		
Mondeo III Berlina (B4V) (excluido RS, ST220, 4WD)	10/2000 - 03/2007	384800	Cisne		225,00	•	2000	11,00	80	B	766107	U	7	98,00	F	•	
											766113	U	13	120,00	G	•	
											711462		13	165,00	H	• • • B D	





















Datos vehículo		Datos enganche								Datos kit eléctrico							
Mondeo IV Berlina (BD) (486400: incluido ST)	03/2007 - 08/2014	486300	Cisne		205,00 ^o	2120	11,60	80	A	766107	U	7	98,00	F	•		
		486400	BMA		395,00 ^o	2120	11,60	80	A	766113	U	13	120,00	G	•		
Mondeo III 5 puertas (B5Y) (excluido RS, ST220, 4WD)	10/2000 - 03/2007	384800	Cisne		225,00 [•]	2000	11,00	80	B	766107	U	7	98,00	F	•		
										766113	U	13	120,00	G	•		
Mondeo IV 5 puertas (BE)	03/2007 - 08/2014	488600	Cisne		205,00 ^o	2120	11,60	80	A	766107	U	7	98,00	F	•		
		488700	BMAh		395,00 ^o	2120	11,60	80	A	766113	U	13	120,00	G	•		
Mondeo V 5 puertas (DYK) (600900, incluido Vignale, excluido ST-Line) (601000 excluido Vignale, ST-Line)	09/2014 -	600900	Cisne		220,00 ^o	2500	11,90	100	B	766107	U	7	98,00	F	•		
		601000	BMA		400,00 ^o	2500	11,90	100	B	766113	U	13	120,00	G	•		
Mondeo III Break (BWY) (excluido RS / ST220 / 4WD)	10/2000 - 03/2007	385200	Cisne		240,00 [•]	2000	11,00	80	A	766107	U	7	98,00	F	•		
										766113	U	13	120,00	G	•		
Mondeo IV Break (BG)	03/2007 - 10/2014	486300	Cisne		205,00 ^o	2120	11,60	80	A	766107	U	7	98,00	F	•		
		486400	BMA		395,00 [•]	2120	11,60	80	A	766113	U	13	120,00	G	•		
Mondeo V Sport Break (DYL) (600900, incluido Vignale, excluido ST-Line) (601000 excluido Vignale, ST-Line)	11/2014 -	600900	Cisne		220,00 ^o	2500	11,90	100	B	766107	U	7	98,00	F	•		
		601000	BMA		400,00 ^o	2500	11,90	100	B	766113	U	13	120,00	G	•		
Puma	09/2019 -	685000	Cisne		240,00	1200	7,40	75	B	766107	U	7	98,00	F	•		
		685100	BMU		450,00	1200	7,40	75	B	766113	U	13	120,00	G	•		
Ranger (con barra rectangular, si lleva tubos se eliminan) (incluido 4WD) (excluido vehículos con paragolpes escalón)	11/1998 - 03/2011	482600	Placa		335,00	3000	15,00	125	A	766007	U	7	13,50	E			
		482601	Mixta		455,00	3000	15,00	125	A	766013	U	13	39,50	F			
Ranger (TKE) (vehículos con barra antiempotramiento) (incluido Adblue, 4WD, XL) (excluido M-Sport)	04/2011 -	557400	Placa		509,00	3500	17,20	225	A	766107	U	7	98,00	F	•		
		557401	Mixta		629,00	3400	17,20	225	A	766113	U	13	120,00	G	•		
									712064		13	-9/2015	250,00	F	• • • D B E		
									712214	3	13	10/2015-	215,00	F	• • ◦ ◦ G G		

* Hasta finalización de stock

















Datos vehículo		Datos enganche						Datos kit eléctrico					
HONDA													
Accord VIII 4 puertas (CU) <small>(excluido S-Type)</small>	06/2008 - 05/2015	505700	Cisne		240,00 •	1700	9,10	75	B	766107	U 7	98,00	F •
		505800	BMAh		390,00 •	1700	9,10	75	B	766113	U 13	120,00	G •
Accord VII Tourer (CM)	01/2003 - 05/2008	460700	Cisne		245,00 ◦	1500	8,50	75	B	766107	U 7	98,00	F •
										766113	U 13	120,00	G •
Accord VIII Tourer (CW) <small>(excluido S-Type)</small>	06/2008 - 05/2015	505700	Cisne		240,00 •	1700	9,10	75	B	766107	U 7	98,00	F •
		505800	BMAh		390,00 •	1700	9,10	75	B	766113	U 13	120,00	G •
Civic VII 5 puertas (EU,EP,EV)	03/1999 - 02/2006	367300	Cisne		255,00 ◦	1200	6,90	50	B	766107	U 7	98,00	F •
										766113	U 13	120,00	G •
Civic VIII 5 puertas (FN,FK)	09/2005 - 12/2011	425700	Cisne		240,00 •	1700	8,00	75	B	766107	U 7	98,00	F •
		425800	BMC		350,00 •	1700	8,00	75	B	766113	U 13	120,00	G •
Civic IX 5 puertas (FK) <small>(excluido X-Edition)</small>	02/2012 - 04/2017	558000	Cisne		220,00 ◦	1700	8,00	75	B	766107	U 7	98,00	F •
		558100	BMA		500,00 ◦	1700	8,00	75	B	766113	U 13	120,00	G •
Civic IX Tourer (FK)	01/2014 -	588700	Cisne		214,00 •	1400	9,90	75	B	766107	U 7	98,00	F •
										766113	U 13	120,00	G •
										714534	13	160,00	G • • • C E
CR-V II (RD 8/9)	03/2002 - 09/2006	401700	Placa		300,00	1500	8,00	100	B	766007	U 7	13,50	E
		401701	Mixta		420,00	1500	8,00	100	B	766013	U 13	39,50	F
		401600	BMC		450,00	1500	8,00	100	B				
CR-V III (RE)	06/2006 - 10/2012	487000	Cisne		280,00 ◦	2000	10,43	100	B	766107	U 7	98,00	F •
		487100	BMC		450,00 ◦	2000	10,43	100	B	766113	U 13	120,00	G •
CR-V IV (RE/RM) <small>(excluido Black edition)</small>	11/2012 - 10/2018	603300	Cisne		230,00 ◦	2000	12,00	100	B	766107	U 7	98,00	F •
		603400	BMA		415,00	2000	12,00	100	B	766113	U 13	120,00	G • •
										714514	13	190,00	H • • S B E

































Datos vehículo		Datos enganche							Datos kit eléctrico							
																
																
CR-V V (RW) (incluido Hybrid)	11/2018 -	684100	Cisne						766107	U	7	98,00	F	•		
		684200	BMA						766113	U	13	120,00	G	• •		
FR-V (BE) (excluido 2.2L)	08/2004 - 12/2009	446900	Cisne		290,00	◦	1500	8,40	90	B	766007	U	7	13,50	E	
HR-V (RU)	01/2015 -	619300	Cisne		225,00	◦	1400	7,19	70	B	766107	U	7	98,00	F	•
		619400	BMAh		405,00	◦	1400	7,19	70	B	766113	U	13	120,00	G	• •
Jazz II (GD)	03/2002 - 12/2008	381600	Cisne		235,00	•	1000	5,90	70	B	766007	U	7	13,50	E	
Jazz III (GE/GG) (excluido S(i) , Hybrid)	07/2008 - 08/2014	513500	Cisne		195,00	◦	1000	6,10	95	B	766007	U	7	13,50	A	
Jazz IV (GP/GF/GK) (excluido Dynamic)	09/2015 -	610400	Cisne		220,00	•	1000	6,11	95	B	766007	U	7	13,50	A	
		610500	BMAh		400,00	◦	1000	6,11	95	B	766013	U	13	39,50	F	

* Hasta finalización de stock











































Datos vehículo	Datos enganche	Datos kit eléctrico
 	      	          





















HYUNDAI

Atos (MX)	02/1998 - 12/1999	403200	Cisne 	200,00	700 4,00 28 A	766007 U 7	13,50 E	
						766013 U 13	39,50 F	
Atos Prime (MX)	02/1998 - 08/2008	403200	Cisne 	200,00	700 4,00 28 A	766007 U 7	13,50 E	
						766013 U 13	39,50 F	
Getz (TB)	08/2002 - 08/2005	402000	Cisne 	190,00 ◦	1100 6,50 44 A	766007 U 7	13,50 E	
						766013 U 13	39,50 F	
Getz (TB)	09/2005 - 06/2009	458300	BMC 	360,00 ◦	1100 6,50 44 A	766007 U 7	13,50 E	
						766013 U 13	39,50 F	
Grand Santa Fe (DM) (incluido 4WD)	06/2013 -	564200	Cisne 	249,00 *	2500 12,60 100 B	766107 U 7	98,00 F •	
		564300	BMA 	429,00 *	2500 12,60 100 B	766113 U 13	120,00 G •	
		590600	BMU 	469,00 ◦	2500 12,60 100 B	716674	13 205,00 G •	• S B E
H-1 Furgón (chasis corto, largo) (excluido 4WD)	10/1997 - 12/2007	396300	Cisne 	250,00 ◦	1800 11,20 75 B	766007 U 7	13,50 E	
						766013 U 13	39,50 G	
H-1 Cargo (TQ) (incluido Travel) (excluido 4WD)	02/2008 -	516100	Cisne 	309,00 ◦	2400 14,01 100 B	766007 U 7	13,50 E	
						766013 U 13	39,50 F	
						716584	13 215,00 F	• • B E
H-200 Furgón (2WD) (chasis corto, largo)	06/1997 - 09/2007	396300	Cisne 	250,00 ◦	1800 11,20 75 B	766007 U 7	13,50 E	
						766013 U 13	39,50 F	
H-300 (TQ)	02/2008 -	516100	Cisne 	309,00 ◦	2400 14,01 100 B	766007 U 7	13,50 E	
						766013 U 13	39,50 F	
i10 (PA)	10/2007 - 11/2013	491100	BMAh 	359,00 •	900 5,50 32 A	766007 U 7	13,50 E	
						766013 U 13	39,50 F	
i20 3-5 puertas (PB,PBT)	08/2008 - 11/2014	508200	BMA 	379,00 •	1100 6,50 50 A	766107 U 7	98,00 F •	
						766113 U 13	120,00 G •	
i20 5 puertas (GB) (incluido Active) (excluido vehículos con Gas)	11/2014 -	596200	Cisne 	189,00 •	1200 7,00 75 A	766107 U 7	98,00 F •	
		596300	BMAh 	369,00 •	1200 7,00 75 A	766113 U 13	120,00 G •	
i30 5 puertas (FD)	10/2007 - 04/2010	519100	BMA 	384,00 ◦	1500 8,50 75 B	766107 U 7	98,00 F •	
						766113 U 13	120,00 G •	
i30 5 puertas (FD)	05/2010 - 11/2011	534400	BMA 	385,00 ◦	1500 8,50 75 B	766107 U 7	98,00 F •	
						766113 U 13	120,00 G •	





Datos vehículo		Datos enganche									Datos kit eléctrico								
																			
																			
																			
i30 3-5 puertas (GD) <small>(de 09/2015- , excluido 3 puertas con Turbo)</small>	11/2011 - 02/2017	555500	BMA		450,00 ◦	1500	8,00	80	A	766107	U	7	98,00	G	•				
										766113	U	13	120,00	F	•				
											716644		13	205,00	G	• • S B E			
i30 5 puertas (PD) <small>(excluido i30 N, fastback)</small>	03/2017 - 08/2018	630900	Cisne		209,00	1500	8,30	80	A	766107	U	7	98,00	G	•				
		631000	BMA		399,00	1500	8,30	80	A	766113	U	13	120,00	F	•				
											716724		13	220,00	G	• • S B E			
i30 CW (FD)	10/2007 - 06/2012	490800	Cisne		229,00 ◦	1500	8,60	75	B	766107	U	7	98,00	F	•				
		521800	BMA		399,00 ◦	1500	8,60	75	B	766113	U	13	120,00	G	•				
i30 CW (GD)	06/2012 - 05/2017	561000	Cisne		225,00 ◦	1500	8,00	75	B	766107	U	7	98,00	F	•				
		561100	BMA		375,00 •	1500	8,00	75	B	766113	U	13	120,00	G	•				
											716644		13	205,00	G	• • S B E			
i30 CW (PD)	05/2017 -	641000	Cisne		225,00	1500	8,30	80	A	766107	U	7	98,00	F	•				
		641100	BMU		455,00 ◦	1500	8,30	80	A	766113	U	13	120,00	G	•				
											716724		13	220,00	G	• • S B E			
i30 Fastback <small>(excluido i30 N, N-Line)</small>	01/2018 -	653300	Cisne		255,00	1400	7,90	80	A	766107	U	7	98,00	F	•				
		653400	BMA		395,00 ◦	1400	7,90	80	A	766113	U	13	120,00	G	•				
											716724		13	220,00	G	• • S B E			
i40 (VF) <small>(excluido Adblue)</small>	03/2012 -	555600	Cisne		225,00 •	1800	9,55	80	A	766107	U	7	98,00	F	•				
		555700	BMAh		405,00 •	1800	9,55	80	A	766113	U	13	120,00	G	•				
											716632		13	170,00	F	• • • B E			
i40 CW (VF) <small>(excluido Adblue)</small>	07/2011 -	546800	Cisne		235,00	1800	9,55	80	A	766107	U	7	98,00	F	•				
		546900	BMAh		415,00 •	1800	9,55	80	A	766113	U	13	120,00	G	•				
		547000	MX		915,00 ◦	1800	9,55	80	A	716632		13	170,00	F	• • • B E				
i800 (TQ)	02/2008 -	516100	Cisne		309,00 ◦	2400	14,01	100	B	766007	U	7	13,50	E					
										766013	U	13	39,50	F					
											716584		13	215,00	F	• • • B E			
ix20 (JC) <small>(536900, incluido GLP)</small>	11/2010 -	536800	Cisne		199,00 ◦	1300	7,70	75	B	766107	U	7	98,00	G	•				
		536900	BMA		379,00 ◦	1300	7,70	75	B	766113	U	13	120,00	F	•				
ix35 (LM,EL,ELH) <small>(incluido 4x4)</small>	08/2009 - 09/2015	529300	Cisne		209,00 ◦	2200	10,70	80	A	766107	U	7	98,00	F	•				
		529400	BMA		389,00 •	2200	10,70	80	A	766113	U	13	120,00	G	•				
		527500	MX		889,00 ◦	2200	10,70	80	A	716604		13	209,00	G	• • S B E				
Kona <small>(excluido Adblue, 4WD, Hybrid, eléctrico)</small>	01/2018 -	646500	Cisne		209,00	1250	8,50	80	A	766107	U	7	98,00	F	•				
		646600	BMAh		389,00	1250	8,50	80	A	766113	U	13	120,00	G	•				
											716754		13	188,00	G	• • S C N			

* Hasta finalización de stock



Datos vehículo		Datos enganche										Datos kit eléctrico									
 		        										         									
Kona (sólo eléctrico) (Consultar el listado de portabicicletas válidos para la bola RMC)	01/2018 -	663845	RMCh		860,00	0	0	80	A	Incluido	U	13	98,00	G	•	•	S	C	N		
Matrix (FC)	06/2001 - 08/2010	399100	Cisne		245,00	1300	7,60	52	A	766007	U	7	13,50	E							
Santa Fe (SM) (incluido 4WD)	11/2000 - 03/2006	335700	Cisne		335,00	•	2300	11,50	92	B	766007	U	7	13,50	E						
Santa Fe (CM) (incluido 4WD) (518400: excluido con embellecedor en paragolpes)	11/2005 - 08/2012	465700	Cisne		275,00	•	2500	12,50	100	B	766007	U	7	13,50	E						
		518400	BMA		455,00	•	2500	12,50	100	B	766013	U	13	39,50	F						
Santa Fe (DM) (incluido 4WD)	09/2012 - 07/2018	564200	Cisne		249,00	•	2500	12,60	100	B	766107	U	7	98,00	F	•					
		564300	BMA		429,00	•	2500	12,60	100	B	766113	U	13	120,00	G	•					
		590600	BMU		469,00	◦	2500	12,60	100	B	716674		13	205,00	G	•	•	S	B	E	
Santa Fe (TM) (648900, 649000: excluido Adblue) (665000, 665100: incluido Adblue)	08/2018 -	648900	* Cisne		309,00	•	2500	12,60	100	B	766107	U	7	98,00	F	•					
		649000	* BMU		519,00	•	2500	12,60	100	B	766113	U	13	120,00	G	•					
		665000	Cisne		409,00	•	2500	12,70	100	B	716764	4	13	187,00	G	•	•	S	C	E	
		665100	BMU		619,00	•	2500	12,70	100	B											
Satelite/Starex (excluido 4WD)	10/1997 - 12/2000	396300	Cisne		250,00	◦	1800	11,20	75	B	766007	U	7	13,50	E						
											766013	U	13	39,50	F						
Sonata V (NF)	01/2005 - 12/2010	439500	Cisne		285,00	•	1700	9,00	80	B	766007	U	7	13,50	E						
											766013	U	13	39,50	F						
Tucson (JM) (incluido 4WD)	08/2004 - 03/2010	430200	Cisne		305,00	◦	1800	9,00	75	B	766007	U	7	13,50	E						
		430300	BMA		445,00	◦	1800	9,00	75	B	766013	U	13	39,50	F						
Tucson (TL) (excluido Adblue)	05/2015 - 08/2018	613700	Cisne		220,00		2200	11,00	100	A	766107	U	7	98,00	F	•					
		613800	BMA		400,00	◦	2200	11,00	100	A	766113	U	13	120,00	G	•					
		610200	MX		900,00	◦	2200	11,00	100	A	716704		13	179,00	G	•	•	•	•	C	D
Tucson (TL) (incluido Adblue) (excluido N-Line)	09/2018 -	659300	Cisne		269,00		1900	11,00	100	A	766107	U	7	98,00	F	•					
		659400	BMU		479,00	◦	1900	11,00	100	A	766113	U	13	120,00	G	•					
		659500	MX		949,00	◦	1900	11,00	100	A	716774		13	205,00	G	•			S	C	N

Datos vehículo	Datos enganche	Datos kit eléctrico
 	       	         









INFINITY

FX 30	10/2008 -	550900 BMA  685,00 ◦ 1800 12,10 100 C	766107 U 7 98,00 F • 766113 U 13 120,00 G •
FX 37	10/2008 -	550900 BMA  685,00 ◦ 1800 12,10 100 C	766107 U 7 98,00 F • 766113 U 13 120,00 G •
FX 50	10/2008 -	550900 BMA  685,00 ◦ 1800 12,10 100 C	766107 U 7 98,00 F • 766113 U 13 120,00 G •
QX 70	8/2013 -	550900 BMA  685,00 ◦ 1800 12,10 100 C	766107 U 7 98,00 F • 766113 U 13 120,00 G •

















ISUZU

D-Max (TFR,TFS) (incluido 4WD)	06/2012 -	570600 Placa  369,00 3000 15,00 120 A	766107 U 7 98,00 F • 766113 U 13 120,00 G •
Rodeo (incluido 4WD)	01/2007 - 06/2012	488500 * Placa  309,00 ◦ 3000 14,60 120 A	766007 U 7 13,50 E 766013 U 13 39,50 F





































* Hasta finalización de stock

Datos vehículo		Datos enganche							Datos kit eléctrico					
														
IVECO														
Daily Furgón 30S-35S (distancia entre ejes 3,52m y longitud 5,96m) (vehículos con escalón)	03/2014 -	593200	Placa 	380,00	3500	23,00	280	B	766107	U 7	98,00	F •		
		593201	Mixta 	500,00	3400	23,00	280	B	766113	U 13	120,00	F •		
Daily Furgón 30S-35S-35C-40C-50C (excluido distancia entre ejes 3,30m) (vehículos con escalón)	03/2014 -	621600	4F 	460,00	3500	20,20	250	B	766107	U 7	98,00	F •		
									766113	U 13	120,00	F •		
Daily Furgón 60C-70C (vehículos con escalón)	03/2014 -	623300	4F 	460,00	3500	22,90	250	B	766107	U 7	98,00	F •		
									766113	U 13	120,00	F •		
Daily Chasis 30S-35S-35C-40C-50C (excluido distancia entre ejes 3,30m)	03/2014 -	621600	4F 	460,00	3500	20,20	250	B	766107	U 7	98,00	F •		
									766113	U 13	120,00	F •		
Daily Chasis 60C-70C	03/2014 -	623300	4F 	460,00	3500	22,90	250	B	766107	U 7	98,00	F •		
									766113	U 13	120,00	F •		







































JAGUAR													
F-Pace (incluido R-Sport, S, First Edition)	09/2015 -	616400	Cisne 	375,00	2400	12,20	175	B	766107	U 7	98,00	F •	
		616500	BMU 	605,00	2400	12,20	175	B	766113	U 13	120,00	G •	
F-Pace (X590)	02/2018 -	667500	BMU 	605,00	750	5,80	50	B	766107	U 7	98,00	F •	
									766113	U 13	120,00	G •	
									744584	U 7	06/2018-	90,00	F •
XE (X760) (excluido XE S, 3.0 V6 gasolina)	03/2015 -	602600	Cisne 	285,00	1800	10,20	75	B	766107	U 7	98,00	F •	
		602700	BMU 	515,00	1800	10,20	75	B	766113	U 13	120,00	G •	
XF-Type (X250) (incluido S modelos, Sportbreak)	03/2008 - 04/2015	478700	BMAh 	545,00	1850	11,00	75	B	766107	U 7	98,00	F •	
									766113	U 13	120,00	G •	









Datos vehículo		Datos enganche							Datos kit eléctrico						
															
JEEP															
Cherokee (KJ)	09/2001 - 12/2007	467700	Cisne		285,00	3500	14,40	140	A	766007	U	7	13,50	E	
		458800	BMAh		465,00	3500	15,10	140	A	766013	U	13	39,50	F	
Cherokee (KK)	01/2008 - 10/2013	473200	Cisne		250,00 •	2500	13,00	100	A	766107	U	7	98,00	F •	
		473300	BMA		430,00 •	2500	13,00	100	A	766113	U	13	120,00	G •	
										704514		13	210,00	G • • • B E	
Cherokee (KL) <small>(incluido 4WD) (excluido Trailhawk)</small>	11/2013 -	588400	Cisne		265,00 ◦	2500	13,00	90	B	766107	U	7	98,00	F •	
		588500	BMU		485,00 ◦	2500	13,00	90	B	766113	U	13	120,00	G •	
									719654		13	-06/2018	235,00	G • • • S C E	
Commander (XK)	09/2005 - 12/2010	379900	Cisne		225,00 ◦	3500	15,90	350	A	766107	U	7	98,00	F •	
		380000	BMA		435,00 •	3500	15,90	350	A	766113	U	13	120,00	G •	
										719574		13		205,00	G • • • S B F
Compass (PK) <small>(excluido Rallye)</small>	08/2006 - 01/2011	452400	Cisne		209,00 ◦	1500	8,00	105	A	766107	U	7	98,00	F •	
									766113	U	13	120,00	G •		
										704504		13	190,00	G • • B E	
Compass (MK)	02/2011 - 05/2017	545400	Cisne		215,00 ◦	2000	10,20	105	A	766107	U	7	98,00	F •	
		538300	BMAh		395,00 •	2000	10,20	105	A	766113	U	13	120,00	G •	
										704504		13	190,00	G • • B E	
Compass (MX) <small>(643600, incluido Adblue) (605000, incluido Adblue, Trailhawk)</small>	06/2017 -	643600	Cisne		259,00	1500	10,50	100	B	766107	U	7	98,00	F •	
		605000	BMU		449,00 ◦	1500	10,50	100	B	766113	U	13	120,00	G •	
										719674		13	180,00	G • • • S B E	

* Hasta finalización de stock





















Datos vehículo		Datos enganche								Datos kit eléctrico										
 		       								          										
Grand Cherokee II (WJ/WG)	09/1998 - 09/2005	277700	Cisne		290,00	3500	14,30	140	A	766007	U	7	13,50	E						
		458900	BMA		500,00	3500	14,30	140	A	766013	U	13	39,50	F						
Grand Cherokee III (WH,WK)	06/2005 - 12/2010	379900	Cisne		225,00	3500	15,90	350	A	766107	U	7	98,00	F	•					
		380000	BMA		435,00	3500	15,90	350	A	766113	U	13	120,00	G	•					
										719574		13	06/2006-	205,00	G	•	•	•	S	B
Grand Cherokee IV (WK) (excluido SRT8)	11/2010 - 04/2013	541900	Cisne		285,00	3500	16,20	175	A	766107	U	7	98,00	F	•					
		542000	BMA		465,00	3500	16,20	175	A	766113	U	13	120,00	G	•					
										719591		7		90,00	E	•	•			G
Grand Cherokee IV (WK) (desde 09/2018 excluido Adblue) (excluido SRT8)	05/2013 -	582900	Cisne		305,00	3500	16,20	175	A	766107	U	7	98,00	F	•					
		583000	BMU		515,00	3500	16,20	175	A	766113	U	13	120,00	G	•					
										719684		13		270,00	H	•	•	•	C	E
Grand Cherokee IV Summit (WK)	05/2013 -	583300	BMU		515,00	3500	16,20	175	A	766107	U	7	98,00	F	•					
										766113	U	13	120,00	G	•					
										719684		13		270,00	H	•	•	•	C	E
Patriot (PK)	02/2007 - 01/2011	452400	Cisne		209,00	1500	8,00	105	A	766107	U	7	98,00	F	•					
										766113	U	13	120,00	G	•					
										704504		13		190,00	G	•	•		B	E
Patriot (MK)	02/2011 -	545400	Cisne		215,00	2000	10,20	105	A	766107	U	7	98,00	F	•					
		538300	BMAh		395,00	2000	10,20	105	A	766113	U	13	120,00	G	•					
										704504		13		190,00	G	•	•		B	E
Renegade (BU) (incluido TrailHawk)	07/2014 -	643600	Cisne		259,00	1500	9,50	75	B	766107	U	7	98,00	F	•					
		605000	BMU		449,00	1500	10,50	100	B	766113	U	13	120,00	G	•					
										719674		13		180,00	G	•	•	•	S	B
Wrangler III (JK) (incluido Adblue, Rubicon)	04/2007 -	664400	BMA		415,00	3500	15,30	350	A	766107	U	7	98,00	F	•					
										766113	U	13	120,00	G	•					
										719584		13	-07/2018	295,00	H	•	•	•	C	E
										719694		13	08/2018-	295,00	G	•	•	S	M	N

Datos vehículo		Datos enganche										Datos kit eléctrico										
Niro <small>(sólo e-niro)</small> <small>(Consultar el listado de portabicicletas válidos para la bola RMC)</small>	10/2018 -	663245	RMCu		945,00	◦	0	0	75	A	Incluido	13				G	•	•	•	S	G	G
Optima (TF)	01/2012 - 12/2015	557600 *	Cisne		220,00	•	1800	9,00	80	B	766107	U 7	98,00	F	•							
Optima <small>(excluido GT-Line, Hybrid)</small>	01/2016 -	625400	Cisne		245,00	◦	1800	10,00	85	B	766107	U 7	98,00	F	•							
		625500	BMU		465,00	◦	1800	10,00	85	B	766113	U 13	120,00	G	•							
											720584	13	147,00	G	•		•	S	G	G		
Optima Sport Wagon <small>(incluido GT-Line)</small> <small>(excluido Hybrid, Adblue)</small>	09/2016 -	625400	Cisne		245,00	◦	1800	10,00	85	B	766107	U 7	98,00	F	•							
		625500	BMU		465,00	◦	1800	10,00	85	B	766113	U 13	120,00	G	•							
											720684	13	195,00	G	•		•	S	G	G		
Picanto (BA)	04/2004 - 04/2011	427200	Cisne		205,00	•	700	5,00	28	B	766007	U 7	13,50	E								
											766013	U 13	39,50	F								
Picanto (TA) <small>(incluido X-treme)</small>	05/2011 - 02/2015	550600	BMA		408,00	•	700	5,50	28	A	766107	U 7	98,00	F	•							
											766113	U 13	120,00	G	•							
Picanto (TA)	05/2011 - 02/2015	543500 *	BMA		275,00	•	700	5,50	28	A	766107	U 7	98,00	F	•							
											766113	U 13	120,00	G	•							
Pro-Cee'd 3 puertas (ED)	02/2008 - 02/2013	498600	BMA		394,00	◦	1800	9,10	75	A	766107	U 7	98,00	F	•							
											766113	U 13	120,00	G	•							
											720424	13	168,00	G	•		•	•				
Pro-Cee'd GT 3 puertas (JD) <small>(incluido GT)</small>	03/2013 - 02/2019	592500	BMA		445,00	•	1400	8,50	75	B	766107	U 7	98,00	F	•							
											766113	U 13	120,00	G	•							
											720594	13	149,00	H	•		•	S	B	E		
Pro-Cee'd GT 5 puertas (CD) <small>(excluido GT-Line)</small>	03/2019 -	674600	Cisne		239,00		1500	8,41	75	B	766107	U 7	98,00	F	•							
		674700	BMU		449,00		1500	8,41	75	B	766113	U 13	120,00	G	•							
Rio 5 puertas (JB) <small>(excluido modelos con paquete de deporte)</small>	09/2009 - 08/2011	536400 *	Cisne		175,00	◦	1100	6,50	60	A	766107	U 7	98,00	F	•							
		536500 *	BMAh		355,00	◦	1100	6,50	60	A	766113	U 13	120,00	G	•							



















Datos vehículo		Datos enganche										Datos kit eléctrico									
 		         										          									
Sportage (JA/K00)	04/1994 - 08/2004	250100 *	Cisne		270,00	2000	9,90	70	B	766007	U	7	13,50	E							
										766013	U	13	39,50	F							
Sportage (JE/KM)	09/2004 - 06/2010	444100	Cisne		259,00 ^o	2000	10,30	80	B	766007	U	7	13,50	E							
		464200	BMA		439,00 ^o	2000	10,30	80	B	766013	U	13	39,50	F							
Sportage (SL)	06/2010 - 12/2015	529300	Cisne		209,00 ^o	2200	10,70	80	A	766107	U	7	98,00	F	•						
		529400	BMA		389,00 [•]	2200	10,70	80	A	766113	U	13	120,00	G	•						
										720634		13	182,00	H	•	•	S	C	E		
Sportage (QL) <small>(excluido Adblue)</small>	01/2016 - 09/2018	613700	Cisne		220,00 ^o	2200	11,00	100	A	766107	U	7	98,00	F	•						
		613800	BMA		400,00 ^o	2200	11,00	100	A	766113	U	13	120,00	G	•						
										716704		13	179,00	G	•	•	•	•	C	D	
Sportage (QL) <small>(Incluido Adblue, GT-Line)</small>	10/2018 -	659300	Cisne		269,00	1900	11,00	100	A	766107	U	7	98,00	F	•						
		659400	BMU		479,00 ^o	1900	11,00	100	A	766113	U	13	120,00	G	•						
		659500	MX		949,00 ^o	1900	11,00	100	A												
Stonic (YB)	09/2017 -	644700	Cisne		209,00 ^o	1100	6,60	75	A	766107	U	7	98,00	F	•						
		644800	BMAh		389,00 ^o	1100	6,60	75	A	766113	U	13	120,00	G	•						
										720714		13	194,00	G	•	•	S	C	N		
Venga (YN)	02/2010 -	536800	Cisne		199,00 ^o	1300	7,70	75	A	766107	U	7	98,00	F	•						
		536900	BMA		379,00 ^o	1300	7,70	75	A	766113	U	13	120,00	G	•						
										720504		13	131,00	H	•	•	S	B	E		
Xceed (CD)	06/2019 -	678800	Cisne		235,00 ^o	1500	8,50	75	B	766107	U	7	98,00	F	•						
		678900	BMA		445,00 [•]	1500	8,50	75	B	766113	U	13	120,00	G	•						

Datos vehículo		Datos enganche							Datos kit eléctrico						
															
LANCIA															
Delta (844)	08/2008 - 12/2015	510200	Cisne		209,00 ^o	1300	7,70	90	B	766107	U 7	98,00 F •			
		484200	BMA		389,00 •	1300	7,70	60	B	766113	U 13	120,00 G •			
										722634	13	217,00 G • • C E			
Musa (350)	10/2004 - 09/2012	509500	Cisne		219,00 ^o	1200	6,80	80	C	766107	U 7	98,00 F •			
										766113	U 13	120,00 G •			
Phedra (179)	09/2002 - 11/2010	365600	Cisne		245,00 ^o	1900	11,30	76	A	766107	U 7	98,00 F •			
		365700 *	BMC		425,00 •	1900	11,30	76	A	766113	U 13	120,00 G •			
										705604	13 11/2005-	220,00 H • • • D B E			
Voyager (RT) <small>(incluido Stow 'n Go)</small> <small>(473000: excluido con sensor de marcha atrás)</small>	09/2011 - 12/2015	473000	Cisne		260,00 ^o	2000	11,50	200	B	766107	U 7	98,00 F •			
		473100	BMA		440,00 ^o	2000	11,50	200	B	766113	U 13	120,00 G •			
										704084	13	180,00 H • • • C E			
Ypsilon (840A)	11/1995 - 09/2003	232400	Cisne		185,00 •	1300	6,80	70	A	766007	U 7	13,50 E			
										766013	U 13	39,50 F			
Ypsilon 5 puertas (846) <small>(incluido TwinAir)</small>	05/2011 -	548200	Cisne		200,00 •	1000	6,10	60	B	766107	U 7	98,00 F •			
		547900	BMA		380,00 ^o	1000	6,10	60	B	766113	U 13	120,00 G •			
Zeta (220)	05/1995 - 09/2002	316600	Cisne		184,00 ^o	1900	10,20	80	A	766007	U 7	13,50 E			
										766013	U 13	39,50 F			

* Hasta finalización de stock

Datos vehículo	Datos enganche	Datos kit eléctrico
 	      	          

LAND ROVER

Defender 90/110 (LD) <small>(excluido 130 Pick-up)</small>	09/1998 - 02/2016	316400 Placa  169,00 3500 17,41 250 A	766007 U 7 13,50 E
		316401 Mixta  289,00 3400 17,41 250 A	766013 U 13 39,50 F
Discovery 3 (TAA)	07/2004 - 09/2009	377140 BMU  680,00 3500 16,70 150 A	Incluido
Discovery 4 (LA) <small>(TOWKIT sólo bola desmontable, incluido Kit eléctrico)</small>	09/2009 - 05/2017	377141 BMU  680,00 3500 16,70 150 A	Incluido
Discovery Sport (LC) <small>(incluido 4WD) (excluido 7 plazas con rueda de respuesto)</small>	01/2015 - 07/2019	596700 Cisne  400,00 2500 12,30 175 B	766107 U 7 98,00 F •
		596800 BMA  510,00 2500 12,30 175 B	766113 U 13 120,00 G •
			744694 13 139,00 E • • • C F
Freelander I (LN) <small>(incluido Soft Top)</small>	02/1998 - 10/2006	382200 Placa  219,00 ◦ 2000 10,00 140 A	766007 U 7 13,50 E
		382300 BMC  399,00 ◦ 2000 10,00 140 A	766013 U 13 39,50 F
Freelander 2 (FA)	10/2006 - 10/2014	435700 Cisne  275,00 • 2000 11,00 150 B	766107 U 7 98,00 F •
		424800 BMA  455,00 • 2000 11,00 150 B	766113 U 13 120,00 G •
Range Rover III (LM) <small>(sólo motor BMW, incluido Vogue) (excluido motor Ford y Vogue)</small>	03/2002 - 05/2005	402800 BMC  495,00 3500 16,40 150 B	766107 U 7 98,00 F •
			766113 U 13 120,00 F
Range Rover Evoque (LV) <small>(590700 incluido Adblue)</small>	06/2011 - 02/2019	547600 Cisne  230,00 • 1800 10,00 150 B	766107 U 7 98,00 F •
		590700 BMU  570,00 • 1800 10,00 150 B	766113 U 13 120,00 G •
			744234 13 110,00 E • • • • C F
Range Rover Sport (LS) <small>(TOWKIT sólo bola desmontable, incluido Kit eléctrico)</small>	02/2005 - 08/2009	377140 BMU  680,00 3500 16,70 150 A	Incluido F • • S C F
Range Rover Sport (LS) <small>(TOWKIT sólo bola desmontable, incluido Kit eléctrico)</small>	09/2009 - 08/2011	377141 BMU  680,00 3500 16,70 150 A	Incluido F • • D C F
Range Rover Sport (LS) <small>(TOWKIT sólo bola desmontable, incluido Kit eléctrico)</small>	09/2011 - 07/2013	377142 BMU  680,00 3500 16,70 150 A	Incluido E • • D C F
Range Rover Sport (LW) <small>(incluido PHEV Hybrid) (excluido SVR, P400e)</small>	04/2013 -	576700 Cisne  349,00 • 3500 16,80 200 C	766107 U 7 98,00 F •
		576800 BMA  539,00 • 3500 16,80 200 C	766113 U 13 120,00 G •
			744264 13 89,00 F • ◦ D C F

Datos vehículo	Datos enganche	Datos kit eléctrico
----------------	----------------	---------------------





















LEXUS





































LX570	11/2007 -	424500	Cisne		209,00 ◦	3500	17,40	140	B	766107	U	7	98,00	F	•
		424600	Placa		235,00 ◦	3500	17,40	140	B	766113	U	13	120,00	G	•
		424700	BMA		445,00 ◦	3500	17,40	140	B						
RX300	02/2003 - 01/2006	365300	Cisne		339,00 ◦	2425	11,80	90	B	766107	U	7	98,00	F	•
										766113	U	13	120,00	G	•
RX350	02/2006 - 12/2008	365300	Cisne		339,00 ◦	2425	11,80	90	B	766107	U	7	98,00	F	•
										766113	U	13	120,00	G	•
RX400h (excluido RX450h)	11/2004 - 12/2008	365300	Cisne		339,00 ◦	2425	11,80	90	B	766107	U	7	98,00	F	•
										766113	U	13	120,00	G	•

MAN

TGE Furgón (633200, sin escalón) (645100, con escalón) (excluido 4WD y ruedas gemelas)	04/2017 -	633200	Placa		295,00	3500	17,50	140	B	766107	U	7	98,00	F	•
		645100	Placa		375,00	3500	17,50	140	B	766113	U	13	120,00	G	•
		633201	Mixta		415,00	3400	17,50	140	B	756874	3	13	80,00	F	• • • C G
		645101	Mixta		495,00	3400	17,50	140	B	756884	2	13	245,00	G	• • ◦ ◦ C F

* Hasta finalización de stock







































Datos vehículo		Datos enganche								Datos kit eléctrico							
																	
MAZDA																	
2 3-5 puertas (DE,DH)	06/2007 - 11/2014	473500	Cisne		183,00	1000	7,00	80	A	766107	U 7	98,00	F •				
		473600	BMA		363,00 •	1000	7,00	80	A	766113	U 13	120,00	G •				
2 5 puertas (DL,DJ)	12/2014 -	601900	Cisne		189,00 •	1200	7,00	50	A	766107	U 7	98,00	F •				
		602000	BMA		379,00 •	1200	7,00	50	A	766113	U 13	120,00	G •				
										724571	7	99,00	F • • • G G				
3 3-5 puertas (BK) <small>(incluido Sport)</small>	10/2003 - 12/2009	425300	BMA		385,00 ◦	1500	8,00	75	A	766007	U 7	13,50	E				
										766013	U 13	39,50	F				
3 3-5 puertas (BL) <small>(excluido MPS, Sport)</small>	12/2009 - 08/2013	522600	BMA		385,00	1600	8,00	75	A	766107	U 7	98,00	F •				
										766113	U 13	120,00	G •				
										724544	13	160,00	G • • • B E				
3 3-5 puertas (BL,BM) <small>(incluido Skyactiv)</small>	09/2013 - 03/2019	584400	Cisne		209,00 •	1800	9,50	90	A	766107	U 7	98,00	F •				
		584500	BMU		419,00 •	1800	9,50	90	A	766113	U 13	120,00	G •				
										724564	13	142,00	G • • • C E				
3 5 puertas (BP)	04/2019 -	669100	Cisne		265,00	1300	8,50	80	A	766107	U 7	98,00	F •				
		669200	BMAh		435,00 ◦	1300	8,50	80	A	766113	U 13	120,00	G •				
										724634	13	195,00	G • • • C N				
3 Sedan (BK) <small>(excluido paragolpes Sport)</small>	09/1999 - 06/2009	439200	Cisne		195,00 ◦	1500	8,00	75	A	766007	U 7	13,50	E				
		425300	BMA		385,00	1500	8,00	75	A	766013	U 13	39,50	F				
3 Sedan (BL)	01/2009 - 08/2013	522800 *	BMA		385,00	1600	8,00	75	A	766107	U 7	98,00	F •				
										766113	U 13	120,00	F •				
										724544	13	160,00	G • • • B E				
3 Sedan (BL,BM) <small>(incluido Skyactiv)</small> <small>(excluido para cabezal AK2000)</small>	09/2013 - 03/2019	584600	BMU		489,00 ◦	1800	9,50	90	A	766107	U 7	98,00	F •				
										766113	U 13	120,00	G •				
										724564	13	142,00	G • • • C E				
3 Sedan (BP) <small>(incluido Skyactiv)</small> <small>(excluido para cabezal AK2000)</small>	04/2019 -	683900	Cisne		255,00					766107	U 7	98,00	F •				
		684000	BMU		465,00					766113	U 13	120,00	G •				
										724564	13	142,00	G • • • C E				
5 (CR) <small>(excluido Sport)</small>	02/2005 - 08/2010	535500	Cisne		199,00 ◦	1600	9,00	75	B	766107	U 7	98,00	F •				
	01/2008 - 08/2010	501100	BMAh		379,00 •	1600	9,00	85	B	766113	U 13	120,00	G •				
										724534	13	210,00	G • • • B E				

Datos vehículo		Datos enganche								Datos kit eléctrico																																	
																																											
5 (CW) (excluido Sport)	09/2010 -	535500	Cisne		199,00	◦	1600	9,00	75	B	766107	U	7	98,00	F	•																											
		501100	BMAh		379,00	•	1600	9,00	85	B	766113	U	13	120,00	G	•																											
6 5 puertas (GG) (incluido 4WD) (excluido MPS)	06/2002 - 12/2008	379000	Cisne		235,00	•	1800	9,40	75	B	766107	U	7	98,00	F	•																											
											766113	U	13	120,00	G	•																											
6 5 puertas (GH)	08/2007 - 07/2013	499600	Cisne		235,00	◦	1800	9,50	75	B	766107	U	7	98,00	F	•																											
											766113	U	13	120,00	G	•																											
6 Sedán (GG) (incluido 4WD)(excluido MPS)	06/2002 - 12/2008	379000	Cisne		235,00	•	1800	9,40	75	B	766107	U	7	98,00	G	•	•																										
											766113	U	13	120,00	G	•	•																										
6 Sedán (GH)	08/2007 - 10/2012	499600	Cisne		235,00	◦	1800	9,50	75	B	766107	U	7	98,00	F	•																											
											766113	U	13	120,00	G	•																											
6 Sedán (GJ,GL) (excluido Adblue)	10/2012 - 06/2018	576200	Cisne		222,00	◦	1800	10,00	75	B	766107	U	7	98,00	F	•																											
		576300	BMA		402,00	◦	1800	10,00	75	B	766113	U	13	120,00	G	•																											
6 Sedán (GJ,GL) (incluido Adblue)	07/2018 -	670100	Cisne		245,00	◦	1800	10,00	75	B	766107	U	7	98,00	F	•																											
		670200	BMA		455,00	◦	1800	10,00	75	B	766113	U	13	120,00	G	•																											
6 Break (GY/GG1) (incluido 4WD) (excluido MPS)	08/2002 - 12/2007	379200	Cisne		259,00	•	1800	9,40	75	B	766107	U	7	98,00	F	•																											
											766113	U	13	120,00	G	•																											
6 Wagon (GH)	02/2008 - 11/2012	535300	Cisne		230,00	◦	1800	9,00	100	B	766107	U	7	98,00	F	•																											
		535400	BMAh		410,00	◦	1800	9,00	100	B	766113	U	13	120,00	G	•																											
6 Wagon (GJ,GL) (excluido Adblue, 4WD)	12/2012 - 06/2018	576200	Cisne		222,00	◦	1800	10,00	75	B	766107	U	7	98,00	F	•																											
		576300	BMA		402,00	◦	1800	10,00	75	B	766113	U	13	120,00	G	•																											
6 Wagon (GJ,GL) (incluido Adblue)	07/2018 -	670100	Cisne		245,00	◦	1800	10,00	75	B	766107	U	7	98,00	F	•																											
		670200	BMA		455,00	◦	1800	10,00	75	B	766113	U	13	120,00	G	•																											
											724514	13	144,00	G	•	•																											
											724624	13	179,00	H	•	•																											

* Hasta finalización de stock

Datos vehículo		Datos enganche							Datos kit eléctrico						
MERCEDES															
A (W168) (excluido pack AMG)	06/1997 - 08/2004	332500	Cisne		185,00 ◦	1000	6,20	50	A	766107	U 7	98,00 F •			
										766113	U 13	120,00 G •			
										727004	13	145,00 H • • • B D			
A (W169)	09/2004 - 06/2012	443000	Cisne		235,00 ◦	1500	8,50	80	A	766107	U 7	98,00 F •			
		443100	BMA		415,00 ◦	1500	8,50	80	A	766113	U 13	120,00 G •			
										727434	13	195,00 H • • ◦ ◦ M N			
A (W176) (excluido pack AMG, AMG) (608600: hasta 08/2015 excluido pack AMG, AMG) (608600: desde 09/2015 incluido pack AMG, excluido AMG)	06/2012 - 06/2018	576500	Cisne		199,00	1500	9,20	80	B	766107	U 7	98,00 F •			
		608600	BMU		439,00	1500	9,20	80	B	766113	U 13	120,00 G •			
A (W177) (incluido Pack AMG)	07/2018 -	652100	Cisne		249,00 ◦	2000	10,00	80	B	766109	U 7	102,00 F •			
		652200	BMU		459,00 ◦	2000	10,00	80	B	766119	U 13	120,00 G •			
										727654	13	180,00 G • • D D C N			
A Berlina (W177) (incluido Pack AMG)	09/2018 -	652100	Cisne		255,00 ◦	2000	10,00	80	B	766109	U 7	102,00 F •			
		652200	BMU		475,00 ◦	2000	10,00	80	B	766119	U 13	120,00 G •			
										727654	13	180,00 G • • D D C N			
B (W245)	03/2005 - 11/2011	443000	Cisne		235,00 ◦	1500	8,50	80	A	766107	U 7	98,00 F •			
		443100	BMA		415,00 ◦	1500	8,50	80	A	766113	U 13	120,00 G •			
										727434	13	195,00 H • • ◦ ◦ M N			
B (W246) (excluido pack AMG, AMG)	11/2011 - 02/2019	576500	Cisne		199,00	1500	9,00	80	B	766109	U 7	102,00 F •			
		608600	BMU		439,00	1500	9,20	80	B	766119	U 13	120,00 G •			
		552300	MX		900,00 ◦	1500	9,00	80	B	727614	13	185,00 H • • D D C N			
B (W247) (incluido Pack AMG, apertura maletero con pie)	03/2019 -	652100	Cisne		249,00 ◦	2000	10,00	80	B	766109	U 7	102,00 F •			
		652200	BMU		459,00 ◦	2000	10,00	80	B	766119	U 13	120,00 G •			
										727654	13	180,00 G • • D D C N			

* Hasta finalización de stock







































Datos vehículo		Datos enganche										Datos kit eléctrico									
 		         										          									
C Berlina (W202) (excluido pack AMG, AMG)	03/1993 - 05/2000	288300	Cisne		250,00 •	1650	9,10	75	B	766107	U	7	98,00	F	•						
										766113	U	13	120,00	G	•						
C Berlina (W203) (excluido CLK, Sport-Coupé CL203, Pack AMG, AMG)	05/2000 - 08/2007	352600	Cisne		305,00	1500	8,50	75	C	766107	U	7	98,00	F	•						
		432700	BMA		485,00	1500	8,50	75	C	766113	U	13	120,00	G	•						
										727414		13	215,00	G	• • ° ° C E						
C Berlina (W204) (excluido pack AMG, AMG)	01/2007 - 01/2014	493400	Cisne		249,00 •	1900	10,00	100	B	766107	U	7	98,00	F	•						
		493500	BMA		449,00 •	1900	10,20	100	B	766113	U	13	120,00	G	•						
		582000	BMU		545,00	1800	10,20	100	B	727534		13	185,00	H	• • D D C N						
		472000	MX		929,00 °	1900	10,20	100	B												
C Berlina (W204) (sólo pack AMG) (excluido AMG)	01/2007 - 01/2014	528500	BMA		475,00	1900	10,00	100	B	766107	U	7	98,00	F	•						
										766113	U	13	120,00	G	•						
										727534		13	185,00	H	• • D D B E						
C Berlina (W205) (incluido 350e Plug-in-hybrid, comprobar MMR) (excluido pack AMG, AMG)	01/2014 -	588200	Cisne		245,00	1900	10,50	75	B	766109	U	7	102,00	F	•						
		588300	BMU		505,00	1900	10,50	75	B	766119	U	13	120,00	G	•						
		601100	MX		945,00	1900	10,50	75	B	727624		13	180,00	H	• • D D B N						
										747014		13	170,00	G	• • D D C N						
C Berlina (W205) (sólo pack AMG)(excluido AMG) (comprobar MMR)	01/2014 -	590300	BMU		535,00	1900	12,00	75	B	766109	U	7	102,00	F	•						
										766119	U	13	120,00	G	•						
										727624		13	180,00	G	• • D D B N						
										747014		13	170,00	G	• • D D C N						
C Break (S202) (excluido pack AMG, AMG)	06/1996 - 03/2001	288300	Cisne		250,00 •	1650	9,10	75	B	766107	U	7	98,00	F	•						
										766113	U	13	120,00	G	•						
C Break (S203) (excluido pack AMG, AMG)	03/2001 - 08/2007	352600	Cisne		305,00	1500	8,50	75	C	766107	U	7	98,00	F	•						
		432700	BMA		485,00	1500	8,50	75	C	766113	U	13	120,00	G	•						
										727414		13	215,00	G	• • ° ° C E						

Datos vehículo		Datos enganche								Datos kit eléctrico										
C Break (S204) (excluido pack AMG & AMG)	08/2007 - 08/2014	493400	Cisne		249,00 •	1900	10,20	100	B	766107	U	7	98,00	F	•					
		493500	BMA		449,00 •	1900	10,20	100	B	766113	U	13	120,00	G	•					
		582000	BMU		545,00 •	1800	10,20	100	B	727534		13	185,00	H	• •	D	D	B	E	
		472000	MX		929,00 °	1900	10,20	100	B											
C Break (S204) (sólo pack AMG) (excluido AMG)	08/2007 - 01/2011	528500	BMA		475,00 •	1900	10,00	100	B	766107	U	7	98,00	F	•					
									766113	U	13	120,00	G	•						
									727534		13	185,00	H	• •	D	D	C	N		
C Break (S205) (excluido pack AMG, AMG) (incluido 350e Plug-in-hybrid, comprobar MMR)	09/2014 -	588200	Cisne		245,00	1900	10,50	75	B	766109	U	7	102,00	F	•					
		588300	BMU		505,00	1900	10,50	75	B	766119	U	13	120,00	G	•					
										727624		13	-06/2018	180,00	G	• •	D	D	B	N
										747014		13	07/2018-	170,00	G	• •	D	D	C	N
C Break (S205) (sólo pack AMG)(excluido AMG) (comprobar MMR)	09/2014 -	590300	BMU		535,00	1900	12,00	75	B	766109	U	7	102,00	F	•					
									766119	U	13	120,00	G	•						
										727624		13	-06/2018	180,00	G	• •	D	D	B	N
										747014		13	07/2018-	170,00	G	• •	D	D	C	N
C Coupé (C204) (incluido Pack AMG) (excluido AMG)	01/2011 - 01/2014	582000	BMU		545,00 •	1800	10,00	100	B	766107	U	7	98,00	F	•					
									766113	U	13	120,00	G	•						
									727534		13	185,00	H	• •	D	D	B	E		
C Coupé (C205) (sólo Pack AMG) (excluido AMG)	01/2011 - 01/2014	590300	BMU		535,00 •	1900	12,00	75	B	766109	U	7	102,00	F	•					
									766119	U	13	120,00	G	•						
										727624		13	-06/2018	185,00	G	• •	D	D	B	N
										747014		13	07/2018-	170,00	G	• •	D	D	C	N
Citan (W415) (SWB, MWB, LWB) (incluido Adblue) (comprobar MMR)	11/2012 -	566900	Cisne		200,00	1350	8,40	75	A	766107	U	7	98,00	F	•					
		566200	Placa		270,00 °	1350	8,40	75	A	766113	U	13	120,00	G	•					
		566100	BMA		410,00	1350	8,40	75	A	727593		7	115,00	F	• •	S	G	G		
								727594		13	135,00	F	• •	S	B	E				

* Hasta finalización de stock

Datos vehículo		Datos enganche								Datos kit eléctrico					
E Break (S210) <small>(excluido pack AMG, AMG)</small>	06/1996 - 03/2003	244200	Cisne		245,00	2200	11,50	90	B	766107	U	7	98,00	F	•
										766113	U	13	120,00	G	•
E Break (S211) <small>(excluido pack AMG, AMG)</small>	03/2003 - 07/2009	439400	BMA		500,00	2100	11,50	88	B	727424		13	235,00	F	• • • • C E
		471600	MX		939,00	2100	11,50	88	B						
E Break (S212) <small>(excluido pack AMG, AMG, apertura maletero con pie) (582400, incluido pack AMG)</small>	08/2009 - 08/2016	530800	Cisne		245,00	2100	11,64	80	B	766107	U	7	98,00	F	•
		582400	BMU		515,00	2100	11,60	80	B	766113	U	13	120,00	G	•
		531600	MX		915,00	2100	11,64	80	B	727534		13	185,00	H	• • D D C N
E Break (S213) <small>(incluido pack AMG, keyless go, Plug-in Hybrid, Adblue)</small>	09/2016 -	617600	Cisne		325,00	2100	11,60	85	B	766107	U	7	98,00	F	•
		617700	BMA		485,00	2100	11,64	85	B	766113	U	13	120,00	G	•
									747014		13	170,00	F	• • D D C N	
GL (X166) <small>(excluido pack AMG, BlueTec)</small>	07/2012 - 12/2015	580900	BMA		715,00	3500	16,80	135	C	766107	U	7	98,00	F	•
										766113	U	13	120,00	G	•
										727604		13	175,00	F	• • • D C N
GLA (X156) <small>(incluido pack AMG, 4Matic)</small>	01/2014 -	588000	Cisne		260,00	1800	10,00	75	B	766107	U	7	98,00	F	•
		588100	BMU		470,00	1800	10,00	75	B	766113	U	13	120,00	G	•
										727614		13	185,00	H	• • D D C N
GLA (X157)	02/2020 -		Cisne							766109	U	7	102,00	F	•
			BMU							766119	U	13	120,00	G	•
GLB	11/2019 -		Cisne							766109	U	7	102,00	F	•
			BMU							766119	U	13	120,00	G	•
GLC (X253) <small>(incluido Pack AMG, Keyless-go) (excluido Coupe C253, Hybrid) (con el enganche instalado se anula el sistema apertura con pie)</small>	06/2015 -	609100	Cisne		305,00	2500	12,52	100	B	766109	U	7	102,00	F	•
		609200	BMU		498,00	2500	12,52	100	B	766119	U	13	120,00	G	•
		609300	MX		985,00	2500	12,52	100	B	727624		13	-06/2019	180,00	G
									747014		13	07/2019-	170,00	G	• • D D C N

* Hasta finalización de stock





















Datos vehículo		Datos enganche								Datos kit eléctrico						
 		        								          						
GLE (W166) (excluido Pack AMG, AMG) (excluido GLE Coupe C292)	04/2015 - 04/2019	554100	Cisne		309,00	3500	16,80	140	B	766109	U	7	102,00	F	•	
		554200	BMA		559,00	3500	16,80	140	B	766119	U	13	120,00	G	•	
										727584		13	185,00	G	• • D D C E	
GLE (W167)	05/2019 -		Cisne							766109	U	7	102,00	F	•	
			BMU							766119	U	13	120,00	G	•	
GLK (X204) (excluido Pack Sport)	06/2008 - 05/2012	516800	BMAh		439,00	2100	11,20	130	C	766107	U	7	98,00	F	•	
	06/2012 -	579100	BMA		439,00	2500	12,80	100	C	766113	U	13	120,00	G	•	
									727524		13	199,00	G	• • • D B E		
M (W163) (excluido ruedas de recambio en el portón trasero)	02/1998 - 06/2005	349900	Placa		235,00	3500	16,00	150	A	766107	U	7	98,00	F	•	
									766113	U	13	120,00	G	•		
M (W164) (incluido pack AMG) (excluido AMG)	07/2005 - 06/2012	554100	Cisne		309,00	3500	16,80	140	B	766107	U	7	98,00	F	•	
		443300	BMA		609,00	3500	15,40	140	B	766113	U	13	120,00	G	•	
										727504		13	250,00	G	• • • • C E	
M (W166) (incluido 4WD, Pack AMG)	06/2011 -	554100	Cisne		309,00	3500	16,80	140	B	766107	U	7	98,00	F	•	
		554200	BMA		559,00	3500	16,80	140	B	766113	U	13	120,00	G	•	
										727584		13	185,00	G	• • D D C E	
R (W251) (incluido 4Matic)	01/2006 -	461700	BMA		510,00	2100	12,50	85	C	766107	U	7	98,00	F	•	
									766113	U	13	120,00	G	•		
									727484	8	13	260,00	G	• • ° ° C E		
S (W220) (excluido pack AMG, AMG)	01/1998 - 12/2001	468900	BMA		610,00	2100	12,30	85	C	766107	U	7	98,00	F	•	
									766113	U	13	120,00	G	•		
Sprinter Furgón (901/902/903) (distancia entre ejes 3,0 m) (sin escalón)	01/1995 - 05/2006	293100	Placa		340,00	2800	15,30	120	B	766008	U	7	15,00	E		
									766013	U	13	39,50	F			
Sprinter Furgón (901/902/903) (distancia entre ejes 3,55m + 4,02m) (sin escalón + ruedas simples)	01/1995 - 05/2006	293200	Placa		390,00	2800	15,30	120	B	766008	U	7	15,00	E		
									766013	U	13	39,50	F			
Sprinter Furgón (901/902/903) (distancia entre ejes 3,5m + 4,02m) (excluido con escalón a lo ancho de todo el vehículo)	01/1995 - 05/2006	293100	Placa		340,00	2800	15,30	120	B	766008	U	7	15,00	E		
									766013	U	13	39,50	F			

Datos vehículo		Datos enganche								Datos kit eléctrico					
Sprinter Furgón (901/902/903) (distancia entre ejes 4,02m) (sin escalón + ruedas gemelas)	01/1995 - 05/2006	293200	Placa		390,00	2800	15,30	120	B	766008	U 7	15,00	E		
										766013	U 13	39,50	F		
Sprinter Furgón (3T/3,5T) (906) (distancia entre ejes 3,25m) (sin escalón + rueda simple) (con escalón y rueda simple es necesario cambiar el escalón) (excluido 4WD)	06/2006 - 05/2018	511200	Placa		275,00	3500	17,20	140	B	766107	U 7	98,00	F	•	
		511201	Mixta		395,00	3400	17,20	140	B	766113	U 13	120,00	G	•	
										727474	13	250,00	G	• • • • C E	
Sprinter Furgón (3T/3,5T/4,6T) (906) (distancia entre ejes 3,66m + 4,35m + XL) (sin escalón + rueda simple) (con escalón y rueda simple es necesario cambiar el escalón) (excluido 4WD)	06/2006 - 05/2018	511200	Placa		275,00	3500	17,20	140	B	766107	U 7	98,00	F	•	
		511201	Mixta		395,00	3400	17,20	140	B	766113	U 13	120,00	G	•	
									727474	13	250,00	G	• • • • C E		
Sprinter Furgón (3T/3,5T/4,6T) (906) (distancia entre ejes 3,66m + 4,35m + XL) (sin escalón + rueda simple) (con escalón y rueda simple es necesario cambiar el escalón) (excluido 4WD)	06/2006 - 05/2018	511300 *	Placa		305,00	3500	17,20	140	B	766107	U 7	98,00	F	•	
										766113	U 13	120,00	G	•	
										727474	13	250,00	G	• • • • C E	
Sprinter Furgón (3T/3,5T/4T/5T) (907, 910) (distancia entre ejes 3,26m + 3,66m, 3,92m y 4,32m) (511200 : sólo tracción trasera) (653800 : solo tracción delantera) (sin escalón) (excluido 4WD) (comprobar MMR)	06/2018 -	511200	Placa		275,00	3500	17,20	140	B	766107	U 7	98,00	F	•	
		653800	Placa		345,00	3500	17,20	140	B	766113	U 13	120,00	G	•	
		511201	Mixta		395,00					727664	2 13	295,00	G	• • ◦ ◦ C E	
		653801	Mixta		465,00										
Sprinter Minibus (3T/3,5T) (906) (distancia entre ejes 3,25m) (sin escalón + rueda simple) (con escalón y rueda simple es necesario cambiar el escalón) (excluido 4WD)	06/2006 - 05/2018	511200	Placa		275,00	3500	17,20	140	B	766107	U 7	98,00	F	•	
		511201	Mixta		395,00	3400	17,20	140	B	766113	U 13	120,00	G	•	
									727474	13	250,00	G	• • • • C E		





























* Hasta finalización de stock

Datos vehículo		Datos enganche								Datos kit eléctrico						
Sprinter Chasis cabina alargada (3T/3,5T) (906) (distancia entre ejes 3,25m) (rueda simple) (excluido 4WD)	06/2006 - 05/2018	511200	Placa		275,00	3500	17,20	140	B	766107	U	7	98,00	F	•	
		511201	Mixta		395,00	3400	17,20	140	B	766113	U	13	120,00	G	•	
											727474		13	250,00	G	• • • • C E
Sprinter Chasis cabina alargada (3T/3,5T/4,6T) (906) (distancia entre ejes 3,66m + 4,35m) (rueda simple) (excluido 4WD)	06/2006 - 05/2018	511200	Placa		275,00	3500	17,20	140	B	766107	U	7	98,00	F	•	
		511201	Mixta		395,00	3400	17,20	140	B	766113	U	13	120,00	G	•	
											727474		13	250,00	G	• • • • C E
Sprinter Chasis cabina alargada (5T) (906) (distancia entre ejes 3,25m + 3,66m) (rueda simple) (excluido 4WD)	06/2006 - 05/2018	511400	4F		379,00	3500	17,20	140	B	766107	U	7	98,00	F	•	
										766113	U	13	120,00	G	•	
											727474		13	250,00	G	• • • • C E
V (W638) (excluido con sensor marcha atrás)	02/1996 - 07/2003	270500	Cisne		230,00 •	2000	11,70	75	A	766107	U	7	98,00	F	•	
										766113	U	13	120,00	G	•	
V (W447) (incluido 4WD)	03/2014 -	630100	Cisne		240,00 ◦	2500	13,80	100	A	766107	U	7	98,00	F	•	
		613600	Placa		305,00 ◦	2500	13,80	100	A	766113	U	13	120,00	G	•	
		613601	Mixta		425,00 ◦	2500	13,80	100	A	727634	3	13	175,00	G	• • ◦ S C F	
		594200	BMU		450,00 ◦	2500	13,80	100	A							
Viano (W639)	09/2003 - 08/2010	419000	Cisne		220,00 ◦	2500	13,30	100	A	766107	U	7	98,00	F	•	
		419200	Placa		265,00	2500	13,30	100	A	766113	U	13	120,00	G	•	
											727454	U	13	205,00	H	• • B E
Viano (W639) (Blue Efficiency) (459000: Incluido 4WD)	09/2010 - 09/2014	459000	Cisne		220,00 ◦	2500	13,30	100	A	766107	U	7	98,00	F	•	
		050743 c	BMU		460,00 ◦	2500	14,70	100	A	766113	U	13	120,00	G	•	
											727564	3	13	205,00	H	• • • S C E
Vito (W638) (excluido con sensor marcha atrás)	02/1996 - 07/2003	270500	Cisne		230,00 •	2000	11,70	75	A	766107	U	7	98,00	F	•	
										766113	U	13	120,00	G	•	

* Hasta finalización de stock

Datos vehículo		Datos enganche								Datos kit eléctrico								
																		
Vito (W639) (hasta nº. chasis 132 224)	08/2003 - 12/2004	419000	Cisne		220,00 €	2500	13,30	100	A	766107	U	7	98,00	F	•			
		419200	Placa		265,00 €	2500	13,30	100	A	766113	U	13	120,00	G	•			
Vito (W639) (a partir nº. chasis 132 225)	01/2005 - 09/2014	459000	Cisne		220,00 €	2500	13,30	100	A	766107	U	7	98,00	F	•			
		479200	BMAh		390,00 €	2500	13,30	100	A	766113	U	13	120,00	G	•			
		050743 c	BMU		460,00 €	2500	14,70	100	A	727454	U	13	-08/2010	205,00	H	•	•	B E
Vito (W447) (incluido 4WD, Dualiner, Tourer) (excluido Pack AMG, Sport)	10/2014 -	630100	Cisne		240,00 €	2500	13,80	100	A	766107	U	7	98,00	F	•			
		613600	Placa		305,00 €	2500	13,80	100	A	766113	U	13	120,00	G	•			
		613601	Mixta		425,00 €	2500	13,80	100	A	727634	3	13		175,00	G	•	•	◦ S C F
		594200	BMU		450,00 €	2500	13,80	100	A	727564	3	13	09/2010-	205,00	H	•	•	• S C E
X (470)	09/2017 -	658300	Placa		365,00 €	3500	16,83	140	A	766107	U	7	98,00	F	•			
		658301	Mixta		485,00 €	3400	15,90	140	A	766113	U	13	120,00	G	•			
										732764		13	189,00	E	•		S B E	

Datos vehículo		Datos enganche						Datos kit eléctrico					
MITSUBISHI													
ASX (A89) (incluido 4WD)	02/2010 -	629500	Cisne		219,00	◦ 1400 8,30 70 A	766107	U 7	98,00	F •			
		531300	BMA		419,00	◦ 1400 9,61 70 A	766113	U 13	120,00	G •			
							729494	13	135,00	H • • S M N			
Colt VI 3 puertas (Z3_A,Z2_A)	01/2005 - 12/2008	408400	BMC		500,00	◦ 750 5,00 50 B	766007	U 7	13,50	E			
							766013	U 13	39,50	F			
Colt VI 5 puertas (Z3_A,Z2_A)	06/2004 - 12/2008	408500	BMC		430,00	◦ 1000 6,40 50 B	766007	U 7	13,50	E			
							766013	U 13	39,50	F			
Eclipse Cross (GK) (incluido 4WD, Adblue)	10/2017 -	644500	Cisne		220,00	◦ 2000 10,50 100 B	766107	U 7	98,00	F •			
		644600	BMU		425,00	◦ 2000 10,50 100 B	766113	U 13	120,00	G •			
							729534	13	185,00	F • • • S C E			
L200 (K6,K7) (excluido 2WD)	01/1996 - 12/2006	299400	Cisne		250,00	2700 13,80 110 A	766007	U 7	13,50	E			
							766013	U 13	39,50	F			
L200 (KA,KB) (incluido con paragolpes escalón y/o barra antiempotramiento) (excluido 2WD)	01/2004 - 08/2009	488300	Cisne		260,00	2700 14,00 115 A	766007	U 7	13,50	E			
		488400 *	Placa		300,00	2700 14,00 115 A	766013	U 13	39,50	F			
L200 (KJ,KK,KL)	07/2015 - 08/2019	604400	Placa		309,00	3100 14,80 125 A	766107	U 7	98,00	F •			
		604401	Mixta		429,00	3100 14,80 125 A	766113	U 13	120,00	G •			
							729544	13	210,00	F • • B E			
L200 (incluido Adblue)	09/2019	674500	Placa		360,00	3500 16,15 140 A	766107	U 7	98,00	F •			
		674501	Mixta		480,00	3500 16,15 140 A	766113	U 13	120,00	G •			
							729554	13	175,00	F • • • S C N			
Lancer Sportback (CX-A) (excluido 4 puertas, 4WD)	10/2007 - 12/2016	479500	Cisne		259,00	1400 8,00 70 A	766107	U 7	98,00	F •			
							766113	U 13	120,00	G •			
Montero (V2/4)	12/1990 - 04/2000	237000	Cisne		219,00	3300 15,00 135 A	766007	U 7	13,50	E •			
							766013	U 13	39,50	F •			
Montero (V80) (chasis corto)	11/2006 -	470300	Cisne		309,00	◦ 3300 16,30 140 B	766107	U 7	98,00	F •			
		470500	4F		369,00	◦ 3300 16,30 140 B	766113	U 13	120,00	G •			
		470400	BMAh		499,00	◦ 3300 16,30 140 B	729424	13	197,00	G • • C E			



































Datos vehículo		Datos enganche								Datos kit eléctrico																													
																																							
Montero (V90) (chasis largo) (excluido 3.2 Did Instyle 2010-)	11/2006 -	470300	Cisne		309,00	◦	3300	16,30	140	B	766107	U	7	98,00	F	•																							
		470500	4F		369,00	◦	3300	16,30	140	B	766113	U	13	120,00	G	•																							
		470400	BMAh		499,00	◦	3300	16,30	140	B	729424		13	197,00	G	•	•																						
Montero Sport II (KG,KH)	07/2008 -	496600 *	Placa		190,00	◦	2500	12,80	100	B	766007	U	7	13,50	E																								
											766013	U	13	39,50	F																								
Outlander Sport (CU_W) (incluido 4WD)	03/2001 - 12/2006	409000	Cisne		245,00	◦	1500	8,00	75	B	766007	U	7	13,50	E																								
Outlander (CW_W) (5 + 7 personas) (incluido 4WD)	11/2006 - 12/2012	530000	BMAh		455,00	•	2000	10,80	100	B	766107	U	7	98,00	F	•																							
											766113	U	13	120,00	G	•																							
												729432		13	135,00	F	•	•	•																				
Outlander (GG_W,GF_W) (incluido 4WD, PHEV Híbrido)	08/2012 -	567800	Cisne		228,00	•	2000	11,00	100	B	766107	U	7	98,00	F	•																							
	08/2012 - 08/2015	567900	BMAh		408,00	•	2000	11,00	100	B	766113	U	13	120,00	G	•																							
	09/2015 -	606300	BMU		458,00	•	2000	11,00	100	B	729534		13	185,00	G	•	•	•																					
Space Star (incluido 4WD)	06/1998 - 12/2004	283200	Cisne		240,00	◦	1400	7,70	75	A	766007	U	7	13,50	E																								
											766013	U	13	39,50	F																								



































* Hasta finalización de stock

Datos vehículo		Datos enganche							Datos kit eléctrico						
NISSAN															
Almera 3-5 puertas (N16)	01/2000 - 09/2006	266700	Cisne		225,00 •	1500	8,10	75	A	766007	U	7	13,50	E	
										766013	U	13	39,50	F	
Almera Tino (V10)	04/2000 - 11/2005	277000	Cisne		225,00 •	1500	8,00	75	A	766007	U	7	13,50	E	
										766013	U	13	39,50	F	
Evalia <small>(507600, incluido E-NV200)</small> <small>(507500, 531100: excluido E-NV200)</small>	07/2010 -	507500	Cisne		230,00 ◦	1100	7,00	75	A	766107	U	7	98,00	F •	
		531100	Placa		230,00 ◦	1100	7,00	75	A	766113	U	13	120,00	G •	
		507600	BMAh		410,00 ◦	1100	7,00	75	A	732624	3	13	130,00	G • • B E	
Interstart Furgón	04/2002 - 04/2010	281800	Placa		265,00	2300	14,30	100	A	766008	U	7	15,00	E	
										766013	U	13	39,50	F	
Juke 2WD (F15) <small>(excluido 4WD, Nismo)</small>	06/2010 - 11/2019	537700	BMA		415,00 ◦	1250	10,00	75	B	766107	U	7	98,00	G •	
										766113	U	13	120,00	G •	
										732654	13	-06/2014	130,00	G • • B E	
										732744	13	07/2014-	120,00	G • • S G G	
Juke (F16)	12/2019 -	680900	Cisne							766107	U	7	98,00	G •	
		681000	BMA							766113	U	13	120,00	G •	
										732834	13		175,00	G • • S B N	
Kubistart <small>(excluido 4WD)</small>	08/2003 - 03/2010	438600	Cisne		195,00	1350	7,80	75	A	766007	U	7	13,50	E	
		408600	Placa		230,00	1350	7,80	75	A	766013	U	13	39,50	F	
										742061	7		55,00	E • G G	
Micra (K12)	01/2003 - 06/2010	422300	Cisne		209,00	950	5,60	50	A	766107	U	7	98,00	F •	
										766113	U	13	120,00	G •	
Micra C+C (K12F)	08/2005 - 06/2010	422300	Cisne		209,00	950	5,60	50	A	766107	U	7	98,00	F •	
										766113	U	13	120,00	G •	
Micra (K14)	01/2017 -	650600	BMA		375,00	1170	6,60	75	A	766107	U	7	98,00	G •	
										766113	U	13	120,00	G •	
Murano (Z51)	11/2007 - 09/2014	467000	BMAh		440,00 ◦	2000	10,80	100	B	766107	U	7	98,00	F •	
										766113	U	13	120,00	G •	

Datos vehículo		Datos enganche								Datos kit eléctrico									
Navara (D22) (cabina simple, King Cab)(excluido doble cabina) (sólo 4WD)	02/1998 - 12/2004	387200	Cisne		305,00	3000	14,80	120	A	766007	U	7	13,50	E					
										766013	U	13	39,50	F					
Navara (D40) (con paragolpes escalón) (incluido 4WD)	10/2004 - 10/2015	552400	Cisne		230,00	3000	15,00	120	A	766007	U	7	13,50	E					
		581900	Placa		275,00	3500	17,20	140	A	766013	U	13	39,50	F					
											732563	7	-03/2010	80,00	E	•	G	G	
										732644	13	04/2010-	125,00	G	•	B	E		
Navara (D40) (con paragolpes tubo) (incluido 4WD)	10/2004 - 10/2015	433700 *	Cisne		245,00	3000	14,50	120	A	766007	U	7	13,50	E					
										766013	U	13	39,50	F					
											732563	7	-03/2010	80,00	E	•	G	G	
										732644	13	04/2010-	125,00	G	•	B	E		
Note (E11)	01/2006 - 07/2013	445200	Cisne		195,00	950	5,90	50	A	766107	U	7	98,00	F	•				
		445300	BMC		375,00	950	5,90	50	A	766113	U	13	120,00	G	•				
Note (E12) (581500 y 581600 : sólo Diesel, No DIG S) (587500 y 587600 : excluido Pack Sport)	06/2013 -	581500 *	Cisne		180,00	450	3,50	50	A	766107	U	7	98,00	F	•				
		587500	Cisne		209,00	450	3,50	50	A	766113	U	13	120,00	G	•				
		581600 *	BMA		330,00	450	3,50	50	A	732713	7		95,00	G	•	•	S	G	G
		587600	BMA		389,00	450	3,50	50	A										
NP300 (D22) (sólo 4WD)	04/2008 - 12/2015	387200	Cisne		305,00	3000	14,80	120	A	766007	U	7	13,50	E					
										766013	U	13	39,50	F					
NP300 Navara (D23)	12/2015 -	658300	Placa		365,00	3500	15,90	120	A	766107	U	7	98,00	F	•				
		658301	Mixta		485,00	3400	15,90	140	A	766113	U	13	120,00	G	•				
										732751	7		85,00	E	•		S	B	E
										732764	13		189,00	E	•		S	B	E
NV200 (M20) (507600, incluido E-NV200) (507500, 531100: excluido E-NV200)	02/2010 -	507500	Cisne		230,00	1100	7,00	75	A	766107	U	7	98,00	F	•				
		531100	Placa		230,00	1100	7,00	75	A	766113	U	13	120,00	G	•				
		507600	BMAh		410,00	1100	7,00	75	A	732624	3	13	130,00	G	•	•	B	E	
NV250 (X61) (incluido Adblue) (comprobar MMR)	11/2012 -	566900	Cisne		200,00	1350	8,40	75	A	766107	U	7	98,00	F	•				
		566200	Placa		270,00	1350	8,40	75	A	766113	U	13	120,00	G	•				
		566100	BMA		410,00	1350	8,40	75	A	727593	7		115,00	F	•	•	S	G	G











































* Hasta finalización de stock

Datos vehículo		Datos enganche								Datos kit eléctrico									
																			
NV300	09/2016 -	595500	Placa		232,00 •	2000	12,10	80	B	766107	U	7	98,00	F	•				
		595501	Mixta		352,00 •	2000	12,10	80	B	766113	U	13	120,00	G	•				
		573000	BMC		502,00	2000	12,10	80	B	742933		7	160,00	F	•	•	S	G	G
									742934		13	185,00	F	•	•	S	C	N	
NV400 Autobús <small>(ruedas simples y tracción delantera) (vehículos con y sin escalón)</small>	11/2011 -	532400	Placa		270,00	3000	14,30	100	B	766008	U	7	15,00	E					
										766013	U	13	39,50	F					
										742764	7	13	75,00	F		•		B	D
NV400 Furgón <small>(ruedas simples y tracción delantera) (vehículos con y sin escalón)</small>	11/2011 -	532400	Placa		270,00	3000	14,30	100	B	766008	U	7	15,00	E					
										766013	U	13	39,50	F					
										742764	7	13	75,00	F		•		M	N
NV400 Chasis Cabina <small>(ruedas simples y tracción delantera) (excluido L2 5.530 mm)</small>	11/2011 -	542800	Placa		290,00	3000	15,80	100	B	766008	U	7	15,00	E					
		542801	Mixta		410,00	3000	15,80	100	B	766013	U	13	39,50	F					
										742774	7	13	75,00	F		•		B	D
NV400 Chasis Cabina <small>(ruedas dobles y tracción trasera) (incluido L1 5.03 mm y L2 5.530 mm)</small>	11/2011 -	547400	Placa		290,00	3500	17,30	120	B	766008	U	7	15,00	E					
		547401	Mixta		410,00	3400	17,30	120	B	766013	U	13	39,50	F					
										742774	7	13	75,00	F		•		B	D
Pathfinder (R51)	01/2005 - 10/2015	557800	Cisne		160,00 ◦	3000	16,50	120	A	766007	U	7	13,50	E					
										766013	U	13	39,50	F					
										732533		7	75,00	G		•		G	G
Pixo (UA)	04/2009 - 12/2015	516400	Cisne		189,00 ◦	600	4,20	50	B	766007	U	7	13,50	E					
										766013	U	13	39,50	F					
										751313		7	70,00	F		•		G	G
Primastar	03/2001 - 04/2014	560100	Placa		239,00	2000	12,00	80	A	766007	U	7	13,50	E					
		560101	Mixta		359,00	2000	12,00	80	A	766013	U	13	39,50	F					
										742504		13	10/2006-	95,00	F		•		M
Pulsar	07/2014 -	597100	Cisne		234,00	1200	7,50	75	B	766107	U	7	98,00	F	•				
		597200	BMA		414,00	1200	7,50	75	B	766113	U	13	120,00	G	•				
										732731		7	119,00	F	•	•	S	G	G











































Datos vehículo		Datos enganche								Datos kit eléctrico									
 		       								          									
Qashqai (J10) (5 plazas)	02/2007 - 01/2014	497600	Cisne		229,00 •	1400	8,00	75	B	766107	U 7	98,00	F •						
		551900	BMA		399,00 •	1400	8,00	75	B	766113	U 13	120,00	G •						
										732583	7	95,00	F •	•	•	G	G		
										732584	13	132,00	F •	•	•	B	E		
Qashqai (J11) (incluido 4WD) (desde octubre 2018, excluido Adblue)	01/2014 -	597300	Cisne		215,00 ◦	1800	9,40	100	B	766107	U 7	98,00	F •						
		597500	BMA		405,00 ◦	1800	9,40	100	B	766113	U 13	120,00	G •						
										732713	7 -09/2019	95,00	F •	•	S	G	G		
										732714	13 -09/2019	110,00	G •	•	S	C	N		
Qashqai (J11) (incluido Adblue, 4WD) (732813, 732814, válido desde chasis SJNFFAJ11U2622271)	10/2019 -	497600	Cisne		280,00 ◦	1800	10,10	100	B	766107	U 7	98,00	F •						
		551900	BMA		460,00 ◦	1800	10,10	100	B	766113	U 13	120,00	G •						
										732813	7	90,00	F •	•	S	G	G		
										732824	13	145,00	F •	•	S	C	N		
Qashqai +2 (J10) (7 plazas)	02/2007 - 01/2014	497600	Cisne		229,00 •	1400	8,00	75	B	766107	U 7	98,00	F •						
		551900	BMA		399,00 •	1400	8,00	75	B	766113	U 13	120,00	G •						
										732583	7	95,00	F •	•	•	G	G		
										732584	13	132,00	F •	•	•	B	E		
Terrano II	02/1993 - 04/2006	310000	Cisne		173,00	3000	13,60	120	A	766007	U 7	13,50	E						
									766013	U 13	39,50	F							
X-Trail (T30)	06/2001 - 12/2007	359200	Cisne		259,00 •	2300	10,50	100	B	766007	U 7	13,50	E						
									766013	U 13	39,50	F							
X-Trail (T31)	03/2007 - 12/2013	493700	Cisne		249,00	2200	10,60	100	B	766107	U 7	98,00	F •						
		493800	BMAh		399,00	2200	11,10	100	B	766113	U 13	120,00	G •						
										732601	7	99,00	F •	•		G	G		
										732604	13	185,00	H •	•		B	E		
X-Trail (T32)	01/2014 - 02/2017	592800	BMU		460,00 ◦	2000	10,60	100	B	766107	U 7	98,00	F •						
									766113	U 13	120,00	G •							
										732723	7	99,00	F •	•	S	G	G		
										732724	13	120,00	G •	•	S	C	N		
X-Trail (T32) (incluido Adblue, apertura maletero con pie)	03/2017 -	643900	BMU		460,00 ◦	2000	10,60	100	B	766107	U 7	98,00	F •						
									766113	U 13	120,00	G •							
										732723	7	99,00	F •	•	S	G	G		
										732724	13	120,00	G •	•	S	C	N		





































* Hasta finalización de stock

Datos vehículo		Datos enganche							Datos kit eléctrico										
OPEL																			
Agila A (H00)	09/2000 - 10/2007	372700	Cisne		290,00 •	800	5,65	35	B	766007	U	7	13,50	E					
		372800	BMC		380,00 •	800	5,65	35	B	766013	U	13	39,50	F					
Agila B (H08) (sólo versión gasolina 1.2 litros)	04/2008 - 12/2015	498900	Cisne		220,00	200	4,20	50	B	766007	U	7	13,50	E					
		499000	BMAh		400,00 ◦	200	4,20	50	B	766013	U	13	39,50	F					
Antara (excluido modelos sistema Flex-Fix) (excluido Adblue)	05/2006 -	463800	Cisne		239,00	2000	11,00	80	B	766107	U	7	98,00	E	•				
		463900	BMAh		419,00 ◦	2000	11,00	80	B	766113	U	13	120,00	F	•				
										735783	5	7	75,00	F	•	•	G	G	
										735784	5	13	95,00	F	•	•	C	E	
Astra G Coupé	03/2000 - 05/2005	417300	Cisne		189,00	1500	8,50	75	A	766007	U	7	13,50	E					
									766013	U	13	39,50	F						
Astra H GTC	03/2005 - 01/2011	454000	Cisne		199,00	1650	9,50	75	A	766107	U	7	98,00	F	•				
		434100	BMA		379,00	1650	9,50	75	A	766113	U	13	120,00	G	•				
										735714	9	13	149,00	G	•	•	D	•	C
Astra G Sedán	09/1998 - 01/2007	417300	Cisne		189,00	1500	8,50	75	A	766007	U	7	13,50	E					
									766013	U	13	39,50	F						
Astra J Sedán	06/2012 -	569600	Cisne		215,00 ◦	1800	9,60	75	B	766107	U	7	98,00	F	•				
		569700	BMA		405,00 •	1800	9,60	75	B	766113	U	13	120,00	G	•				
										709574		13	180,00	G	•	•	•	•	R
Astra G 5 puertas	02/1998 - 02/2004	417300	Cisne		189,00	1500	8,50	75	A	766007	U	7	13,50	E					
									766013	U	13	39,50	F						
Astra H 5 puertas (incluido GTC) (excluido OPC, Twintop)	03/2004 - 11/2009	454000	Cisne		199,00	1650	9,50	75	A	766107	U	7	98,00	F	•				
		434100	BMA		379,00	1650	9,50	75	A	766113	U	13	120,00	G	•				
Astra J 5 puertas (excluido Flex-Fix) (excluido GTC)	12/2009 - 05/2015	526900	Cisne		220,00 ◦	1800	9,60	75	B	766107	U	7	98,00	F	•				
		527000	BMA		380,00 ◦	1800	9,60	75	B	766113	U	13	120,00	G	•				
										709574		13	180,00	G	•	•	•	•	R
Astra K 5 puertas (excluido 1.4 Ecolec, 110 KW)	06/2015 -	608100	Cisne		220,00 ◦	1800	9,90	75	B	766107	U	7	98,00	F	•				
		608200	BMA		400,00 ◦	1800	9,90	75	B	766113	U	13	120,00	G	•				
										735894		13	165,00	H	•	•	•	•	C

Datos vehículo		Datos enganche									Datos kit eléctrico																														
																																									
Astra G Break	02/1998 - 07/2004	300000	Cisne		215,00	1500	8,50	75	A	766007	U	7	13,50	E																											
											766013	U	13	39,50	F																										
Astra H Caravan (incluido GLP)	08/2004 - 09/2010	440000	Cisne		220,00	1650	9,50	75	A	766107	U	7	98,00	F	•																										
		440600	BMA		400,00	1650	9,50	75	A	766113	U	13	120,00	G	•																										
Astra J Sports Tourer (excluido sistema Flex-Flix)	10/2010 - 09/2015	569600	Cisne		215,00	1800	9,60	75	B	766107	U	7	98,00	F	•																										
		569700	BMA		405,00	1800	9,60	75	B	766113	U	13	120,00	G	•																										
											709574		13	180,00	G	•	•	•	•	•	•	•	•	•	•	•	•	•	•	•	•	•	•	•	•	•	•	•	•	R	Q
Astra K Sports Tourer (incluido CNG, apertura maletero con pie) (excluido 1.4 Ecolec, 110 KW)	10/2015 -	615800	Cisne		249,00	1550	10,00	75	B	766107	U	7	98,00	F	•																										
		615900	BMA		429,00	1550	10,00	75	B	766113	U	13	120,00	G	•																										
		677100	BMU		459,00	1550	10,00	75	B	735894		13	165,00	H	•	•	•	•	•	•	•	•	•	•	•	•	•	•	•	•	•	•	•	•	•	•	•	•	•	C	F
Combo D	02/2012 - 09/2018	526300	Cisne		209,00	1500	9,00	60	B	766107	U	7	98,00	F	•																										
		526400	BMA		389,00	1500	9,00	60	B	766113	U	13	120,00	G	•																										
											709524		13	200,00	G	•	•	•	•	•	•	•	•	•	•	•	•	•	•	•	•	•	•	•	•	•	•	•	C	N	
Combo D CNG	02/2012 - 09/2018	541200	BMA		419,00	1000	7,00	60	B	766107	U	7	98,00	G	•																										
										766113	U	13	120,00	H	•																										
											709524		13	200,00	G	•	•	•	•	•	•	•	•	•	•	•	•	•	•	•	•	•	•	•	•	•	•	•	•	C	N
Combo E (versión corta) (incluido con sensor marcha atrás) (no abre la doble puerta con el remolque enganchado)	10/2018 -	660200	Cisne		195,00	1450	8,70	74	B	766107	U	7	98,00	F	•																										
		660400	Placa		249,00	1450	8,70	74	B	766113	U	13	120,00	G	•																										
		660300	BMU		419,00	1450	8,70	74	B	738573		7	155,00	G	•	•	D	D	G	G																					
		660401	Mixta		369,00	1450	8,70	74	B	738574		13	165,00	H	•	•	D	D	C	N																					
Combo XL E (versión larga) (incluido con sensor marcha atrás) (no abre la doble puerta con el remolque enganchado)	10/2018 -	660500	Cisne		209,00	1450	8,70	74	B	766107	U	7	98,00	F	•																										
		660700	Placa		259,00	1450	8,70	74	B	766113	U	13	120,00	G	•																										
		660600	BMU		429,00	1450	8,70	74	B	738573		7	155,00	G	•	•	D	D	G	G																					
		660701	Mixta		379,00	1450	8,70	74	B	738574		13	165,00	H	•	•	D	D	C	N																					
Corsa B 3-5 puertas (comprobar MMR)	03/1993 - 08/2000	278200	Cisne		209,00	1000	5,90	50	B	766007	U	7	13,50	E																											
										766013	U	13	39,50	F																											
Corsa C 3-5 puertas (comprobar MMR)	09/2000 - 06/2006	366600	BMC		345,00	1000	6,10	50	B	766107	U	7	98,00	F	•																										
										766113	U	13	120,00	G	•																										
Corsa D 3-5 puertas (incluido ecoFlex 10-)(excluido OPC y Flex-fix) (comprobar MMR)	07/2006 - 08/2014	448800	Cisne		192,00	1300	7,50	50	B	766107	U	7	98,00	F	•																										
		448900	BMC		388,00	1300	7,50	50	B	766113	U	13	120,00	G	•																										
										735821		13	165,00	H	•	•	•	•	•	•	•	•	•	•	•	•	•	•	•	•	•	•	•	•	•	•	•	•	B	E	



















* Hasta finalización de stock

Datos vehículo		Datos enganche										Datos kit eléctrico									
 		         										          									
Corsa E 3-5 puertas (excluido OPC y Flex-fix)	09/2014 - 10/2019	448800	Cisne		192,00	◦	1300	7,50	50	B	766107	U	7	98,00	F	•					
		448900	BMC		388,00	•	1300	7,50	50	B	766113	U	13	120,00	G	•					
Corsa F 3-5 puertas (excluido OPC y Flex-fix)	07/2019 -	680800	BMAh			◦	1200	7,00	55	B	766107	U	7	98,00	F	•					
		680700	BMU			◦	1200	7,00	55	B	766113	U	13	120,00	G	•					
											709574		13	180,00	H	• • • • R Q					
Corsa Combo Furgón C	10/2001 - 01/2012	381500	Placa		249,00	•	1002	6,60	50	B	766107	U	7	98,00	F	•					
											766113	U	13	120,00	G	•					
Crossland X (incluido Adblue)	03/2017 -	649300	Cisne		230,00	◦	870	7,10	55	A	766107	U	7	98,00	F	•					
		635800	BMA		370,00	◦	870	7,10	55	A	766113	U	13	120,00	G	•					
											735914		13	160,00	G	• • D D M N					
Grandland X (incluido apertura maletero con pie) (669500, excluido con sensor marcha atrás)	06/2017 -	669500	Cisne		225,00	◦	2000	10,50	80	B	766107	U	7	98,00	F	•					
		669600	BMU		415,00	◦	2000	10,50	80	B	766113	U	13	120,00	G	•					
											738564		13	190,00	G	• • ◦ D C D					
Insignia A 4 puertas (incluido 4WD) (excluido OPC)	07/2008 - 06/2013	522200	Cisne		231,00	◦	2000	11,00	85	B	766107	U	7	98,00	F	•					
		584300	BMU		451,00	◦	2100	11,60	95	B	766113	U	13	120,00	G	•					
		492400	MX		911,00	◦	2000	10,60	85	B	709574		13	180,00	G	• • • • R Q					
Insignia A 4 puertas (incluido 4WD) (excluido OPC)	07/2013 - 06/2017	584200	Cisne		271,00		2100	11,60	95	B	766107	U	7	98,00	F	•					
		584300	BMU		451,00	◦	2100	11,60	95	B	766113	U	13	120,00	G	•					
											709574		13	180,00	G	• • • • R Q					
Insignia A 5 puertas (incluido 4WD) (excluido OPC)	07/2008 - 06/2013	522200	Cisne		231,00	◦	2000	11,00	85	B	766107	U	7	98,00	F	•					
		584300	BMU		451,00	◦	2100	11,60	95	B	766113	U	13	120,00	G	•					
		492400	MX		911,00	◦	2000	10,60	85	B	709574		13	180,00	G	• • • • R Q					
Insignia A 5 puertas (incluido 4WD) (excluido OPC)	07/2013 - 06/2017	584200	Cisne		271,00		2100	11,60	95	B	766107	U	7	98,00	F	•					
		584300	BMU		451,00	◦	2100	11,60	95	B	766113	U	13	120,00	G	•					
											709574		13	180,00	G	• • • • R Q					







































Datos vehículo		Datos enganche								Datos kit eléctrico																												
																																						
Insignia B Grand Sport 5 puertas (incluido 4WD) (excluido GSI, VXR)	07/2017 -	642200	Cisne		245,00	◦	2240	11,20	90	B	766107	U	7	98,00	F	•																						
		642300	BMU		465,00	◦	2240	11,20	90	B	766113	U	13	120,00	G	•																						
												735904		13	179,00	G	•	•	•	•	•	B	E															
Insignia A Sports Tourer (incluido 4WD, BiTurbo) (excluido OPC)	07/2008 - 06/2013	522200	Cisne		231,00	◦	2000	11,00	85	B	766107	U	7	98,00	F	•																						
		584300	BMU		451,00	◦	2100	11,60	95	B	766113	U	13	120,00	G	•																						
		522400	MX		911,00	◦	2100	11,00	85	B	709574		13	180,00	G	•	•	•	•	•	R	Q																
Insignia A Sport Tourer (incluido 4WD, BiTurbo, Country Tourer) (excluido OPC)	07/2013 - 06/2017	584200	Cisne		271,00	◦	2100	11,60	95	B	766107	U	7	98,00	F	•																						
		584300	BMU		451,00	◦	2100	11,60	95	B	766113	U	13	120,00	G	•																						
												709574		13	180,00	G	•	•	•	•	R	Q																
Insignia B Sport Tourer (incluido 4WD, apertura maletero con pie) (excluido GSI, VXR, Country Tourer)	07/2017 -	642400	Cisne		265,00	◦	2240	11,20	90	B	766107	U	7	98,00	F	•																						
		642500	BMU		465,00	◦	2240	11,20	90	B	766113	U	13	120,00	G	•																						
												735904		13	179,00	G	•	•	•	•	B	E																
Meriva A (excluido OPC)	05/2003 - 05/2010	446800	BMA		445,00	◦	1300	7,90	60	A	766107	U	7	98,00	F	•																						
											766113	U	13	120,00	F	•																						
Meriva B (incluido GLP) (excluido Flex-Fix, 1.3 CDTI) (comprobar MMR)	06/2010 - 05/2017	532700	Cisne		225,00	◦	1300	8,30	75	A	766107	U	7	98,00	F	•																						
		532800	BMA		415,00	◦	1300	8,30	75	A	766113	U	13	120,00	G	•																						
												709574		13	180,00	G	•	•	•	•	R	Q																
Mokka (incluido 4WD, GLP) (excluido sistema Flex-Flix)	06/2012 - 08/2016	566500	Cisne		215,00		1500	8,50	75	B	766107	U	7	98,00	F	•																						
		566600	BMA		395,00		1500	8,50	75	B	766113	U	13	120,00	G	•																						
												709574		13	180,00	G	•	•	•	•	R	Q																
Mokka X (incluido 4WD, GLP) (excluido sistema Flex-Flix)	09/2016 -	566500	Cisne		215,00		1500	8,50	75	B	766107	U	7	98,00	F	•																						
		566600	BMA		395,00		1500	8,50	75	B	766113	U	13	120,00	G	•																						
												709574		13	180,00	G	•	•	•	•	R	Q																
Movano A Combi (J9)	01/1999 - 04/2010	281800	Placa		265,00		2300	14,30	100	A	766008	U	7	15,00	E																							
											766013	U	13	39,50	F																							
Movano A Furgón (F9)	01/1999 - 04/2010	281800	Placa		265,00		2300	14,30	100	A	766008	U	7	15,00	E																							
											766013	U	13	39,50	F																							
Movano B Furgón (ruedas simples - tracción delantera) (para vehículos con y sin escalón) (excluido L4)	05/2010 -	532400	Placa		270,00	•	3000	14,30	100	B	766008	U	7	15,00	E																							
											766013	U	13	39,50	F																							
												742764	7	13	75,00	F				•																		



































* Hasta finalización de stock

Datos vehículo		Datos enganche								Datos kit eléctrico											
					€								€			CAN					
Movano B Chasis Cabina (ruedas simples - tracción delantera) (excluido L2 5530 mm)	05/2010 -	542800	Placa		290,00	3000	15,80	100	B	766008	U	7	15,00	E							
		542801	Mixta		410,00	3000	15,80	100	B	766013	U	13	39,50	F							
											742774	7	13	75,00	F			•			B
Movano B Chasis Cabina (ruedas dobles - tracción trasera) (incluido L1 5.030 mmy L2 5.530 mm)	05/2010 -	547400	Placa		290,00	3500	17,30	120	B	766008	U	7	15,00	E							
		547401	Mixta		410,00	3400	17,30	120	B	766013	U	13	39,50	F							
											742774	7	13	75,00	F			•			B
Signum (incluido 3,0-V6)	05/2003 - 06/2008	386400	Cisne		265,00	2000	10,70	80	B	766107	U	7	98,00	F	•						
										766113	U	13	120,00	G	•						
											735694		13	140,00	E	•			D		C
Vectra C 4 puertas (excluido OPC, VXR)	04/2002 - 08/2008	313500	Cisne		259,00	1950	10,25	78	B	766107	U	7	98,00	F	•						
										766113	U	13	120,00	G	•						
											735694		13	140,00	E	•			D		C
Vectra C 5 puertas (incluido GTS) (excluido OPC, VXR)	04/2002 - 08/2008	313500	Cisne		259,00	1950	10,25	78	B	766107	U	7	98,00	F	•						
										766113	U	13	120,00	G	•						
											735694		13	140,00	E	•			D		C
Vectra C Break (excluido OPC, VXR)	07/2003 - 08/2008	423600	Cisne		259,00	2000	10,70	80	B	766107	U	7	98,00	F	•						
		430700	BMA		429,00	2000	10,70	80	B	766113	U	13	120,00	G	•						
											735694		13	140,00	E	•			D		C
Vivaro A	08/2001 - 05/2014	560100	Placa		239,00	2000	12,00	80	A	766007	U	7	13,50	E							
		560101	Mixta		359,00	2000	12,00	80	A	766013	U	13	39,50	F							
											742504	13	10/2006-	95,00	F			•			M
Vivaro B	06/2014 - 08/2019	595500	Placa		232,00	2000	12,10	80	B	766107	U	7	98,00	F	•						
		595501	Mixta		352,00	2000	12,10	80	B	766113	U	13	120,00	G	•						
		573000	BMC		502,00	2000	12,10	80	B	742933		7	160,00	F	•			•		S	G
									742934		13	185,00	F	•			•		S	C	N



























Datos vehículo		Datos enganche								Datos kit eléctrico						
																
Vivaro C (incluido Life, L1, L2, L3) (excluido 4WD)	03/2019 -	617400	Cisne		229,00	2595	13,90	104	B	766107	U	7	98,00	F	•	
		696600	Placa		259,00	2595	13,90	104	B	766113	U	13	120,00	G	•	
		696601	Mixta		379,00	2595	13,90	104	B	738554	3	13	175,00	G	• • D D C E	
		617500	BMU		439,00	2595	13,90	104	B							
Zafira A	04/1999 - 06/2005	424300	Cisne		195,00	1600	9,30	75	A	766107	U	7	98,00	F	•	
		431500	BMA		375,00 ◦	1600	9,30	75	A	766113	U	13	120,00	G	•	
Zafira B (excluido OPC, VXR, CNG) (454400: excluido PDC original)	07/2005 - 6/2015	454400	Cisne		215,00 •	1650	9,60	75	A	766107	U	7	98,00	F	•	
		454500	BMA		415,00 •	1650	9,60	75	A	766113	U	13	120,00	G	•	
Zafira C (excluido CNG, Flex-Fix. 1.6 CDTi)	01/2017 -	552600	Cisne		222,00 ◦	1500	9,90	75	B	766107	U	7	98,00	G	•	
		552700	BMA		402,00 ◦	1500	9,90	75	B	766113	U	13	120,00	G	•	
										709574		13	180,00	G	• • • • R Q	
Zafira Tourer C (6 y 7 personas) (incluido Adblue) (excluido CNG, Flex-Fix, 1.6 CDTi)	09/2011 -	552600	Cisne		222,00 ◦	1500	9,90	75	B	766107	U	7	98,00	G	•	
		552700	BMA		402,00 ◦	1500	9,90	75	B	766113	U	13	120,00	G	•	
										709574		13	180,00	G	• • • • R Q	
Zafira Life (617400, 696600 y 696601: excluido con sensor marcha atrás) (excluido 4WD)	03/2019 -	617400	Cisne		229,00	2595	13,90	104	B	766107	U	7	98,00	F	•	
		696600	Placa		259,00	2595	13,90	104	B	766113	U	13	120,00	F	•	
		696601	Mixta		379,00	2595	13,90	104	B							
		617500	BMU		439,00	2595	13,90	104	B	738554	3	13	175,00	F	• • D D C E	

* Hasta finalización de stock







































Datos vehículo		Datos enganche							Datos kit eléctrico						
 		       							         						
PEUGEOT															
206 3-5 puertas <small>(serie XS)</small>	08/1998 - 12/2008	407000	BMC		415,00 ◦	1100	6,40	50	A	766007	U 7	13,50	E		
										766013	U 13	39,50	F		
206 3-5 puertas <small>(serie XR/XT/Gentry/ X-Line)</small>	04/2003 - 12/2008	407000	BMC		415,00 ◦	1100	6,40	50	A	766007	U 7	13,50	E		
										766013	U 13	39,50	F		
206 SW	07/2002 - 01/2007	380400	Cisne		194,00	1100	6,30	50	A	766007	U 7	13,50	E		
		380500	BMC		374,00	1100	6,30	50	A	766013	U 13	39,50	F		
206+	11/2009 - 06/2013	406900	Cisne		179,00 ◦	1100	6,40	50	A	766107	U 7	98,00	F •		
										766113	U 13	120,00	G •		
207 3-5 puertas	02/2006 - 10/2013	430900	Cisne		187,00	1203	6,70	46	A	766107	U 7	98,00	F •		
		431000	BMC		367,00 •	1203	6,70	46	A	766113	U 13	120,00	G •		
										738504	13	220,00	G • • D D B E		
207+	01/2012 - 10/2013	430900	Cisne		187,00	1203	6,70	46	A	766107	U 7	98,00	F •		
		431000	BMC		367,00 •	1203	6,70	46	A	766113	U 13	120,00	G •		
										738504	13	220,00	G • • D D B E		
207 CC	02/2007 - 10/2013	430900	Cisne		187,00	1203	6,70	46	A	766107	U 7	98,00	F •		
		431000	BMC		367,00 •	1203	6,70	46	A	766113	U 13	120,00	G •		
										738504	13	220,00	G • • D D B E		
207 SW <small>(excluido Outdoor)</small>	02/2007 - 10/2013	445400	Cisne		209,00	1280	6,70	38	A	766107	U 7	98,00	F •		
										766113	U 13	120,00	G •		
										738504	13	220,00	G • • D D B E		
208 3-5 puertas <small>(incluido GTi)</small>	03/2012 - 10/2019	556000	Cisne		188,00	1300	7,20	53	A	766107	U 7	98,00	F •		
		556100 *	BMAh		325,00	1300	7,20	53	A	766113	U 13	120,00	F •		
		628500	BMU		418,00	1150	7,00	53	A	738543	7	155,00	F • • D D G G		
										705764	13	165,00	G • • D D B E		
208 3-5 puertas <small>(incluido GT-Line) (excluido e-208)</small>	07/2012 -	680800	BMAh		◦	1200	7,00	55	B	766107	U 7	98,00	F •		
		680700	BMU		440,00 ◦	1200	7,00	55	B	766113	U 13	120,00	F •		
										738543	7	155,00	G • • ◦ ◦ G G		
307 3-5 puertas <small>(excluido Cabrio)</small>	08/2000 - 08/2007	417800	Cisne		215,00 ◦	1800	9,00	73	A	766107	U 7	98,00	F •		
		417900	BMA		395,00 ◦	1800	9,00	75	A	766113	U 13	120,00	G •		





















Datos vehículo		Datos enganche								Datos kit eléctrico																															
																																									
307 SW (360900: excluido con sensor marcha atrás)	03/2002 - 12/2009	360900	Cisne		239,00	1700	9,10	60	A	766107	U	7	98,00	G	•																										
		361000	BMC		419,00	1700	9,10	60	A	766113	U	13	120,00	G	•																										
308 I 3-5 puertas (excluido GTI)	09/2007 - 08/2013	417900	BMA		395,00	1800	9,00	75	A	766107	U	7	98,00	F	•																										
										766113	U	13	120,00	G	•																										
											738454	13	-09/2008	220,00	G	•	•	•	D	B	E																				
											738504	13	10/2008-	220,00	G	•	•	D	D	B	E																				
308 II 3-5 puertas (incluido BlueHDI) (excluido GT, GT-Line, GTI, Adblue)	09/2013 -	583400	Cisne		224,00	1600	8,40	75	B	766107	U	7	98,00	F	•																										
		583500	BMU		444,00	1600	8,40	75	B	766113	U	13	120,00	G	•																										
											705683	7		169,00	F	•	•	D	D	G	G																				
											705684	13		179,00	G	•	•	D	D	C	E																				
308 SW (497000: excluido con sensor marcha atrás)	09/2007 - 03/2014	497000	Cisne		213,00	1700	9,60	74	A	766107	U	7	98,00	F	•																										
		497100	BMA		383,00	1700	9,60	74	A	766113	U	13	120,00	G	•																										
											738454	13	-10/2008	220,00	G	•	•	•	D	B	E																				
											738504	13	11/2008-	220,00	G	•	•	D	D	B	E																				
308 SW II (incluido GT, GT-Line, Adblue)	03/2014 -	573600	Cisne		229,00	1500	8,41	71	B	766107	U	7	98,00	F	•																										
		573700	BMCv		409,00	1500	8,41	71	B	766113	U	13	120,00	G	•																										
											705683	7		169,00	F	•	•	D	D	G	G																				
											705684	13		179,00	G	•	•	D	D	C	E																				
406 (excluido Coupé)	10/1995 - 12/2000	278600	Cisne		209,00	1700	9,20	80	A	766007	U	7	13,50	E																											
										766013	U	13	39,50	E																											
406 Break	10/1996 - 10/2004	335200	Cisne		255,00	1700	9,20	80	A	766007	U	7	13,50	E																											
										766013	U	13	39,50	E																											
407 (excluido Coupé)	05/2004 - 07/2008	401500	Cisne		249,00	1900	9,55	75	A	766107	U	7	98,00	F	•																										
										766113	U	13	120,00	G	•																										
407 SW	07/2004 - 10/2010	495900	Cisne		257,00	1600	9,50	75	B	766107	U	7	98,00	F	•																										
		496100	BMA		437,00	1600	9,50	75	B	766113	U	13	120,00	G	•																										
508 I 4 puertas (incluido GT) (excluido RXH)	11/2010 - 10/2018	541400	BMA		445,00	1900	10,20	75	B	766107	U	7	98,00	F	•																										
										766113	U	13	120,00	G	•																										
											738484	13		180,00	G	•	•	•	D	C	E																				
508 II 5 puertas (incluido Adblue, GT-Line)	11/2018 -	670800	Cisne		235,00	1800	9,60	75	B	766107	U	7	98,00	F	•																										
		670900	BMU		445,00	1800	9,60	75	B	766113	U	13	120,00	G	•																										
											738594	2	13	185,00	G	•	•	•	•	M	N																				
										738584	3	13	225,00	F	•	•	•	•	C	J																					

* Hasta finalización de stock





Datos vehículo		Datos enganche							Datos kit eléctrico						
															
															
															
4007	02/2007 - 12/2012	530000	BMAh		455,00 •	2000	10,80	100	B	766107	U	7	98,00	F	•
										766113	U	13	120,00	F	•
										729432		13	135,00	F	• • • B E
4008 (629500, incluido 4WD)	05/2012 -	629500	Cisne		209,00 ◦	1400	8,30	70	A	766107	U	7	98,00	F	•
		531300	BMA		419,00 ◦	1400	9,61	70	A	766113	U	13	120,00	G	•
										729494		13	135,00	H	• • S M N
5008 I (incluido PDC, Blue Hdi)	06/2009 - 03/2017	525400	Cisne		209,00 ◦	1700	9,00	100	B	766107	U	7	98,00	F	•
		525500	BMA		430,00 •	1700	9,00	100	B	766113	U	13	120,00	G	•
										738454		13	220,00	G	• • • D B E
5008 II (incluido Adblue, GT-Line, apertura maletero con pie) (634200, excluido con sensor marcha atrás)	04/2017 -	634200	Cisne		224,00 ◦	1800	10,00	80	B	766107	U	7	98,00	F	•
		634300	BMA		404,00 ◦	1800	10,00	80	B	766113	U	13	120,00	G	•
										738564		13	190,00	G	• • ◦ D G
Bipper (incluido Tepee)	02/2008 -	498000	Cisne		215,00	1300	7,50	75	B	766107	U	7	98,00	F	•
		498100	BMAh		395,00 •	1300	7,50	75	B	766113	U	13	120,00	G	•
										709371		7	160,00	G	• G G
Boxer Furgón I (excluido 4WD)	03/1994 - 06/2006	400300	Placa		360,00	2200	13,30	120	B	766008	U	7	15,00	E	
		400301	Mixta		480,00	2200	13,30	120	B	766013	U	13	39,50	F	
Boxer Furgón II (incluido CNG) (excluido 4WD)	04/2006 -	481900	Placa		260,00 ◦	3500	17,20	140	B	766107	U	7	98,00	F	•
		481901	Mixta		380,00 ◦	3400	17,20	140	B	766113	U	13	120,00	G	•
		441800	BMAh		619,00 ◦	3000	16,83	120	B	709331		7	175,00	H	• • G G
Boxer Chasis cabina I (excluido 4WD)	03/1994 - 06/2006	400300	Placa		360,00	2200	13,30	120	B	766008	U	7	15,00	E	
		400301	Mixta		480,00	2200	13,30	120	B	766013	U	13	39,50	F	
										709401		7	140,00	F	• • • G G
Boxer Chasis cabina (excluido 4WD) (incluye ref. 9070819)	04/2006 -	481902	Placa		325,00 ◦	3500	17,20	140	C	766107	U	7	98,00	F	•
		481903	Mixta		445,00 ◦	3400	17,20	140	C	766113	U	13	120,00	G	•





















* Hasta finalización de stock

Datos vehículo		Datos enganche								Datos kit eléctrico										
 		       								          										
Expert I (excluido 4WD)	10/1995 - 12/2006	316600	Cisne		184,00	1900	10,00	80	A	766007	U	7	13,50	E						
Expert II - III (excluido 4WD)	01/2007 - 03/2016	480900	Cisne		209,00	2000	12,20	122	B	766107	U	7	98,00	F	•					
		504100	Placa		209,00	2000	12,20	122	B	766113	U	13	120,00	G	•					
		481000	BMC		389,00	2000	12,20	122	B	705673		7	169,00	F	•	•	D	D	G	G
										705674		13	179,00	H	•	•	D	D	M	G
Expert IV (incluido versión compact, media, longue, apertura maletero con pie) (617400, 696600 y 696601: excluido con sensor marcha atrás)	04/2016 -	617400	Cisne		229,00	2595	13,90	104	B	766107	U	7	98,00	F	•					
		696600	Placa		259,00	2595	13,90	104	B	766113	U	13	120,00	F	•					
		696601	Mixta		379,00	2595	13,90	104	B											
		617500	BMU		439,00	2595	13,90	104	B	738554	3	13	175,00	F	•	•	D	D	C	E
Partner I (G****)	04/1996 - 09/2002	268600	Cisne		174,00	1100	7,00	70	A	766007	U	7	13,50	E						
		455600	BMC		354,00	1100	7,00	70	A	766013	U	13	39,50	F						
Partner I (G****)	10/2002 - 03/2008	268600	Cisne		174,00	1100	7,00	70	A	766107	U	7	98,00	F	•					
		455600	BMC		354,00	1100	7,00	70	A	766113	U	13	120,00	G	•					
										705314		13	175,00	F	•	•			C	E
Partner I Origin (G****)	06/2008 - 12/2011	268600	Cisne		174,00	1100	7,00	70	A	766107	U	7	98,00	F	•					
		455600	BMC		354,00	1100	7,00	70	A	766113	U	13	120,00	G	•					
										705314		13	175,00	F	•	•			C	E
Partner II (B9,7) (versión corta) (505400, 505600: algunos vehículos excluido con sensor de marcha atrás) (incluido Tepee, Tepee Outdoor, 4WD)	04/2008 - 07/2018	505400	Cisne		195,00	1300	7,83	70	A	766107	U	7	98,00	F	•					
		505600	Placa		209,00	1300	7,83	70	A	766113	U	13	120,00	G	•					
		505500	BMAh		379,00	1300	7,83	70	A	705673		7	169,00	F	•	•	D	D	G	G
										705674		13	179,00	H	•	•	D	D	C	E







































Datos vehículo	Datos enganche		Datos kit eléctrico	
 		      	         	

PORSCHE

Cayenne (comprobar MMR) (excluido vehículos con rueda repuesto en portón)	09/2002 - 11/2017	359000	Cisne 	379,00 • 3500 16,30 140 B	766107 U 7	98,00 F •
		469100	BMA 	489,00 • 3500 16,30 140 B	766113 U 13	120,00 G •
Macan (592400, 592300: se recomienda pedir protector trasero al concesionario ref. 95B807834B1E0)	02/2014 -	592300	BMU 	570,00 • 2400 12,20 100 C	766107 U 7	98,00 F •
		592400	MX 	1.120,00 • 2400 12,20 100 C	766113 U 13	120,00 G • •
					740704 13	195,00 H • • ° ° C E































Datos vehículo		Datos enganche							Datos kit eléctrico						
															
RENAULT															
Alaskan (incluido 4WD)	12/2017 -	658300	Placa		365,00	3500	16,83	140	A	766107	U	7	98,00	F	•
		658301	Mixta		485,00	3400	15,90	140	A	766113	U	13	120,00	G	•
											732764		13	189,00	E
Captur I	06/2013 - 12/2019	589900	Cisne		185,00	1200	7,20	75	B	766107	U	7	98,00	F	•
		590000	BMC		375,00	1200	7,20	75	B	766113	U	13	120,00	G	•
										743104		13	168,00	G	• S C N
Captur II	01/2020 -	684500	Cisne		250,00	1200	8,70	80	A	766107	U	7	98,00	F	•
		684600	BMU		470,00	1200	8,70	80	A	766113	U	13	120,00	G	•
										743164	3	13	170,00	G	• S M N
Clio II (BB,CB,SB) (excluido Sport V6) (comprobar MMR)	03/1998 - 12/2004	255500	Cisne		235,00	1200	6,20	75	A	766007	U	7	13,50	E	
										766013	U	13	39,50	F	
Clio II Campus (BB,CB,SB)	01/2005 - 12/2012	255500	Cisne		235,00	1200	6,20	75	A	766007	U	7	13,50	E	
										766013	U	13	39,50	F	
Clio III (BR,CR,SR) (excluido RS/GT)	01/2005 - 12/2014	445000	Cisne		205,00	1200	7,00	75	A	766007	U	7	13,50	E	
		445100	BMA		385,00 ◦	1200	7,00	75	A	766013	U	13	39,50	F	
										742471	7	-03/2009	60,00	G	• G G
									742651	7	04/2009-	65,00	G	• S G G	
Clio IV (BH) (excluido RS, GT y GT-Line) (568400, en ocasiones la bola tapa la matrícula)	11/2012 -	568400	Cisne		205,00 •	1200	7,50	75	A	766107	U	7	98,00	F	•
		568500	BMA		390,00 •	1200	7,50	75	A	766113	U	13	120,00	G	•
										742843		7	145,00	G	• S G G
Clio V (BF) (incluido Adblue)	10/2019 -	674300	Cisne		220,00	1200	7,50	75	A	766107	U	7	98,00	F	•
		674400	BMAh		415,00 ◦	1200	7,50	75	A	766113	U	13	120,00	G	•
										743154	2	13	195,00	G	• S M N
									743164	3	13	170,00	G	• S M N	
Clio III Grand Tour (KR)	02/2008 - 12/2012	500500	Cisne		209,00	1200	7,60	75	A	766007	U	7	13,50	E	
		500600 *	BMA		349,00	1200	7,60	75	A	766013	U	13	39,50	F	
										742651		7	65,00	G	• S G G
Clio IV Sport Tourer (KH) (excluido GT)	01/2013 -	574500	Cisne		225,00	1200	7,60	75	A	766107	U	7	98,00	F	•
		574600	BMA		405,00 ◦	1200	7,60	75	A	766113	U	13	120,00	G	•
										742843		7	145,00	G	• S G G







































* Hasta finalización de stock

Datos vehículo		Datos enganche										Datos kit eléctrico									
 		        										          									
Espace III (JE)	11/1996 - 10/2002	299200	Placa		245,00 •	2100	11,70	85	A	766007	U	7	13,50	E							
										766013	U	13	39,50	E							
Espace IV (JK) (chasis corto)	11/2002 - 03/2015	327400	Cisne		265,00 ◦	2000	11,30	80	B	766007	U	7	13,50	E							
		327500	BMC		445,00 ◦	2000	11,30	80	B	766013	U	13	39,50	F							
										742362		13	92,00	G		•			B	E	
Espace V (JR) (chasis corto) (excluido apertura maletero con pie)	04/2015 -	607600	Cisne		229,00	2000	11,00	80	B	766107	U	7	98,00	F	•						
		607700	BMA		429,00 ◦	2000	11,00	80	B	766113	U	13	120,00	G	•						
		607800	MX		909,00 ◦	2000	11,00	80	B	742964		13	169,00	G	•	•	•	◦	C	E	
Grand Espace III (JE)	11/1997 - 10/2002	299200	Placa		245,00 •	2100	11,70	85	A	766007	U	7	13,50	E							
										766013	U	13	39,50	E							
Grand Espace IV (JK)	11/2002 - 12/2015	341200	Cisne		265,00	2000	11,30	80	B	766007	U	7	13,50	E							
		341300	BMC		475,00	2000	11,30	80	B	766013	U	13	39,50	F							
										742362		13	92,00	G		•			B	E	
Grand Modus (JP)	01/2008 - 12/2013	501200	Cisne		209,00	1200	6,94	75	A	766007	U	7	13,50	E							
										766013	U	13	39,50	F							
Grand Scenic II (JM)	03/2004 - 06/2009	512500	Cisne		220,00	1300	8,10	75	B	766007	U	7	13,50	E							
										766013	U	13	39,50	F							
										742412		13	110,00	G		•	•		B	G	
Grand Scenic III (JZ) (5 + 7 personas) (excluido gas)	02/2009 - 12/2016	518600	Cisne		220,00	1300	8,15	75	B	766107	U	7	98,00	F	•						
		518700	BMA		400,00	1300	8,15	75	B	766113	U	13	120,00	G	•						
										742814		13	155,00	H	•	•	•	M	N		
Grand Scenic IV (R9)	01/2017 -	620900	Cisne		220,00	1850	10,43	75	B	766107	U	7	98,00	F	•						
		621000	BMU		430,00	1850	10,43	75	B	766113	U	13	120,00	G	•						
										743014		13	-05/2018	190,00	G	•	◦	•	C	E	
										743124		13	06/2018-	190,00	G	•	◦	•	C	N	
Kadjar (incluido Adblue, 4x4)	06/2015 -	668100	Cisne		250,00	1800	10,00	85	A	766107	U	7	98,00	F	•						
		668200	BMA		460,00	1800	10,00	85	A	766113	U	13	120,00	G	•						
										742973		7	-05/2019	165,00	F	•	◦	•	G	G	
										742974		13	-05/2019	189,00	G	•	◦	•	C	E	
										743144		13	06/2019-	195,00	G	•	◦	•	C	N	



















Datos vehículo		Datos enganche									Datos kit eléctrico									
Kangoo I (FC, KC) (excluido Express, Grand volumen, 4WD)	08/1997 - 01/2008	438600	Cisne		195,00	1350	7,80	75	A	766007	U	7	13,50	E						
		408600	Placa		230,00	1350	7,80	75	A	766013	U	13	39,50	F						
											742061		7	55,00	E			•		G
Kangoo II (KW, FW) (incluido Be Bop, Express Compact, Maxi)	02/2008 - 04/2013	445700	Cisne		200,00	1350	8,50	75	A	766007	U	7	13,50	E						
		445900 *	Placa		220,00	1350	8,50	75	A	766013	U	13	39,50	F						
		445800 *	BMC		380,00	1350	8,50	75	A	742571		7	49,00	F			•		S	G
									742574		13	105,00	G			•	•	B	D	
Kangoo II Phase II (SWB / MWB / LWB) (incluido Adblue, Express Compact, Maxi) (comprobar MMR)	05/2013 -	566900	Cisne		200,00	1350	8,40	75	A	766107	U	7	98,00	F	•					
		566200	Placa		270,00	1350	8,40	75	A	766113	U	13	120,00	G	•					
		566100	BMA		410,00	1350	8,40	75	A	727593		7	115,00	F	•		•		S	G
									727594		13	135,00	F	•		•		S	B	E
Koleos I (HY) (sólo 2+4WD)	09/2008 - 07/2015	505100	Cisne		229,00	2000	12,00	100	B	766007	U	7	13,50	E						
		505200	BMA		419,00	2000	12,00	100	B	766013	U	13	39,50	F						
											742614		13	177,00	G			•		B
Koleos II (incluido Adblue, apertura maletero con el pie)	04/2017 -	643900	BMU		460,00	2000	10,50	100	B	766107	U	7	98,00	F	•					
										766113	U	13	120,00	G	•					
											743074		13	180,00	G	•		•		S
Laguna II 5 puertas (BG)	03/2001 - 12/2007	361200	Cisne		239,00	1500	8,50	75	A	766007	U	7	13,50	E						
										766013	U	13	39,50	F						
Laguna III 5 puertas (BT) (excluido Coupè, GT, 4WD)	09/2007 - 05/2016	509100	Cisne		185,00	1500	8,00	75	A	766107	U	7	98,00	F	•					
										766113	U	13	120,00	G	•					
											742554		13	215,00	G	•	•	•	•	B
Laguna II Grand Tour (KG) (361500: excluido sensor marcha atrás)	03/2001 - 12/2007	361500	Cisne		219,00	1500	8,50	75	A	766007	U	7	13,50	E						
										766013	U	13	39,50	F						
Laguna III Grand Tour (KT) (excluido GT)	10/2007 - 05/2016	509300	Cisne		195,00	1500	8,00	75	A	766107	U	7	98,00	F	•					
		448700	BMC		405,00	1500	8,00	75	A	766113	U	13	120,00	G	•					
											742564		13	225,00	G	•	•	•		B

* Hasta finalización de stock



















Datos vehículo		Datos enganche										Datos kit eléctrico																											
																																							
Master II Autobús (JD)	01/1998 - 01/2010	281800	Placa		265,00	2300	14,30	100	A	766008	U	7	15,00	E																									
										766013	U	13	39,50	F																									
Master II Furgón (FD)	01/1998 - 01/2010	281800	Placa		265,00	2300	14,30	100	A	766008	U	7	15,00	E																									
										766013	U	13	39,50	F																									
Master III Chasis Cabina (ruedas dobles - propulsión) (incluido L1 5.030 mm y L2 5.530 mm)	02/2010 -	547400	Placa		290,00	3500	17,30	120	B	766008	U	7	15,00	E																									
		547401	Mixta		410,00	3400	17,30	120	B	766013	U	13	39,50	F																									
										742774	3	13	75,00	F		•	B	D																					
Master III Chasis Cabina (ruedas simples - tracción delantera) (excluido L2 5.530 mm)	02/2010 -	542800	Placa		290,00	3000	15,80	100	B	766008	U	7	15,00	E																									
		542801	Mixta		410,00	3000	15,80	100	B	766013	U	13	39,50	F																									
										742774	3	13	75,00	F		•	B	D																					
Master III Autobús (JV) (ruedas simples - tracción delantera, con y sin escalón) (excluido L4)	02/2010 -	532400	Placa		270,00 •	3000	14,30	100	B	766008	U	7	15,00	E																									
										766013	U	13	39,50	F																									
										742764	7	13	75,00	F		•	M	N																					
Master III Furgón (FV) (ruedas simples - tracción delantera, con y sin escalón) (excluido L4)	02/2010 -	532400	Placa		270,00 •	3000	14,30	100	B	766008	U	7	15,00	E																									
										766013	U	13	39,50	F																									
										742764	3	13	75,00	F		•	M	N																					
Megane II Coupé (EM) (incluido Cabrio) (excluido con sensor marcha atrás)	09/2003 - 12/2009	426300	BMA		445,00 •	1200	7,50	75	B	766007	U	7	13,50	E																									
										766013	U	13	39,50	F																									
Megane III Coupé (DZ) (excluido GT)	11/2008 - 12/2016	512500	Cisne		220,00	1350	8,10	75	B	766107	U	7	98,00	F	•																								
		512600	BMA		400,00 ◦	1350	8,10	75	B	766113	U	13	120,00	G	•																								
										742674		13	-09/2012	230,00	H	•	•	•	S	B	D																		
										742924		13	10/2012-	140,00	G	•	•	•	•	B	E																		

Datos vehículo		Datos enganche									Datos kit eléctrico						
 		        									         						
Megane I 5 puertas (BA)	08/1995 - 12/2004	323700	Cisne		220,00	1300	7,20	65	A	766007	U	7	13,50	E			
										766013	U	13	39,50	F			
Megane II 3-5 puertas (BM/CM) (excluido RS, GT)	11/2002 - 01/2011	512500	Cisne		220,00	1350	8,10	75	B	766007	U	7	13,50	E			
		512600	BMA		400,00	1350	8,10	75	B	766013	U	13	39,50	F			
Megane III 3-5 puertas (BZ) (excluido RS, GT, Generation) (excluido Cabrio)	11/2008 - 01/2016	512500	Cisne		220,00	1350	8,10	75	B	766107	U	7	98,00	F •			
		512600	BMA		400,00	1350	8,10	75	B	766113	U	13	120,00	G •			
										742664	13	-09/2012	245,00	H • • D S B D			
										742834	13	10/2012-	150,00	H • • D S B D			
Megane IV 5 puertas (B9A) (incluido GT Line)	01/2016 -	613000	Cisne		195,00	1850	10,00	75	B	766107	U	7	98,00	F •			
		613100	BMA		375,00	1850	10,00	75	B	766113	U	13	120,00	G •			
										742994	13		175,00	G • D S C E			
Megane II Sedán (LM)	01/2003 - 10/2012	426300	BMA		445,00	1200	7,50	75	B	766007	U	7	13,50	E			
										766013	U	13	39,50	F			
Megane II Grand Tour (KM)	08/2003 - 07/2009	523100	Cisne		235,00	1300	7,80	75	B	766007	U	7	13,50	E			
		559300	BMA		415,00	1300	7,80	75	B	766013	U	13	39,50	F			
Megane III Sport Tourer (KZ) (excluido GT, GT Line) (desde 03/2012, incluido GT Line)	11/2008 - 02/2016	523100	Cisne		235,00	1500	8,00	75	B	766107	U	7	98,00	F •			
		559300	BMA		415,00	1500	8,00	75	B	766113	U	13	120,00	G •			
										742684	13	-09/2012	175,00	H • • S M G			
									742824	13	10/2012-	150,00	H • • • B E				
Megane IV Sport Tourer (K9A) (incluido GT, GT Line)	03/2016 -	619000	Cisne		240,00	1850	10,06	75	B	766107	U	7	98,00	F •			
		619100	BMU		450,00	1850	10,06	75	B	766113	U	13	120,00	G •			
										743004	13		180,00	H • • • C E			
Megane I Scenic (FA/JA) (excluido RX4)	10/1996 - 06/2000	265800	Cisne		235,00	1400	8,00	75	A	766007	U	7	13,50	E			
										766013	U	13	39,50	F			
Modus (FP/JP) (excluido vehículos preparados para portabicicletas, Grand Modus)	09/2004 - 12/2007	361800	Cisne		209,00	900	5,77	75	A	766007	U	7	13,50	E			
										766013	U	13	39,50	F			
Modus (FP/JP) (excluido vehículos preparados para portabicicletas, Grand Modus)	01/2008 - 12/2013	480100	Cisne		219,00	900	5,77	75	A	766007	U	7	13,50	E			
										766013	U	13	39,50	F			

* Hasta finalización de stock























Datos vehículo		Datos enganche							Datos kit eléctrico						
															
SAAB															
900 II Coupé	12/1993 - 02/1998	224400	Cisne		240,00 ◦	1600	8,50	75	B	766007	U	7	13,50	E	
										766013	U	13	39,50	F	
900 II 3-5 puertas	07/1993 - 02/1998	224400	Cisne		240,00 ◦	1600	8,50	75	B	766007	U	7	13,50	E	
										766013	U	13	39,50	F	
9-3 (YS3D) (excluido Cabrio)	02/1998 - 08/2003	224400	Cisne		235,00 ◦	1600	8,50	75	B	766107	U	7	98,00	F •	
										766113	U	13	120,00	G •	
9-3 Sportsedán 4 puertas (YS3F) (excluido 4WD)	09/2002 - 07/2012	377300	Cisne		265,00 •	1600	9,00	75	B	766107	U	7	98,00	F •	
		427500	BMA		455,00 ◦	1600	9,00	75	B	766113	U	13	120,00	G •	
										745024		13	145,00	E • D • C F	
9-3 Cabrio (YS3F)	08/2003 - 01/2008	377300	Cisne		265,00 •	1600	9,00	75	B	766107	U	7	98,00	F •	
		427500	BMA		455,00 ◦	1600	9,00	75	B	766113	U	13	120,00	G •	
										745024		13	145,00	E • D • C F	
9-3 Sporthatch / Sportwagon (YS3F) (excluido 4WD)	03/2005 - 07/2012	449200	Cisne		260,00 ◦	1600	9,00	75	B	766107	U	7	98,00	F •	
		449300	BMA		440,00 ◦	1600	9,00	75	B	766113	U	13	120,00	G •	
										745024		13	145,00	E • D • C F	
9-5 4 puertas (D4S/EB4) (sin regulador de nivel)	10/1998 - 12/2009	269100	Cisne		220,00 ◦	1800	9,90	75	B	766107	U	7	98,00	F •	
		269200	BMC		360,00 •	1800	9,90	75	B	766113	U	13	120,00	G •	
9-5 4 puertas (GR4) (excluido 4WD)	01/2010 - 01/2012	535900 *	Cisne		210,00 ◦	2000	11,30	85	B	766107	U	7	98,00	F •	
		536000 *	BMA		380,00 ◦	2000	11,30	85	B	766113	U	13	120,00	G •	
9-5 Break (D5S/EB5) (sin regulador de nivel)	10/1998 - 12/2009	269100	Cisne		220,00 ◦	1800	9,50	75	B	766107	U	7	98,00	F •	
		269200	BMC		360,00 •	1800	9,50	75	B	766113	U	13	120,00	G •	

* Hasta finalización de stock









































Datos vehículo		Datos enganche										Datos kit eléctrico									
																					
SEAT																					
Alhambra (7V8/7V9) (excluido con sensor marcha atrás) (Hasta el chasis Nr. 7M-Y-525000)		04/1996 - 04/2000	270200	Cisne		235,00 •	2100	11,20	85	B	766007	U	7	13,50	E	766013	U	13	39,50	F	
Alhambra (7V8/7V9) (Desde el chasis Nr. 7M-1-500001)		05/2000 - 03/2010	350000	Cisne		235,00	2100	11,20	85	B	766007	U	7	13,50	E	766013	U	13	39,50	F	
Alhambra (710/711) (incluido 4WD) (537300: vehículos 2010 - 2012 recorte visto, se incluye tapa paragolpes) (537300: vehículos 2013 - , el paragolpes lleva el recorte hecho)		06/2010 -	537200	Cisne		215,00 •	2500	12,40	100	B	766107	U	7	98,00	F •	766113	U	13	120,00	G •	
			537300	BMA		395,00 •	2500	12,40	100	B	756754		13	199,00	H • • • • B E						
Altea (446600: excluido FR, Copa) (446700: incluye tapa paragolpes, Incluido FR) (excluido Copa) (519200: excluido FR, Copa)		03/2004 - 03/2004 - 12/2009 01/2010 -	446600	Cisne		173,00 •	1600	9,10	75	B	766107	U	7	98,00	F •	766113	U	13	120,00	G •	
			446700	BMA		353,00 •	1400	8,20	75	B	746254		13	205,00	G • • ° ° C E						
			519200	BMA		353,00 •	1400	8,20	75	B											
Altea Freetrack (498800: incluido tapa paragolpes) (incluido 4WD)		01/2007 -	446600	Cisne		173,00 •	1600	9,10	75	B	766107	U	7	98,00	F •	766113	U	13	120,00	G •	
			498800 *	BMA		353,00 •	1650	9,23	75	B	746254		13	205,00	G • • ° ° C E						
Altea XL Break (excluido Copa, FR)		10/2006 - 02/2009 -	446600	Cisne		173,00 •	1600	9,10	75	B	766107	U	7	98,00	F •	766113	U	13	120,00	G •	
			519200	BMA		353,00 •	1400	8,20	75	B	746254		13	205,00	G • • ° ° C E						
Arona (incluido Adblue, FR)		09/2017 -	646800	Cisne		199,00 °	1200	7,50	60	B	766107	U	7	98,00	F •	766113	U	13	120,00	G •	
			646900	BMA		379,00 °	1200	7,50	60	B	701504	4	13	179,00	H • • ° ° C N						
Arosa		05/1997 - 06/2004	273700	Cisne		183,00 •	800	5,10	50	A	766007	U	7	13,50	E	766013	U	13	39,50	F	
Ateca (incluido apertura maletero con el pie) (excluido Cupra)		09/2016 -	623900	Cisne		209,00	2500	12,60	100	B	766107	U	7	98,00	F •	766113	U	13	120,00	G •	
			666100	BMU		459,00	2500	12,60	100	B	746304		13	185,00	H • • D ° C E						

Datos vehículo		Datos enganche										Datos kit eléctrico																							
Cordoba (6K1,6K2) <small>(sólo CLX, GLX, GTI)</small> <small>(excluido para mercado español, la bola tapa la matrícula)</small>	01/1996 - 12/1996	298800	Cisne		199,00 •	1100	6,40	50	A	766007	U	7	13,50	E	766013	U	13	39,50	F																
Cordoba (6KZ) <small>(incluido SX Coupé) (excluido para mercado español, la bola tapa la matrícula)</small>	01/1997 - 10/2002	298800	Cisne		199,00 •	1100	6,40	50	A	766007	U	7	13,50	E	766013	U	13	39,50	F																
Cordoba Vario (6K5)	08/1996 - 12/2002	298800	Cisne		199,00 •	1100	6,40	50	A	766007	U	7	13,50	E	766013	U	13	39,50	F																
Exeo	12/2008 - 12/2013	518300	Cisne		209,00 ◦	2000	10,40	80	B	766107	U	7	98,00	F •	766113	U	13	120,00	G •	746274	13	189,00	H • • •	D	C	E									
		440400	BMA		419,00 •	2000	10,40	80	B																										
Exeo ST	05/2009 - 12/2013	440400	BMA		419,00 •	2000	10,40	80	B	766107	U	7	98,00	F •	766113	U	13	120,00	G •	746274	13	189,00	H • • •	D	C	E									
Ibiza (6L1) <small>(incluido SportCoupé) (excluido FR, Cupra)</small>	02/2002 - 11/2009	366300	Cisne		185,00 •	1200	7,00	50	B	766007	U	7	13,50	E	366000	BMC		355,00 •	1200	7,00	50	B	766013	U	13	39,50	F								
Ibiza (6J/6P) <small>(incluido Sport Coupe, FR)</small> <small>(Del 2008 a 2011, excluido Sport Coupe, FR)</small> <small>(excluido CNG)</small>	03/2008 - 05/2017	533800	Cisne		192,00 ◦	1200	7,70	75	B	766107	U	7	98,00	F •	523500	BMAh		372,00 ◦	1200	7,70	75	B	766113	U	13	120,00	G •	748173	7	-05/2015	175,00	H • • ◦ ◦	G	G	
Ibiza (KJ) <small>(incluido FR)</small> <small>(comprobar MMR)</small>	05/2017 -	643400	Cisne		209,00	1200	7,10	50	A	766107	U	7	98,00	F •	643500	BMA		389,00	1200	7,10	50	A	766113	U	13	120,00	G •	701504	4	13	179,00	H • • ◦ ◦	C	N	
Ibiza ST (6J/6P)	03/2010 -	533800	Cisne		192,00 ◦	1200	7,70	75	B	766107	U	7	98,00	F •	533900	BMA		372,00 ◦	1200	7,70	75	B	766113	U	13	120,00	G •	748173	7	-05/2015	175,00	H • • ◦ ◦	G	G	
Inca Furgón	11/1995 - 06/2003	313300	Cisne		205,00 ◦	1000	6,30	75	A	766007	U	7	13,50	E	766013	U	13	39,50	F																

* Hasta finalización de stock

Datos vehículo		Datos enganche								Datos kit eléctrico							
																	
																	
																	
																	
																	
																	
																	
Tarraco	01/2019 -	666000	Cisne		239,00	2500	12,60	100	B	766107	U	7	98,00	F	•		
		666100	BMU		459,00	2500	12,60	100	B	766113	U	13	120,00	G	•		
		666400	MX		869,00	2500	12,60	100	B	701504	4	13	179,00	H	• • ° ° C N		
Toledo III (5P)	04/2004 - 05/2009	446600	Cisne		173,00 •	1600	9,10	75	B	766107	U	7	98,00	F	•		
										766113	U	13	120,00	G	•		
Toledo IV (KG)	07/2012 -	571200	Cisne		179,00 •	1300	7,80	75	B	766107	U	7	98,00	F	•		
		571300	BMA		359,00 •	1300	7,80	75	B	766113	U	13	120,00	G	•		
										748173	7	-05/2015	175,00	H	• • D D G G		
									756823	7	06/2015-	150,00	G	• • D D G G			

* Hasta finalización de stock

Datos vehículo		Datos enganche							Datos kit eléctrico						
 		      							         						
SKODA															
Fabia 4 puertas (6Y3) (excluido RS)	10/1999 - 12/2007	359500	Cisne		189,00 ◦	1200	7,10	50	B	766007	U 7	13,50	E		
		359600	BMC		369,00 ◦	1200	7,10	50	B	766013	U 13	39,50	F		
Fabia 3-5 puertas (6Y2) (excluido RS)	08/1999 - 03/2008	330900	Cisne		205,00 ◦	850	6,20	50	B	766007	U 7	13,50	E		
										766013	U 13	39,50	F		
Fabia 3-5 puertas (6Y2) (excluido RS/Montecarlo)	01/2007 - 12/2014	489000	Cisne		200,00 •	1200	7,10	50	B	766107	U 7	98,00	F •		
(625200, se aconseja cambiar el faldón del paragolpes)		625200	BMU		410,00	1200	7,10	50	B	766113	U 13	120,00	G •		
										748141	7 -05/2010	99,00	G • • G G		
										748173	7 06/2010-	175,00	H • • ◦ ◦ G G		
Fabia 5 puertas (NJ3) (excluido Montecarlo)	08/2014 -	600600	Cisne		200,00 •	1200	7,20	50	B	766107	U 7	98,00	F •		
(625200, se aconseja cambiar el faldón del paragolpes)	08/2014 - 08/2018	600700	BMA		445,00 •	1200	7,20	50	B	766113	U 13	120,00	G •		
	08/2014 - 08/2018	625200	BMU		410,00	1200	7,20	86	B	756823	7	150,00	G • • D D G G		
	09/2018 -	662700	BMU		460,00	1200	7,20	50	B						
Fabia Break (6Y5) (excluido RS/Scout)	04/2000 - 11/2007	359500	Cisne		189,00 ◦	1200	7,10	50	B	766007	U 7	13,50	E		
		359600	BMC		369,00 ◦	1200	7,10	50	B	766013	U 13	39,50	F		
Fabia Break (6Y5) (excluido RS/Scout)	12/2007 - 12/2014	359500	Cisne		189,00 ◦	1200	7,10	50	B	766107	U 7	98,00	F •		
(625200, se aconseja cambiar el faldón del paragolpes)		359600	BMC		369,00 ◦	1200	7,10	50	B	766113	U 13	120,00	G •		
		625200	BMU		410,00	1200	7,20	86	B	748141	7 -05/2010	99,00	G • • G G		
										748173	7 06/2010-	175,00	H • • ◦ ◦ G G		
Fabia Combi (NJ5) (excluido Montecarlo)	10/2014 -	600600	Cisne		200,00 •	1200	7,20	50	B	766107	U 7	98,00	F •		
(625200, se aconseja cambiar el faldón del paragolpes)	08/2014 - 08/2018	600700	BMA		445,00 •	1200	7,20	50	B	766113	U 13	120,00	G •		
	08/2014 - 08/2018	625200	BMU		410,00	1200	7,20	86	B	756823	7	150,00	G • • D D G G		
	09/2018 -	662700	BMU		460,00 ◦	1200	7,20	50	B						
Kamiq (NW4)		682700	Cisne		◦		7,30	75	A	766107	U 7	98,00	F •		
		682800	BMU		◦		7,30	75	A	766113	U 13	120,00	G •		
										701504	4 13	179,00	H • • ◦ ◦ C N		
Karoq	09/2017 -	647400	Cisne		209,00 ◦	2000	10,80	90	A	766107	U 7	98,00	F •		
		647500	BMA		389,00 ◦	2000	10,80	90	A	766113	U 13	120,00	G •		
										701504	4 13	179,00	H • • ◦ ◦ C N		

Datos vehículo		Datos enganche								Datos kit eléctrico						
Kodiaq (NS7) (incluido 4WD, apertura maletero con pie) (comprobar MMR)	01/2017 -	633400	Cisne		209,00	2300	12,40	100	B	766107	U	7	98,00	F	•	
		633500	BMA		389,00	2300	12,40	100	B	766113	U	13	120,00	G	•	
										701504	4	13	179,00	H	• • ° ° C N	
Octavia I (1U) (excluido 4WD)	09/1996 - 01/2004	524900	Cisne		170,00	1500	8,30	75	B	766007	U	7	13,50	E		
Octavia I Tour (1U) (excluido 4WD)	01/2004 - 12/2010	524900	Cisne		170,00	1500	8,30	75	B	766007	U	7	13,50	E		
Octavia II (1Z) (excluido RS, Greenline, 4WD)	02/2004 - 06/2013	451400	Cisne		187,00	1800	9,50	100	B	766107	U	7	98,00	F	•	
		452000	BMA		377,00	1800	9,50	100	B	766113	U	13	120,00	G	•	
										748164		13	205,00	G	• • ° ° C E	
Octavia III (5E) (586500, 586600: excluido RS, 4WD) (643700: sólo RS) (606500: incluido RS, excluido 4WD)	11/2012 -	586500	Cisne		209,00	1800	10,30	80	B	766107	U	7	98,00	F	•	
		643700	Cisne		209,00	1800	10,30	80	B							
		586600	BMA		389,00	1800	10,20	80	B	766113	U	13	120,00	G	•	
		606500	BMU		395,00	2000	10,30	85	B	701504	4	13	179,00	H	• • ° ° C N	
Octavia Break I (1U) (excluido 4WD)	07/1998 - 01/2004	524900	Cisne		170,00	1500	8,30	75	B	766007	U	7	13,50	E		
Octavia Break II (1Z) (excluido RS, Greenline, Scout, 4WD)	02/2004 - 06/2013	451400	Cisne		187,00	1800	9,50	100	B	766107	U	7	98,00	F	•	
		452000	BMA		377,00	1800	9,50	100	B	766113	U	13	120,00	G	•	
										748164		13	205,00	G	• • ° ° C E	
Octavia Break III (5E) (586500: incluido Greenline / excluido RS, 4WD, Scout) (643700: sólo RS, Scout) (606500: incluido RS, Greenline, Scout hasta 2016) (excluido 4WD) (586600: incluido RS, Greenline / excluido Scout, 4WD)	11/2012 -	586500	Cisne		209,00	1800	10,20	80	B	766107	U	7	98,00	F	•	
		643700	Cisne		209,00	1800	10,30	80	B	766113	U	13	120,00	G	•	
		586600	BMA		389,00	1800	10,00	80	B	701504	4	13	179,00	H	• • ° ° C N	
		606500	BMU		395,00	2000	10,30	85	B							
Rapid (NH3)	07/2012 -	571200	Cisne		179,00	1300	7,80	75	B	766107	U	7	98,00	F	•	
		571300	BMA		359,00	1300	7,80	75	B	766113	U	13	120,00	G	•	
										748173	7	-05/2015	175,00	H	• • ° ° G G	
										756823	7	06/2015-	150,00	G	• • D D G G	

* Hasta finalización de stock

Datos vehículo		Datos enganche							Datos kit eléctrico						
SMART															
Forfour	01/2004 - 06/2006	378500	BMC		399,00	750	5,00	50	A	766107	U 7	98,00	F •		
										766113	U 13	120,00	G •		
SSANGYONG															
Actyon Sports (2+4WD)	04/2007 -	623000	Placa		270,00	2300	12,27	92	A	766007	U 7	13,50	E		
										766013	U 13	39,50	F		
Korando	07/2010 - 10/2019	544700	Cisne		215,00	2000	11,55	100	A	766007	U 7 - 01/2014	13,50	E		
		544800	BMA		440,00	2000	11,55	100	A	766013	U 13 - 01/2014	39,50	F		
										766107	U 7 02/2014-	98,00	F •		
										766113	U 13 02/2014-	120,00	G •		
Korando	11/2019 -									766107	U 7	98,00	F •		
										766113	U 13	120,00	G •		
Rexton	04/2002 - 06/2006	412300	Placa		290,00	3500	14,50	140	B	766007	U 7	13,50	E		
										766013	U 13	39,50	F		
Rexton	06/2006 - 04/2013	484800	Placa		275,00	3500	15,30	140	B	766007	U 7	13,50	E		
										766013	U 13	39,50	F		
Rexton W	07/2012 - 01/2018	484800	Placa		275,00	3500	15,30	140	B	766007	U 7	13,50	E		
										766013	U 13	39,50	F		
Rexton Y4 (excluido Adblue)	02/2018 -	635100	BMA		419,00	3500	14,56	125	B	766107	U 7	98,00	F •		
										766113	U 13	120,00	G •		
Tivoli (excluido 4WD)	01/2015 - 09/2019	608000	BMA		410,00	1500	8,50	75	B	766107	U 7	98,00	F •		
										766113	U 13	120,00	G •		

* Hasta finalización de stock

Datos vehículo		Datos enganche										Datos kit eléctrico									
SUBARU																					
Forester (SF/SG) <small>(vehículos con regulación de nivel)</small> <small>(excluido 2L Turbo)</small>	03/1997 - 12/2007	402300	Cisne		270,00	2135	10,00	85	B	766007	U	7	13,50	E							
		482500	BMC		410,00	2135	10,00	85	B	766013	U	13	39,50	F							
Forester (SH)	01/2008 - 02/2013	502900	Cisne		230,00	2000	10,00	80	B	766007	U	7	13,50	E							
		503000	BMA		405,00	2000	10,00	80	B	766013	U	13	39,50	F							
Forester (SJ)	03/2013 - 10/2019	570000	Cisne		359,00	2150	10,10	80	C	766107	U	7	98,00	F	•						
		570200 *	Placa		409,00	2150	10,10	80	C	766113	U	13	120,00	G	•						
		570100	BMA		549,00	2150	10,10	80	C	750234		13	195,00	H	•	•	•	B	E		
Forester (SK)										766107	U	7	98,00	F	•						
										766113	U	13	120,00	G	•						
Impreza Sedán (GC,GD,GG) <small>(incluido WRX /STI)</small>	08/1992 - 12/2007	353400	BMC		480,00	1600	8,60	75	B	766007	U	7	13,50	E							
										766013	U	13	39,50	F							
Impreza Fastback (GR,GH,G3) <small>(excluido WRX)</small>	03/2007 - 05/2012	508600	Cisne		255,00	1600	8,70	75	B	766107	U	7	98,00	F	•						
										766113	U	13	120,00	G	•						
Impreza Break (GG,GF) <small>(incluido WRX,STI)</small>	08/1992 - 12/2007	353400	BMC		480,00	1600	8,60	75	B	766007	U	7	13,50	E							
										766013	U	13	39,50	F							
Justy III (G3X) <small>(sólo 4WD)</small>	09/2003 - 12/2006	414500	Cisne		240,00	800	5,40	50	C	766007	U	7	13,50	E							
										766013	U	13	39,50	F							
Justy IV (G3X) <small>(excluido 4WD)</small>	01/2007 - 12/2011	432300	BMC		389,00	1000	6,10	50	B	766007	U	7	13,50	E							
										766013	U	13	39,50	F							
Legacy V Sedán (BM/BR)	09/2009 -	530600	Cisne		280,00	1800	9,76	80	B	766107	U	7	98,00	F	•						
										766113	U	13	120,00	G	•						
										750214		13	135,00	G	•	•	•	B	E		
Legacy III Break (BE/BH)	10/1998 - 08/2003	329200	Cisne		255,00	1800	9,30	75	B	766007	U	7	13,50	E							
										766013	U	13	39,50	F							
Legacy IV Break (BL/BP)	09/2003 - 08/2009	466400	Cisne		309,00	2000	10,10	85	B	766007	U	7	13,50	E							
		466500	BMA		489,00	2000	10,10	85	B	766013	U	13	39,50	F							
Legacy V Break (BM/BR)	09/2009 - 02/2015	530600	Cisne		280,00	1800	9,76	80	B	766107	U	7	98,00	F	•						
										766113	U	13	120,00	G	•						





















Datos vehículo		Datos enganche										Datos kit eléctrico																											
																																							
Levorg	01/2016 -	614800	Cisne		309,00 ●	1500	9,60	90	B	766107	U	7	98,00	F	●																								
		614900	BMAh		489,00 ●	1500	9,60	90	B	766113	U	13	120,00	G	●																								
Outback (BL/BP)	09/2003 - 09/2009	466400	Cisne		309,00 ○	2000	10,10	85	B	766007	U	7	13,50	E																									
		466500	BMA		489,00 ○	2000	10,10	85	B	766013	U	13	39,50	F																									
Outback (BM/BR)	09/2009 - 02/2015	524600	Cisne		235,00 ○	2000	10,05	82	B	766107	U	7	98,00	F	●																								
		524700	BMA		415,00 ○	2000	10,05	82	B	766113	U	13	120,00	G	●																								
Outback (BS)	10/2014 -	596900	Cisne		300,00 ○	2000	10,52	90	B	766107	U	7	98,00	F	●																								
		597000	BMA		475,00 ●	2000	10,52	90	B	766113	U	13	120,00	G	●																								
Trezia	03/2011 -	539400	Cisne		220,00	850	5,60	50	B	766107	U	7	98,00	F	●																								
										766113	U	13	120,00	G	●																								
XV (GP) (incluido GLP)	12/2011 - 12/2017	554800	BMAh		450,00 ○	1600	8,93	75	B	766107	U	7	98,00	F	●																								
										766113	U	13	120,00	G	●																								
XV (GT)	01/2018 -									766107	U	7	98,00	F	●																								
										766113	U	13	120,00	G	●																								

* Hasta finalización de stock

Datos vehículo		Datos enganche										Datos kit eléctrico										
SUZUKI																						
Alto (HA25,HA35) <small>(excluido Hybrid)</small>	01/2009 -	516400	Cisne		189,00 ●	600	4,20	50	B	766007	U	7	13,50	E	766013	U	13	39,50	F			
Baleno 5P <small>(excluido Hybrid)</small>	02/2016 -	612200	Cisne		240,00 ○	1000	6,00	60	A	766007	U	7	13,50	E	766013	U	13	39,50	F			
		612300	BMAh		415,00 ○	1000	6,00	60	A	766013	U	13	39,50	F								
Celerio	03/2014 -	596400	Cisne		220,00	400	3,10	40	A	766107	U	7	98,00	F ●	766113	U	13	120,00	G ●			
		596500	BMAh		409,00	400	3,10	40	A													
Grand Vitara I 3-5 puertas (FT/GT) <small>(incluido Cabrio)</small>	03/1998 - 09/2005	435900	BMC		399,00	1800	10,00	75	A	766007	U	7	13,50	E	766013	U	13	39,50	F			
Grand Vitara XL-7 (FT/GT)	03/1998 - 09/2005	435900	BMC		399,00	1800	10,00	75	A	766007	U	7	13,50	E	766013	U	13	39,50	F			
Grand Vitara II 3 puertas (JT) <small>(con rueda recambio en el portón)</small>	04/2005 - 03/2012	440500	BMC		419,00 ●	1600	8,85	85	A	766007	U	7	13,50	E	766013	U	13	39,50	F			
										751282		13	105,00	F ●						C	E	
Grand Vitara II 3 puertas (JT)	04/2012 - 02/2015	541700 *	BMAh		419,00 ●	1600	8,85	85	A	766007	U	7	13,50	E	766013	U	13	39,50	F			
										751282		13	105,00	F ●						C	E	
Grand Vitara II 5 puertas (JT) <small>(con rueda recambio en el portón)</small>	04/2005 - 02/2015	444700	BMAh		419,00 ○	2000	10,50	85	A	766007	U	7	13,50	E	766013	U	13	39,50	G			
										751282		13	105,00	F ●						C	E	
Grand Vitara II 5 puertas (JT) <small>(sin rueda recambio en el portón)</small>	08/2010 - 02/2015	535100	Cisne		260,00 ○	2000	10,85	85	A	766007	U	7	13,50	E	766013	U	13	39,50	F			
		534900 *	BMAh		419,00 ●	2000	10,85	85	A	766013	U	13	39,50	F	751282		13	105,00	F ●		C	E
Ignis (FH) <small>(excluido 4WD)</small>	10/2000 - 12/2005	351600	Cisne		230,00	800	5,10	50	B	766007	U	7	13,50	E	766013	U	13	39,50	F			
Ignis II (MH) <small>(incluido 4WD/TSM)(excluido Sport)</small>	09/2003 - 12/2006	414500	Cisne		240,00	800	5,40	50	C	766007	U	7	13,50	E	766013	U	13	39,50	F			
Ignis III (MF) <small>(incluido Hybrid) (excluido 4WD)</small>	01/2017 -	627200	Cisne		230,00	800	5,40	50	C	766107	U	7	98,00	F ●	627300	BMAh		370,00	800	5,40	50	C
										766113	U	13	120,00	G ●								
Jimny <small>(incluido Cabrio)</small>	03/1998 - 10/2018	455900	BMC		419,00	1300	6,90	75	A	766007	U	7	13,50	E	766013	U	13	39,50	F			

Datos vehículo		Datos enganche										Datos kit eléctrico						
Jimny II (GJ)	11/2018 -	661400	Cisne		300,00	1300	6,70	75	A	766107	U	7	98,00	F	•			
		661300	BMAh		370,00	1300	6,70	75	A	766113	U	13	120,00	G	•			
Kizashi Sport (incluido 4WD)	10/2010 -	537400 *	Cisne		200,00 •	1700	9,50	75	B	766107	U	7	98,00	F	•			
										766113	U	13	120,00	G	•			
Liana Break (excluido 5 puertas, 4WD)	10/2001 - 12/2007	438700	Cisne		225,00 ◦	1200	6,90	75	C	766007	U	7	13,50	E				
										766013	U	13	39,50	F				
Splash (sólo versión gasolina 1.2 L.)	01/2008 - 12/2015	498900	Cisne		220,00	200	4,20	50	C	766007	U	7	13,50	E				
		499000	BMA		400,00 ◦	200	4,20	50	C	766013	U	13	39,50	F				
Swift III (MZ,EZ) (excluido 4WD)	02/2005 - 09/2010	484600	BMC		419,00 ◦	1000	6,00	60	B	766007	U	7	13,50	E				
										766013	U	13	39,50	F				
Swift IV (FZ,NZ) (excluido Sport/4WD)	10/2010 - 03/2017	534300	BMAh		419,00 •	1000	6,00	60	C	766007	U	7	13,50	E				
										766013	U	13	39,50	F				
Swift V (AZ) (633000: excluido 4WD) (635600: incluido 4WD)	04/2017 -	633000 *	BMA		340,00	1000	5,80	60	C	766107	U	7	98,00	F	•			
		635600	BMA		429,00	1000	5,80	60	C	766113	U	13	120,00	G	•			
SX4 (GY) (incluido 4WD)	06/2006 - 07/2013	469700	Cisne		207,00 •	1200	7,10	50	C	766007	U	7	13,50	E				
		469800	BMAh		397,00 •	1200	7,10	50	C	766013	U	13	39,50	F				
										751292		13	75,00	F	•	B E		
SX4 S-Cross	08/2013 -	580500	BMAh		419,00 ◦	1500	8,30	75	B	766107	U	7	98,00	F	•			
										766113	U	13	120,00	G	•			
										751412		13	145,00	H	•	•	C N	
Vitara 3 puertas (chasis corto)	07/1988 - 12/2005	325300	Placa		189,00	1500	8,00	75	A	766007	U	7	13,50	E				
										766013	U	13	39,50	F				
Vitara (LY)	02/2015 - 10/2018	601700	BMAh		399,00 ◦	1500	8,30	75	B	766107	U	7	98,00	F	•			
										766113	U	13	120,00	G	•			
										751412		13	145,00	H	•	•	C N	
Vitara (LY)	11/2018 -	659200	BMAh		399,00	1200	8,30	75	B	766107	U	7	98,00	F	•			
										766113	U	13	120,00	G	•			
										751412		13	145,00	H	•	•	C N	
Wagon R+ (MM)	07/2000 - 08/2008	372800	BMC		380,00 •	800	5,65	35	B	766007	U	7	13,50	E				
										766013	U	13	39,50	F				





































* Hasta finalización de stock

Datos vehículo		Datos enganche										Datos kit eléctrico									
																					
TOYOTA																					
Auris (E15) <small>(excluido hybrid)</small>	10/2006 - 09/2012	529800	Cisne		229,00	1613	8,60	60	A	766107	U	7	98,00	F	•						
		529900	BMAh		409,00	1613	8,60	60	A	766113	U	13	120,00	G	•						
Auris (E15,E18) <small>(excluido hybrid)</small>	10/2012 - 12/2018	571700	Cisne		235,00 ◦	1652	8,70	75	A	766107	U	7	98,00	F	•						
		571800	BMA		415,00 ◦	1652	8,70	75	A	766113	U	13	120,00	G	•						
										754144		13	130,00	G	•	•	S	C	E		
Auris (E18) Hybrid <small>(comprobar MMR)</small>	10/2012 - 12/2018	581000	Cisne		209,00 ◦	385	4,00	55	A	766107	U	7	98,00	F	•						
										766113	U	13	120,00	G	•						
										754144		13	130,00	G	•	•	S	C	E		
Auris Touring Sports <small>(excluido hybrid)</small>	07/2013 - 12/2018	581200	Cisne		225,00 ◦	1648	8,70	75	A	766107	U	7	98,00	F	•						
		581300	BMAh		405,00 ◦	1648	8,70	75	A	766113	U	13	120,00	G	•						
										754144		13	130,00	G	•	•	S	C	E		
Auris Touring Sports Hybrid <small>(comprobar MMR)</small>	07/2013 - 12/2018	581100	Cisne		220,00	345	3,00	55	A	766107	U	7	98,00	F	•						
										766113	U	13	120,00	G	•						
										754144		13	130,00	G	•	•	S	C	E		
Avensis Sedán (T22)	09/1997 - 02/2003	310400	Cisne		235,00 •	1400	8,30	75	A	766007	U	7	13,50	E							
										766013	U	13	39,50	F							
Avensis Sedán (T25)	04/2003 - 11/2008	438300	Cisne		245,00	1550	8,60	75	A	766007	U	7	13,50	E							
										766013	U	13	39,50	F							
Avensis Sedán (T27)	11/2008 - 11/2018	511800	Cisne		245,00	1800	10,10	75	B	766107	U	7	98,00	F	•						
		511900	BMA		425,00 •	1800	10,10	75	B	766113	U	13	120,00	G	•						
Avensis 5 puertas (T22)	09/1997 - 02/2003	310400	Cisne		235,00 •	1400	8,30	75	A	766007	U	7	13,50	E							
										766013	U	13	39,50	F							
Avensis 5 puertas (T25)	04/2003 - 11/2008	438300	Cisne		245,00	1550	8,60	75	A	766007	U	7	13,50	E							
										766013	U	13	39,50	F							
Avensis Break (T25)	04/2003 - 11/2008	442600	Cisne		300,00	1550	8,60	75	A	766007	U	7	13,50	E							
		482700	BMA		470,00 ◦	1550	8,60	75	A	766013	U	13	39,50	F							
Avensis Break (T27)	02/2009 - 11/2018	511800	Cisne		245,00	1800	10,10	75	B	766107	U	7	98,00	F	•						
		511900	BMA		425,00 •	1800	10,10	75	B	766113	U	13	120,00	G	•						



















* Hasta finalización de stock

Datos vehículo		Datos enganche									Datos kit eléctrico					
Corolla Verso (E12)	09/2001 - 05/2004	363700	Cisne		235,00	1400	8,20	55	A	766007	U	7	13,50	E		
										766013	U	13	39,50	F		
Corolla Verso (R1)	03/2004 - 04/2009	443700	Cisne		229,00 •	1450	8,60	60	B	766007	U	7	13,50	E		
		443800	BMC		419,00 •	1400	8,60	60	B	766013	U	13	39,50	F		
Hi-Ace IV (H1,H2) (incluido 4WD) (chasis corto y largo)	08/1995 - 12/2008	283100	Cisne		279,00	2000	11,90	75	A	766007	U	7	13,50	E		
		537100	Placa		259,00	2000	12,10	80	A	766013	U	13	39,50	F		
Hi-Lux (N25/N26) (con paragolpes trasero y sin barra antiempotramiento) (pedir barra antiempotramiento 9070086)	11/2004 - 12/2010	408100 *	Placa		225,00	2800	13,80	120	B	766007	U	7	13,50	E		
		9070086			275,00					766013	U	13	39,50	F		
Hi-Lux (N25/N26) (sin paragolpes trasero y sin barra antiempotramiento) (pedir barra antiempotramiento 9070086)	11/2004 - 12/2010	408200 *	Placa		225,00	2800	13,80	120	B	766007	U	7	13,50	E		
		9070086			275,00					766013	U	13	39,50	F		
Hi-Lux (N25/26) (vehículos con barra antiempotramiento)	07/2011 - 05/2016	522100	Placa		185,00	2858	14,40	120	A	766007	U	7	13,50	E		
		522101	Mixta		305,00	2858	14,40	120	A	766013	U	13	39,50	F		
Hi-Lux (N12/N13)	02/2016 -	608300	Placa		284,00	3500	17,20	140	A	766107	U	7	98,00	F		
		608301	Mixta		404,00	3400	17,20	140	A	766113	U	13	120,00	G		
										754174		13	265,00	H • • B E		
Land Cruiser 3-5 puertas (J95/J90)	04/1995 - 12/2002	330100	4F		380,00	3500	14,70	140	A	766007	U	7	13,50	E		
										766013	U	13	39,50	F		
Land Cruiser 120 5 puertas (J120)	09/2002 - 12/2010	410400	Cisne		215,00 •	3500	16,30	140	B	766007	U	7	13,50	E		
										766013	U	13	39,50	F		
Land Cruiser V8 (J200)	08/2007 -	424500	Cisne		209,00 ◦	3500	17,40	140	B	766107	U	7	98,00	F •		
		424600	Placa		235,00 ◦	3500	17,40	140	B	766113	U	13	120,00	G •		
		424700	BMA		445,00 ◦	3500	17,40	140	B	753974		13	145,00	G • • C E		
Land Cruiser 150 3-5 puertas (J155/J150)	08/2009 -	526000	Cisne		199,00 •	3500	15,80	120	B	766107	U	7	98,00	F •		
		526100	BMA		399,00 •	3500	15,80	120	B	766113	U	13	120,00	G •		
										754054		13	185,00	G • • C E		















* Hasta finalización de stock





























Datos vehículo		Datos enganche								Datos kit eléctrico																													
																																							
RAV 4 IV (A4/XA3) (incluido PHEV Hybrid) (excluido apertura maletero con el pie)	12/2012 - 01/2019	570300	Cisne		359,00	•	2225	10,90	80	C	766107	U	7	98,00	F	•																							
		570400	BMAh		569,00	•	2225	10,90	80	C	766113	U	13	120,00	G	•																							
RAV 4 V (A5) (incluido Hybrid, 4WD) (el sistema de apertura maletero con el pie no funciona al instalar el enganche)	02/2019 -	663300	Cisne		339,00	•	2000	10,90	80	B	766107	U	7	98,00	F	•																							
		663400	BMAh		519,00	•	2225	10,90	80	B	766113	U	13	120,00	G	•																							
Verso (R1)	01/2007 - 04/2009	443700	Cisne		229,00	•	1450	8,60	60	B	766007	U	7	13,50	E																								
		443800	BMC		419,00	•	1400	8,60	60	B	766013	U	13	39,50	F																								
Verso (R2)	04/2009 -	565700	Cisne		240,00		1500	9,30	60	B	766107	U	7	98,00	F	•																							
		565800	BMAh		430,00		1500	9,30	60	B	766113	U	13	120,00	G	•																							
Yaris (P1)	01/1999 - 12/2005	388900	Cisne		240,00		900	6,00	50	B	766007	U	7	13,50	E																								
											766013	U	13	39,50	F																								
Yaris (P9) (excluido TS)	08/2005 - 11/2010	465400	Cisne		225,00		1260	6,80	50	B	766007	U	7	13,50	E																								
		465500	BMAh		395,00		1260	6,80	50	B	766013	U	13	39,50	F																								
Yaris (P13) (excluido Hybrid)	12/2010 - 10/2013	592100	Cisne		215,00		1050	6,50	50	A	766007	U	7	13,50	E																								
		548100 *	BMAh		320,00		1050	6,50	50	A	766013	U	13	39,50	F																								
		592200	BMAh		415,00		1050	6,50	50	A																													
Yaris (P13) (excluido Hybrid)	10/2013 -	592100	Cisne		215,00		1050	6,50	50	A	766107	U	7	98,00	F	•																							
		592200	BMAh		415,00	◦	1050	6,50	50	A	766113	U	13	120,00	G	•																							
Yaris Verso (P20)	08/1999 - 09/2005	301900	BMC		395,00		1000	6,30	50	B	766007	U	7	13,50	E																								
											766013	U	13	39,50	F																								

* Hasta finalización de stock

Datos vehículo	Datos enganche	Datos kit eléctrico
 	      	         

VOLKSWAGEN

Amarok (para vehículos con paragolpes escalón) (incluido 4WD & V6)	09/2010 -	537900	Cisne 	153,00	3200 16,40 120 A	766107	U 7	98,00 F •
		613200	Placa 	179,00	3200 16,40 140 A	766113	U 13	120,00 G •
		613201	Mixta 	299,00	3200 16,40 140 A	756764	13	250,00 G • • • • C E
Bora 4 puertas (excluido 4WD)	10/1998 - 09/2005	524900	Cisne 	170,00 ◦	1500 8,30 75 A	766007	U 7	13,50 E
						766013	U 13	39,50 F
Bora Variant (excluido 4WD)	05/1999 - 05/2005	261300	Cisne 	229,00 •	1500 8,30 75 A	766007	U 7	13,50 E
						766013	U 13	39,50 F
Caddy II	11/1995 - 01/2004	313300	Cisne 	205,00 ◦	1000 6,30 75 A	766007	U 7	13,50 E
						766013	U 13	39,50 F
Caddy III (incluido 4 motion, Life) (excluido EcoFuel, GLP, Maxi, Cross) (comprobar MMR)	03/2004 - 04/2015	577000	Cisne 	259,00	1500 9,40 80 A	766107	U 7	98,00 F •
		577100	BMA 	460,00	1500 9,40 80 A	766113	U 13	120,00 G •
						756594	13	195,00 H • • D D C N
Caddy IV (577000: incluido 4 motion, Life) (excluido EcoFuel, GLP, Maxi, Cross, Alltrack)(606100: incluido 4 motion, Life, Maxi) (excluido EcoFuel, GLP, Cross, Alltrack)(comprobar MMR)	05/2015 -	577000	Cisne 	259,00	1500 9,40 80 A	766107	U 7	98,00 F •
		606100	BMU 	475,00 ◦	1500 9,40 80 A	766113	U 13	120,00 G •
						756594	13	195,00 H • • D D C E
Caddy V (SBB / SBJ)	12/2020 -							
CC Coupé (incluido 4 motion)	11/2011 -	539000	Cisne 	209,00 ◦	2200 11,30 90 B	766107	U 7	98,00 F •
		558200	BMA 	389,00 ◦	2200 11,30 90 B	766113	U 13	120,00 G •
						756574	13	205,00 G • • • • C N
Crafter Furgón (3T/3,5T) (distancia entre ejes 3,25m) (sin escalón + rueda simple) (con escalón y rueda simple es necesario cambiar el escalón) (excluido 4WD)	04/2006 - 03/2017	511200	Placa 	275,00	3500 17,20 140 B	766107	U 7	98,00 F •
		511201	Mixta 	395,00	3400 17,20 140 B	766113	U 13	120,00 G •
						727474	13	250,00 G • • • • C E









































Datos vehículo		Datos enganche										Datos kit eléctrico													
																									
Crafter Furgón (3T/3,5T/4,6T) (distancia entre ejes 3,66m + 4,35m + XL) (sin escalón + rueda simple) (con escalón y rueda simple es necesario cambiar el escalón) (excluido 4WD)	04/2006 - 03/2017	511200	Placa		275,00	3500	17,20	140	B	766107	U	7	98,00	F	•										
		511201	Mixta		395,00	3400	17,20	140	B	766113	U	13	120,00	G	•										
											727474		13	250,00	G	•	•	•	•	C	E				
Crafter Furgón (3T/3,5T/4,6T) (distancia entre ejes 3,66m + 4,35m + XL) (sin escalón + rueda simple) (con escalón y rueda simple es necesario cambiar el escalón) (excluido 4WD)(excluido sensor aproximación trasero)	04/2006 - 03/2017	511300 *	Placa		305,00	3500	17,20	140	B	766107	U	7	98,00	F	•										
										766113	U	13	120,00	G	•										
											727474		13	250,00	G	•	•	•	•	C	E				
Crafter Furgón (SY) (633200, sin escalón) (645100, con escalón) (excluido 4WD y ruedas gemelas) (excluido sensor aproximación trasera)	04/2017 -	633200	Placa		295,00	3500	17,50	150	B	766107	U	7	98,00	F	•										
		645100	Placa		375,00	3500	17,50	150	B	766113	U	13	120,00	G	•										
		633201	Mixta		415,00	3400	17,50	150	B	756874	3	13	80,00	F	•		•	•	C	G					
		645101	Mixta		495,00	3400	17,50	150	B	756884	2	13	245,00	G	•	•	◦	◦	C	F					
Crafter Minibus (3T/3,5T) (distancia entre ejes 3,25m) (con y sin escalón) (rueda simple)	04/2006 - 03/2017	511200	Placa		275,00	3500	17,20	140	B	766107	U	7	98,00	F	•										
		511201	Mixta		395,00	3400	17,20	140	B	766113	U	13	120,00	G	•										
											727474		13	250,00	G	•	•	•	•	C	E				
Crafter Minibus (3T/3,5T/4,6T) (distancia entre ejes 3,66m + 4,35m + XL) (sin escalón + rueda simple) (excluido 4WD)	04/2006 - 03/2017	511200	Placa		275,00	3500	17,20	140	B	766107	U	7	98,00	F	•										
		511201	Mixta		395,00	3400	17,20	140	B	766113	U	13	120,00	G	•										
											727474		13	250,00	G	•	•	•	•	C	E				
Crafter Minibus (3T/3,5T/4,6T) (distancia entre ejes 3,66m + 4,35m + XL) (sin escalón + rueda simple) (con escalón y rueda simple es necesario cambiar el escalón) (excluido 4WD)	04/2006 - 03/2017	511300 *	Placa		305,00	3500	17,20	140	B	766107	U	7	98,00	F	•										
										766113	U	13	120,00	G	•										
											727474		13	250,00	G	•	•	•	•	C	E				
Crafter Minibus (SY) (633200, sin escalón) (645100, con escalón) (excluido 4WD y ruedas gemelas)	04/2017 -	633200	Placa		295,00	3500	17,50	150	B	766107	U	7	98,00	F	•										
		645100	Placa		375,00	3500	17,50	150	B	766113	U	13	120,00	G	•										
		633201	Mixta		415,00	3400	17,50	150	B	756874	3	13	80,00	F	•		•	•	C	G					
		645101	Mixta		495,00	3400	17,50	150	B	756884	2	13	245,00	G	•	•	◦	◦	C	F					

* Hasta finalización de stock

Datos vehículo		Datos enganche								Datos kit eléctrico							
Crafter Chasis cabina (3T/3,5T) <small>(distancia entre ejes 3,25m)(rueda simple)</small> <small>(excluido 4WD)</small>	04/2006 - 03/2017	511200	Placa		275,00	3500	17,20	140	B	766107	U	7	98,00	F	•		
		511201	Mixta		395,00	3400	17,20	140	B	766113	U	13	120,00	G	•		
											727474		13	250,00	G	• • • • C E	
Crafter Chasis cabina (3T/3,5T/4,6T) <small>(distancia entre ejes 3,66m + 4,35m) (rueda simple)</small> <small>(excluido 4WD)</small>	04/2006 - 03/2017	511200	Placa		275,00	3500	17,20	140	B	766107	U	7	98,00	F	•		
		511201	Mixta		395,00	3400	17,20	140	B	766113	U	13	120,00	G	•		
											727474		13	250,00	G	• • • • C E	
Crafter Chasis cabina (5T) <small>(distancia entre ejes 3,25m + 3,66m) (rueda simple)</small> <small>(excluido 4WD)</small>	04/2006 - 03/2017	511400	4F		379,00	3500	17,20	140	B	766107	U	7	98,00	F	•		
										766113	U	13	120,00	G	•		
											727474		13	250,00	G	• • • • C E	
Crafter Chasis cabina alargada (3T/3,5T) <small>(distancia entre ejes 3,25m)(rueda simple)</small> <small>(excluido 4WD)</small>	04/2006 - 03/2017	511200	Placa		275,00	3500	17,20	140	B	766107	U	7	98,00	F	•		
		511201	Mixta		395,00	3400	17,20	140	B	766113	U	13	120,00	G	•		
											727474		13	250,00	G	• • • • C E	
Crafter Chasis cabina alargada (3T/3,5T/4,6T) <small>(distancia entre ejes 3,66m + 4,35m) (rueda simple)</small> <small>(excluido 4WD)</small>	04/2006 - 03/2017	511200	Placa		275,00	3500	17,20	140	B	766107	U	7	98,00	F	•		
		511201	Mixta		395,00	3400	17,20	140	B	766113	U	13	120,00	G	•		
											727474		13	250,00	G	• • • • C E	
Crafter Chasis cabina alargada (5T) <small>(distancia entre ejes 3,25m + 3,66m) (rueda simple)</small> <small>(excluido 4WD)</small>	04/2006 - 03/2017	511400	4F		379,00	3500	17,20	140	B	766107	U	7	98,00	F	•		
										766113	U	13	120,00	G	•		
											727474		13	250,00	G	• • • • C E	
Fox <small>(comprobar MMR)</small>	10/2003 - 12/2011	478900	Cisne		205,00°	1000	6,70	50	A	766007	U	7	13,50	E			
										766013	U	13	39,50	F			
Golf Alltrack (BA5)	01/2015 -	586500	Cisne		209,00 •	1800	10,20	80	B	766107	U	7	98,00	F	•		
		586600	BMA		389,00 •	1800	10,20	80	B	766113	U	13	120,00	G	•		
										701504	4	13	179,00	H	• • ° ° C N		
Golf III Cabrio (1E7)	07/1993 - 05/1998	200400	Cisne		214,00 •	1500	8,30	75	A	766007	U	7	13,50	E			
										766013	U	13	39,50	F			
Golf III 3-5 puertas (1H1) <small>(incluido Synchro)</small>	08/1991 - 07/1998	200400	Cisne		214,00 •	1500	8,30	75	A	766007	U	7	13,50	E			
										766013	U	13	39,50	F			
Golf IV 3-5 puertas (1J1) <small>(excluido 4Motion, R32)</small>	08/1997 - 06/2005	524900	Cisne		170,00 °	1500	8,30	75	A	766007	U	7	13,50	E			
										766013	U	13	39,50	F			









































Datos vehículo		Datos enganche								Datos kit eléctrico						
Golf V 3-5 puertas (1K1) (218500: incluido 4Motion / excluido GT Sport) (427600: incluido 4Motion / excluido GTI, R32) (427600: incluye tapa de paragolpes)	10/2003 - 02/2009	518500	Cisne		179,00 •	1800	9,40	100	B	766107	U	7	98,00	F	•	
		427600	BMA		369,00 •	1800	9,70	75	B	766113	U	13	120,00	G	•	
											756674		13	204,00	G	• • ◦ ◦ C N
Golf VI 3-5 puertas (1K,5K1) (incluido BlueMotion, 4Motion) (excluido R-Line) (515100: pedir al concesionario spoiler y tapa paragolpes)	10/2008 - 11/2013	518500	Cisne		179,00 •	1800	9,40	100	B	766107	U	7	98,00	F	•	
		491700	BMAh		369,00 •	1700	9,40	100	B	766113	U	13	120,00	G	•	
		515100	BMA		369,00 •	1700	9,40	100	B	756674		13	204,00	G	• • ◦ ◦ C N	
Golf VII 3-5 puertas (5G1, BE1) (567000: incluido GTE Hybrid / excluido GTI, R-Line, R4 motion, e-Golf) (567100: excluido GTI, R-Line, R 4Motion, e-Golf) (586600: sólo GTE Hybrid / excluido e-Golf) (606500: incluido GTI, si es GTI en algunos casos es necesario cambiar paragolpes / excluido e-Golf) (Dependiendo del año y modelo no es necesario recortar el paragolpes)	08/2012 -	567000	Cisne		180,00 •	2000	9,90	80	B	766107	U	7	98,00	F	•	
		567100	BMA		390,00 •	2000	9,90	80	B	766113	U	13	120,00	G	•	
		586600	BMA		389,00 ◦	1800	10,20	80	B	701504	4	13	179,00	H	• • ◦ ◦ C N	
		606500	BMU		395,00 ◦	2000	10,30	85	B							
Golf VIII 3-5 puertas	01/2020 -	696800	Cisne		190,00	2000	10,30	85	B	766107	U	7	98,00	F	•	
		687000	BMA		380,00	2000	10,30	85	B	766113	U	13	120,00	G	•	
		687100	BMU		440,00	2000	10,30	85	B	701504	4	13	179,00	H	• • ◦ ◦ C N	
Golf III Variant (1H5) (incluido Synchro)	07/1993 - 04/1999	220400	Cisne		225,00 •	1500	8,30	75	A	766007	U	7	13,50	E		
										766013	U	13	39,50	F		
Golf IV Variant (1J5) (excluido 4Motion)	05/1999 - 06/2006	261300	Cisne		229,00 •	1500	8,30	75	A	766007	U	7	13,50	E		
										766013	U	13	39,50	F		
Golf V Variant (1K5) (incluido 4 motion) (450300: incluido tapa paragolpes) (527200: pedir al concesionario spoiler y tapa paragolpes)	06/2007 - 07/2009	450200	Cisne		193,00 •	1700	9,30	75	B	766107	U	7	98,00	F	•	
		450300	BMA		373,00 ◦	1700	9,30	75	B	766113	U	13	120,00	G	•	
		527200	BMA		373,00	1800	9,30	100	B	756674		13	204,00	G	• • ◦ ◦ C E	
Golf VI Variant (1K, AJ5) (incluido BlueMotion, 4 motion) (527200: pedir al concesionario spoiler y tapa paragolpes)	07/2009 - 07/2013	450200	Cisne		193,00 •	1700	9,30	75	B	766107	U	7	98,00	F	•	
		527200	BMA		373,00	1800	9,00	100	B	766113	U	13	120,00	G	•	
									756674		13	204,00	G	• • ◦ ◦ C N		

* Hasta finalización de stock

Datos vehículo		Datos enganche								Datos kit eléctrico											
																					
Golf VII Variant (BA5) (incluido 4 motion, Alltrack) (excluido R-Line) (Dependiendo del vehículo el recorte del paragolpes es no visto)	04/2013 -	586500	Cisne		209,00	1800	10,20	80	B	766107	U	7	98,00	F	•						
		586600	BMA		389,00	1800	10,20	80	B	766113	U	13	120,00	G	•						
		633900	BMU		419,00	1800	10,20	80	B	701504	4	13	179,00	H	•	•	◦	◦	C	N	
Golf VIII Variant (CG5)			Cisne							766107	U	7	98,00	F	•						
			BMU							766113	U	13	120,00	G	•						
Golf V Plus (5M) (incluido BlueMotion) (427600: incluido tapa paragolpes) (hasta chasis 1K-9-899999)	01/2005 - 01/2009	518500	Cisne		179,00	1800	9,40	100	B	766107	U	7	98,00	F	•						
		427600	BMA		369,00	1800	9,70	75	B	766113	U	13	120,00	G	•						
										756674		13	204,00	G	•	•	◦	◦	C	N	
Golf VI Plus (incluido BlueMotion) (515100: pedir al concesionario spoiler y tapa paragolpes)	02/2009 - 12/2013	518500	Cisne		179,00	1800	9,40	100	B	766107	U	7	98,00	F	•						
		491700	BMAh		369,00	1700	9,40	100	B	766113	U	13	120,00	G	•						
		515100	BMA		369,00	1700	9,40	100	B	756674		13	204,00	G	•	•	◦	◦	C	E	
Golf VII Sportsvan (Dependiendo del vehículo el recorte del paragolpes es no visto)	04/2013 -	586500	Cisne		209,00	1800	10,20	80	B	766107	U	7	98,00	F	•						
		586600	BMA		389,00	1800	10,20	80	B	766113	U	13	120,00	G	•						
		606500	BMU		395,00	2000	10,30	85	B	701504	4	13	179,00	H	•	•	◦	◦	C	N	
Jetta III (1K2) (450300: incluido tapa paragolpes) (527200 , pedir al concesionario spoiler y tapa parag.)	08/2005 - 10/2010	450200	Cisne		193,00	1700	9,30	75	B	766107	U	7	98,00	F	•						
		450300	BMA		373,00	1700	9,30	75	B	766113	U	13	120,00	G	•						
		527200	BMA		373,00	1800	9,30	100	B	756574		13	205,00	G	•	•	◦	◦	C	E	
Jetta IV (162,163) (excluido Hybrid)	04/2010 -	541000	Cisne		179,00	1500	9,00	75	B	766107	U	7	98,00	F	•						
										766113	U	13	120,00	G	•						
										756574		13	205,00	G	•	•	◦	◦	C	N	
LT 28 Furgón (distancia entre ejes 3,0 m) (sin escalón)	04/1996 - 07/2006	293100	Placa		340,00	2800	15,30	120	A	766008	U	7	15,00	E							
										766013	U	13	39,50	F							
LT 28 Furgón (distancia entre ejes 3,55m + 4,02m) (sin escalón + ruedas simples)	04/1996 - 07/2006	293200	Placa		390,00	2800	15,30	120	A	766008	U	7	15,00	E							
										766013	U	13	39,50	F							
LT 28 Furgón (distancia entre ejes 3,5m + 4,02m) (excluido con escalón a lo ancho de todo el vehículo)	04/1996 - 07/2006	293100	Placa		340,00	2800	15,30	120	A	766008	U	7	15,00	E							
										766013	U	13	39,50	F							

Datos vehículo		Datos enganche									Datos kit eléctrico										
LT 35 Furgón (distancia entre ejes 3,0 m) (sin escalón)	04/1996 - 07/2006	293100	Placa		340,00	2800	15,30	120	A		766008	U	7	15,00	E						
											766013	U	13	39,50	F						
LT 35 Furgón (distancia entre ejes 3,55m + 4,02m) (sin escalón + ruedas simples)	04/1996 - 07/2006	293200	Placa		390,00	2800	15,30	120	A		766008	U	7	15,00	E						
											766013	U	13	39,50	F						
LT 35 Furgón (distancia entre ejes 3,5m + 4,02m) (excluido con escalón a lo ancho de todo el vehículo)	04/1996 - 07/2006	293100	Placa		340,00	2800	15,30	120	A		766008	U	7	15,00	E						
											766013	U	13	39,50	F						
LT 46 Furgón (distancia entre ejes 4,02m) (sin escalón + ruedas gemelas)	04/1996 - 07/2006	293200	Placa		390,00	2800	15,30	120	A		766008	U	7	15,00	E						
											766013	U	13	39,50	F						
Lupo (excluido 16V/3L)	09/1998 - 07/2005	273700	Cisne		183,00 •	800	5,10	50	A		766007	U	7	13,50	E						
											766013	U	13	39,50	F						
Passat Berlina (3B) (excluido 4Motion)	08/1996 - 05/2005	405000	Cisne		215,00	2000	10,30	85	A		766007	U	7	13,50	E						
		432400	BMA		395,00 •	2000	10,30	85	A		766013	U	13	39,50	F						
Passat Berlina Synchro (3B)	08/1996 - 05/2005	285000	BMC		479,00 °	2000	10,30	85	B		766007	U	7	13,50	E	•					
											766013	U	13	39,50	F	•					
Passat Berlina (3C) (incluido 4Motion, BlueMotion) (450600: incluido tapa paragolpes)	03/2005 - 11/2010	450500	Cisne		185,00 •	2200	11,30	85	B		766107	U	7	98,00	F	•					
		450600	BMA		375,00 •	2200	11,30	85	B		766113	U	13	120,00	G	•					
											756574		13	205,00	G	•	•	°	°	C	N
Passat Berlina (3C) (incluido Ecofuel) (excluido 4Motion)	10/2010 - 12/2014	539000	Cisne		209,00 °	2200	11,30	90	B		766107	U	7	98,00	F	•					
		558200	BMA		389,00 °	2200	11,30	90	B		766113	U	13	120,00	G	•					
											756574		13	205,00	G	•	•	°	°	C	N
Passat Berlina (3C) (598400: incluido Adblue, GTE Hybrid, R-Line, apertura maletero con pie) (excluido 4 Motion) (598500: incluido Adblue, GTE Hybrid, R-Line, apertura maletero con pie 4 motion) (614700: incluido GTE Hybrid, R-Line, apertura maletero con pie, 4 motion)	08/2014 -	598400	Cisne		215,00 °	2200	11,30	90	B		766107	U	7	98,00	F	•					
		598500	BMA		395,00 °	2200	11,30	90	B		766113	U	13	120,00	G	•					
		614700	BMU		449,00 °	2201	12,30	90	B		701504	4	13	179,00	H	•	•	°	°	C	N

* Hasta finalización de stock

Datos vehículo		Datos enganche								Datos kit eléctrico											
																					
Touareg (7P) (excluido vehículos con rueda repuesto en el portón)	05/2010 - 05/2018	449000	Cisne		379,00 •	3500	16,30	140	B	766107	U	7	98,00	F	•						
		469100	BMA		489,00 •	3500	16,30	140	B	766113	U	13	120,00	G	•						
Touareg (CR7) (incluido apertura maletero con pie)	06/2018 -	660100	Cisne		480,00 ◦	3500	16,40	140	B	766107	U	7	98,00	F	•						
		655800	BMU		660,00 ◦	3500	16,40	140	B	766113	U	13	120,00	G	•						
										701514	4	13	195,00	G	•	•	◦	◦	C	E	
Touran (1T) (456700, incluido tapa paragolpes) (incluido BlueMotion, Cross, GLP)	02/2003 - 10/2015	356600	Cisne		173,00 •	1500	8,90	75	A	766107	U	7	98,00	F	•						
	02/2003 - 09/2006	456700	BMA		373,00 •	1800	10,00	75	B	766113	U	13	120,00	G	•						
	10/2006 - 10/2015	480600	BMA		373,00 •	1800	10,00	75	A	756744	U	13	195,00	H	•	•	◦	◦	C	N	
	10/2006 - 10/2015	622400	BMU		453,00 ◦	1800	10,00	75	A												
Touran (1T,5T) (608800: excluido R-Line) (676600: incluido R-Line, Adblue)	11/2015 -	608700	Cisne		195,00	1800	10,00	80	A	766107	U	7	98,00	F	•						
		608800	BMA		375,00	1800	10,00	80	A	766113	U	13	120,00	G	•						
		676600	BMU		415,00	1800	10,00	80	A	701504	4	13	179,00	H	•	•	◦	◦	C	N	
Transporter T4 Furgón (incluido Caravel, California, Multivan, 4Motion) (excluido V6)	01/1996 - 04/2003	266900	Cisne		242,00	2500	13,00	100	B	766007	U	7	13,50	E							
										766013	U	13	39,50	F							
Transporter T5 Furgón (incluido Caravel, California, Multivan, 4Motion) (437100 y 426900 excluido con sensor marcha atrás) (468400, incluido con sensor marcha atrás)	04/2003 - 03/2015	437100	Cisne		195,00	2800	14,00	120	B	766107	U	7	98,00	F	•						
		426900	Placa		215,00	2800	14,00	120	B	766113	U	13	120,00	G	•						
		468400	BMAh		385,00	2800	14,00	120	B	756734	2	13	10/2009-	255,00	H	•	•	◦	◦	C	E
Transporter T6 Furgón (incluido Caravel, California, Multivan, 4Motion) (incluido con sensor marcha atrás)	04/2015 -	437100	Cisne		195,00	2800	14,00	120	B	766107	U	7	98,00	F	•						
		426900	Placa		215,00	2800	14,00	120	B	766113	U	13	120,00	G	•						
		468400	BMAh		385,00	2800	14,00	120	B	756734	2	13		255,00	H	•	•	◦	◦	C	E
		606000	BMU		455,00	2800	14,00	120	B												
Transporter T5 Chasis Cabina (incluido 4Motion)	04/2003 - 04/2015	404200	Placa		349,00	2800	14,00	120	A	766107	U	7	98,00	F	•						
										766113	U	13	120,00	G	•						
Transporter T6 Chasis Cabina (incluido 4Motion)	05/2015 -	404200	Placa		349,00	2800	14,00	120	A	766107	U	7	98,00	F	•						
										766113	U	13	120,00	G	•						

Datos vehículo		Datos enganche										Datos kit eléctrico																											
VOLVO																																							
850 Break (LW)	06/1991 - 10/1997	215800	Cisne		249,00	1800	9,50	75	B	766107	U	7	98,00	F	•																								
		346000	BMC		449,00 ◦	1800	9,50	75	B	766113	U	13	120,00	G	•																								
C30 <small>(incluido Drive 2010-2012) (comprobar MMR)</small>	10/2006 - 12/2012	485300	Cisne		275,00 •	1600	8,90	75	B	766107	U	7	98,00	F	•																								
										766113	U	13	120,00	G	•																								
C70 I Cabrio	03/1998 - 10/2005	346000	BMC		449,00 ◦	1800	9,50	75	B	766107	U	7	98,00	F	•																								
										766113	U	13	120,00	G	•																								
C70 I Coupé	03/1997 - 09/2002	346000	BMC		449,00 ◦	1800	9,50	75	B	766107	U	7	98,00	F	•																								
										766113	U	13	120,00	G	•																								
S40 I (VS)	07/1995 - 03/1999	254000	Cisne		230,00 ◦	1400	7,90	75	B	766107	U	7	98,00	F	•																								
										766113	U	13	120,00	G	•																								
S40 I (VS)	04/1999 - 06/2004	360000	Cisne		230,00 ◦	1500	8,50	75	B	766107	U	7	98,00	F	•																								
										766113	U	13	120,00	G	•																								
S40 II (MS) <small>(excluido R-Design)</small>	01/2004 - 02/2012	421400	Cisne		220,00 ◦	1600	8,90	75	B	766107	U	7	98,00	F	•																								
		431400	BMA		400,00 ◦	1600	8,90	75	B	766113	U	13	120,00	G	•																								
S60 I (R) <small>(incluido 4WD, R)</small>	07/2000 - 04/2010	334100	Cisne		239,00 ◦	1600	9,10	85	B	766107	U	7	98,00	F	•																								
		334200	BMC		419,00 ◦	1600	9,10	85	B	766113	U	13	120,00	G	•																								
S60 II (F) <small>(excluido 4WD, Cross Country y R-Design)</small>	04/2010 -	604500	Cisne		239,00 •	1800	10,00	90	B	766107	U	7	98,00	F	•																								
		604600	BMAh		419,00 •	1800	10,00	90	B	766113	U	13	120,00	G	•																								
										759294		13	180,00	G	• •																								
S70 (LS) <small>(excluido 4WD)</small>	11/1996 - 11/2000	215800	Cisne		249,00	1800	9,50	75	B	766107	U	7	98,00	F	•																								
		346000	BMC		449,00 ◦	1800	9,50	75	B	766113	U	13	120,00	G	•																								
S80 II (AS) <small>(incluido 4WD)</small>	03/2006 -	485100	Cisne		265,00 ◦	2100	11,00	90	B	766107	U	7	98,00	F	•																								
		492900	BMAh		455,00 •	2100	11,00	90	B	766113	U	13	120,00	G	•																								
										759294		13	180,00	G	• •																								
S90 II	03/2016 -	622900	BMU		469,00 ◦	2200	11,30	110	B	766107	U	7	98,00	F	•																								
										766113	U	13	120,00	G	•																								
										759314		13	175,00	G	• • •																								

* Hasta finalización de stock

THULE



Thule Edge

NEW

Simplemente perfecta.

Sistema de barras de techo aerodinámico, de perfil bajo, para disfrutar de viajes extraordinariamente silenciosos, fácil instalación de los accesorios y diseño integrado.

- » Ligera. Está fabricada en aluminio ligero y puede transportar de forma segura cargas de hasta 75 kg.
- » Guía en T para un montaje rápido de accesorios Thule.
- » TrailEdge que reduce la resistencia aerodinámica.
- » WinDiffuser desvía las corrientes de aire para reducir el ruido y mejorar la economía del combustible.

Consulte los consejos generales de uso en la página 155.

CITY CRASH

Complies with ISO norm



Consulte las opciones disponibles de cada vehículo en www.thu2.es

THULE



NEW

Thule Evo

Instalación más sencilla de accesorios.

Desarrollado para simplificar tu vida activa, Thule WingBar Evo es la evolución.

Ahora cuenta con el exclusivo Quick Access que permite una instalación de accesorios más rápida. Su forma aerodinámica junto con el Trail Edge™ y WindDiffuser™, minimiza el ruido y mejora la eficiencia del consumo de combustible.

- » Aluminio ligero.
- » Guía en T que facilita el montaje rápido de los portaequipajes.
- » El WindDiffuser desvía las corrientes de aire para reducir el ruido y mejorar la economía del combustible.
- » SwingBlade que facilita el acceso a la guía en T.
- » SmartSlide, una innovadora tapa para la guía con escala de longitud.
- » Carga máxima: 100 kg.
- » Quick Access permite una suave instalación y desmontaje de accesorios.
- » Trail Edge reduce la resistencia aerodinámica.

Consulte los consejos generales de uso en la página 155.



WindDiffuser™

Desvía las corrientes de aire.



SwingBlade

Facilita el acceso a la guía en T.



Quick Access

Guía en T para un montaje rápido de accesorios.



SmartSlide

Escala de longitud y cubierta aerodinámica.

CITY CRASH

Complies with ISO norm

Thule WingBar Evo Black



Thule WingBar Evo



Consulte las opciones disponibles de cada vehículo en www.thu2.es

THULE



Thule SlideBar Evo

La exclusiva barra portaequipajes con función deslizante bidireccional para que la carga sea extremadamente fácil.

- » Deslizamiento bidireccional (60 cm en cada dirección).
- » Bloqueo rápido automático de seguridad.
- » Cierre de seguridad en ambos lados para que el usuario pueda bloquear el sistema y evitar que se utilice sin permiso.
- » Sistema de color rojo para indicar si está abierto o cerrado.
- » Paneles de agarre forrados de goma para un agarre de seguridad adicional cuando se utiliza la función deslizamiento.
- » Carga máxima: 100 kg (Según norma ISO).

Consulte los consejos generales de uso en la página 155.

CITY CRASH

Complies with ISO norm



Consulte las opciones disponibles de cada vehículo en www.thu2.es



Thule SquareBar Evo

- » Barras tradicionales fabricadas en acero con revestimiento en polímero negro.
- » Disponible en largos desde 108 a 150 cm para el ajuste al ancho del techo del vehículo.



Thule ProBar Evo

- » Diseño único de tres ranuras que permite el ajuste de múltiples accesorios.
- » En el rail superior se puede colocar el Tope Thule, el portaescaleras Thule, el soporte para escaleras Thule,... Cada accesorio se monta en apenas unos segundos.
- » En el rail lateral posterior se puede alternar entre el Rodillo Thule, el Tope plegable Thule y el Perno Thule, o los puede montar al mismo tiempo.

Consulte los consejos generales de uso en la página 155.



**Tope de carga
Thule 314/315/321**
Robustos y funcionales que mantienen la carga firmemente en su lugar e impide su deslizamiento.



Rulo Thule 334/335/340
Facilitan la carga y descarga de escaleras, tabloneros y objetos largos.



**Portaescaleras extensible
Thule 311**
Portaescaleras que protege tu espalda y te hace ganar tiempo.



**Cofre portatubos
Thule 317**
Mantiene y protege los tubos de la forma más segura posible.



Thule Eye Bolt 320
Si vas a instalar el portaequipajes en una THULE Slide Bar quizás necesites un cárcamo Thule Eye Bolt para usar la función deslizante.
Ref. 320000 · PVR: 18,93 €

* Más accesorios línea profesional Thule en la página 218



Consulte las opciones disponibles de cada vehículo en www.thu2.es



Cruz Airo Fuse / Airo Fuse Dark

Barras aerodinámicas de aluminio integradas

Barras aerodinámicas integradas de aluminio en acabado plata o negro texturizado. Las barras de techo Cruz Airo Fuse cuentan con perfiles aerodinámicos de aluminio que se integran y fusionan con los cierres de las barras, lo que se adapta a la perfección con los diseños de vehículos actuales.

- » Capacidad de carga hasta 75 kg.
- » Guía en T para un montaje rápido de accesorios.
- » Montaje en combinación con los kits Optiplus Fix.
- » Atenuación de ruido mejorada, mejora del coeficiente aerodinámico.
- » Fácil montaje sobre el techo.

Consulte los consejos generales de uso en la página 155.



Cruz Airo Fuse



Cruz Airo Fuse



Cruz Airo Fuse Dark

Cruz Airo	mm	i	Max. Kg		TUV-GS	City-Crash	CEPE/ONU
Cruz Airo Fuse	820-1140	F-I-C	75	<input type="checkbox"/>	✓	✓	✓
Cruz Airo Fuse Dark	820-1140	F-I-C	75	<input type="checkbox"/>	✓	✓	✓

PLATA ALUMINIO

NEGRO ALUMINIO

Consulte las opciones disponibles de cada vehículo en www.thu2.es



Cruz Airo / Airo Dark

Barras aerodinámicas de aluminio

- » Diseño atractivo y eficiente.
- » Fácil montaje.
- » Mejor coeficiente aerodinámico.
- » Atenuación de ruido mejorada.
- » Fácil montaje de accesorios en la ranura superior.
- » Opcional: juego de cerraduras antirrobo.
- » Airo T: fijación al borde del techo.
- » Airo X: fijación con puntos de anclaje, Railing integrado o Carril.
- » Airo R: fijación a Railing elevado.
- » Airo FIX: menor altura del pie (1).

Consulte los consejos generales de uso en la página 155.



Cruz Airo FIX / Airo Dark FIX



(1)
Cruz Airo Fix

Cruz Airo X/T

Cruz Airo R

(1)
Cruz Airo Fix Dark

Cruz Airo Dark X/T

Cruz Airo Dark R

Cruz Airo	mm	i	Max. Kg		TÜV-GS	City-Crash	CEPE/ONU
Airo FIX / Airo FIX Dark	1080-1330	F-I	75	932-0xx	✓	✓	✓
Airo X / Airo X Dark	1080-1330	F-I-C	75	932-0xx	✓	—	✓
Airo T / Airo T Dark	1080-1330	B	60-75	932-0xx	✓	✓	✓
Airo R / Airo R Dark	1080-1330	R	75	✓	✓	✓	✓



Consulte las opciones disponibles de cada vehículo en www.thu2.es



Cruz Aluminio

Barras de Aluminio

- » Mayor seguridad y aerodinámica.
- » Fácil montaje de accesorios en la ranura superior.
- » Tensor integrado.
- » Opcional cerraduras antirrobo.

Consulte los consejos generales de uso en la página 155.



- **Oplus AT:** al borde del techo.
- **Oplus AX:** con puntos de anclaje, railing integrado o carril.



- **Alu T:** al borde del techo (tensor por fuera).
- **Alu S:** con puntos de anclaje o carril.



- **Alu R:** railing alto.

Cruz Aluminio	mm		Max. Kg		TÜV-GS	City-Crash	CEPE/ONU
Oplus AX	1080-1280	F-I-C	75	932-014	✓	✓	✓
Oplus AT	1080-1330	B	75	932-01xx	✓	✓	✓
Oplus Alu R	1080-1330	R	75	✓	✓	✓	✓
Optima Alu S	1080-1280	F-C	50-60	932-014	✓	✓	✓
Optima Alu T	1080-1180	B	50-75	932-014	✓	✓	✓

Consulte las opciones disponibles de cada vehículo en www.thu2.es



Cruz Acero

Barras de acero galvanizado

- » Cruz Oplus S-Fix con pies de altura reducida.
- » Cruz Oplus SX/ST con soportes de doble cierre en ABS.
- » Cruz Oplus SR+ para vehículos equipados con railing de techo.
- » Cruz Optima OS/OT la gama económica y versátil.

Consulte los consejos generales de uso en la página 155.



Cruz FIX



- **Oplus ST:** al borde del techo.
- **Oplus SX:** con puntos de anclaje, railing integrado o carril.



- **OT:** al borde del techo (tensor por fuera).
- **OS:** con puntos de anclaje o carril.



- **SR+:** railing alto.

Cruz Acero	mm	F-I-C	Max. Kg	932-014	TÜV-GS	City-Crash	CEPE/ONU
Oplus SX	1100-1300	F-I-C	75	932-014	✓	✓	✓
Oplus ST	1100-1330	B	60-75	932-0xx	✓	✓	✓
Oplus SR+	1100-1330	R	75	✓	✓	✓	✓
Optima OS	1080-1280	F-C	50-60	932-014	✓	✓	✓
Optima OT	1080-1180	B	50-75	932-014	✓	✓	✓

Consulte las opciones disponibles de cada vehículo en www.thu2.es



* Más accesorios línea profesional Cruz en la página 219

Cruz Profesional

Acero galvanizado reforzado

- » Diseño funcional.
- » Máxima robustez para soportar los trabajos más duros.
- » Fácil montaje de accesorios.
- » Mayor resistencia y protección anticorrosiva.
- » Opcional: cerraduras antirrobo.

Consulte los consejos generales de uso en la página 155.



Cruz Cargo Spro

- » Dimensiones 30 x 20
- » Kit de montaje específico según modelo de vehículo.



Cruz Cargo Xpro

- » Dimensiones 35 x 35
- » Perfil cuadrado.
- » Kit de montaje específico según modelo de vehículo.



Cruz Xpro SF

- » Dimensiones 35 x 35
- » Perfil cuadrado.
- » Kit de montaje específico según modelo de vehículo.

Cruz Profesional	mm	Max. Kg		TÜV-GS	City-Crash	CEPE/ONU
Cargo Spro	1050-1200 B-F-C	150	932-0xx	✓	✓	✓
Cargo Xpro	1250-1750 B-F-C	150	932-0xx	✓	✓	✓
Cargo Xpro SF	1080-1330 R	75	932-0xx	✓	✓	✓

Consulte las opciones disponibles de cada vehículo en www.thu2.es



* Más accesorios línea profesional Cruz en la página 219

Cruz Alu Cargo / Alu Cargo Dark

Barras de aluminio para profesionales

- » Perfil de 3 ranuras para fácil acoplamiento de accesorios.
- » Mayor resistencia y protección anticorrosiva.
- » Kit de fijación específico según modelo de vehículo.
- » Opcional cerraduras antirrobo.

Consulte los consejos generales de uso en la página 155.



Cruz Safari

- » Robusto, duradero y con gran capacidad de carga.
- » Deflector incluido para mejorar la aerodinámica y seguridad.
- » Barandillas de seguridad en todo el perímetro.
- » Accesorios opcionales: Consulte la página 215.

Consulte los consejos generales de uso en la página 155.



Cruz Safari

Safari



1325-2625 1100-1400



180



Consulte las opciones disponibles de cada vehículo en www.thu2.es



* Más accesorios línea profesional Cruz en la página 219

Cruz Evo Rack Pro

Portaequipajes robusto y ergonómico, reduce el tiempo de montaje

- » Fabricado en acero galvanizado.
- » Robusto y ergonómico.
- » Perfiles de mayor sección
- » Nuevo deflector de aluminio, barandillas laterales de mayor altura.
- » Incluye rulo de carga.
- » Rápido montaje.
- » Accesorios opcionales: escalera, topes de retención, portaescaleras,...

Consulte los consejos generales de uso en la página 155.



☰	913-xxx
	Cruz Evo Rack Pro
↔ L ↔	180-440 cm
↔ W ↔	110-170 cm
⬇ Max	180 kg
	■
	■
	■
	□ 93201X
	B-F-C
	✓
	-(*)

(*) Rulo no compatible con vehículos con portón trasero

Consulte las opciones disponibles de cada vehículo en www.thu2.es



* Más accesorios línea profesional Cruz en la página 219

Cruz Evo Rack

Portaequipajes de acero reforzado con diseño compacto y ergonómico

- » Fabricado en acero galvanizado con acabado texturado.
- » Nuevo diseño que confiere mayor rigidez al conjunto.
- » Carril interior continuo que mejora el tiempo de montaje.
- » Nuevo deflector en aluminio.
- » Rediseño de medidas para una mejor adaptación a cada modelo de vehículo.
- » Accesorios opcionales: Rulo de carga con ajuste longitudinal, pasarela, topes de retención de carga, escalera...

Consulte los consejos generales de uso en la página 155.

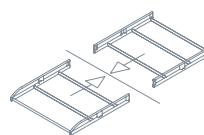

≡	909-xxx
	Cruz Evo Rack
← L →	130-480 cm
← W →	110-170 cm
Max	180 kg
	■
	■
	□
	□ 93201X
	B-F-C
	✓
	✓ (*)

(*) Rulo no compatible con vehículos con portón trasero

Consulte las opciones disponibles de cada vehículo en www.thu2.es



* Más accesorios línea profesional Cruz en la página 219

Cruz Evo Rack Alu

Portaequipajes ergonómico fabricado en aluminio anodizado mate

- » Fabricado en aluminio en su totalidad.
- » Sistema de fijación rápida con diseño aerodinámico.
- » Carril posterior para acoplamiento de accesorios.
- » Nuevas barandillas laterales de mayor altura para una mayor seguridad.
- » Incluye rulo de carga.
- » Opcional: pasarela, topes de retención de carga.

Consulte los consejos generales de uso en la página 155.



☰	911-xxx
	Cruz Evo Rack Alu
← L →	130-480 cm
← w →	110-170 cm
📦 ↓ Max	180 kg
	■
	■
	■
🔑	□ 93201X
	B-F-C
	✓
	✓

Consulte las opciones disponibles de cada vehículo en www.thu2.es

Utiliza nuestro buscador de barras en la web thu2.es

ENGANCHES

BARRAS DE TECHO

PORTABICICLETAS

COFRES

PORTAEQUIPAJES

ACCESORIOS

> Buscador de barras

BUSCADOR DE BARRAS

CATEGORÍAS

ENGANCHES

BARRAS DE TECHO

> Barras de techo Thule

> Barras de techo Cruz

> Bacas

PORTABICICLETAS

COFRES

PORTAEQUIPAJES

ACCESORIOS



BARRAS DE TECHO
THULE



BARRAS DE TECHO
CRUZ



BACAS

Barras de techo

Tenemos las barras de techo perfectas para tu vehículo. Tú eliges, para ocio o para el trabajo de cada día. Máxima calidad, máxima seguridad. Después sólo necesitas el accesorio de transporte.



Consejos generales de uso para barras y portaequipajes de techo

- Lea y siga las instrucciones de montaje y las recomendaciones si las hubiera.
- Limpie el techo del automóvil y las piezas del producto que estén en contacto con el techo.
- Si en las instrucciones del sistema portacargas o de su vehículo no se indican posiciones fijas de montaje especiales, se mantendrá una distancia mínima de 700 mm entre las barras/fijaciones del sistema portacargas. Al transportar cargas largas, la distancia entre las secciones del sistema portacargas no deberá ser inferior a 600 mm.
- consulte la compatibilidad de las barras o del sistema portaequipajes si su vehículo está provisto de techo solar, techo panorámico o techo panorámico practicable. En ningún caso se podrá abrir/ practicar el techo con las barras de techo o el sistema portaequipajes instalado. En algunos vehículos es posible que se deba desmontar la antena de techo para utilizar el sistema portacargas.
- No transporte objetos que por su forma, contenido o naturaleza puedan suponer un peligro en carretera.
- No deberá sobrepasar la carga máxima indicada en las instrucciones de montaje o la indicada por el fabricante del vehículo acerca de la carga máxima permisible sobre el techo, siendo la menor de ellas la que prevalecerá en todo momento.
- carga máxima sobre el techo = peso del sistema portacargas + peso de la carga
- La carga debe repartirse uniformemente sobre toda la superficie del sistema portacargas, manteniendo el centro de gravedad lo más bajo posible. Es conveniente que la carga no sobresalga del sistema portacargas, y si lo hiciera deberá siempre cumplir con la reglamentación vigente en cuanto a distancias y señalización.
- Utilice accesorios específicos para el transporte de bicicletas, esquís, canoas, tablas de surf, ..., y asegúrese de que no haya piezas sueltas que puedan desprenderse durante el transporte.
- Será el usuario el único responsable de seguir las instrucciones y recomendaciones de uso.
- Extreme las precauciones durante la conducción con carga sobre el techo del vehículo y haga caso de las recomendaciones indicadas en los manuales de instrucciones de cada sistema portacargas.

Consulte las opciones disponibles de cada vehículo en www.thu2.es



Escalera Fija Trasera



Escalera Fija sobre la puerta trasera.
Incluidas puertas acristaladas.



Rulo Extensible



Pasarela





Topes Laterales



Correa con trinquete



Tapa con llave



Anilla



Transporte de tubos







Thule EasyFold XT 933/934/ 933 B/934 B

El portabicicletas plegable y fácil de usar.

- » Brazos desmontables con pomos limitadores de apriete Thule AcuTight (para cuadros redondos y ovalados de 22-80 mm).
- » Plegable para un fácil montaje y guardado.
- » Permite el transporte de bicicletas eléctricas.
- » Más espacio entre las bicicletas.
- » Abatible con pedal de pie para acceso al maletero.
- » Acoplamiento con una mano con baja fuerza de cierre para facilitar el montaje del portabicicletas.
- » Asas integradas.
- » Correas compatibles con ruedas hasta 4,7" (Fatbikes).
- » Conector de 13 polos.
- » Sistema antirrobo en bicicletas y cabezal.

2 bicis Ref.: **933100** · PVR: **653,68 €**

2 bicis Ref.: **933101** · PVR: **731,36 €** (Black)

3 bicis Ref.: **934100** · PVR: **742,11 €**

3 bicis Ref.: **934101** · PVR: **818,97 €** (Black)



Bolsa de transporte

Thule EasyFold XT Carrying Bag

931 2 bicis Ref. **931100** · PVR: **31,32 €**

934 3 bicis Ref. **934400** · PVR: **37,11 €**



Correas de ajuste rápido
Juego de correas XXL
Ref. **985000** · PVR: **11,53€**



Acoplamiento con una mano



Abatible



Ruedas para transporte sólo
934100 y 934101
Ref. **917300** PVR: **34,63 €**



Rampa plegable
Ref. **933400** PVR: **48,68 €**

THULE



2-4



Thule VeloCompact 924/926

Completo, versátil e innovador.

- » Nuevo cabezal que ofrece más seguridad y estabilidad.
- » Capacidad de 2 hasta 4 bicicletas (adaptador opcional).
- » Brazos desmontables.
- » Abatible con pedal de pie para acceso al maletero.
- » Patines de apoyo de ruedas extensibles para bicicletas de hasta 29".
- » Sistema antirrobo en bicicletas y cabezal.
- » Premontado, no requiere herramientas.
- » Conector de 13 polos.
- » Disponible en dos tamaños:
 - 2 bicis Ref.: **924001** · PVR: **461,07 €**
 - 3 bicis Ref.: **926001** · PVR: **562,73 €**
- » Accesorios opcionales:
 - Extensión para bicicleta adicional (solo 926)
Ref.: **926101** · PVR: **143,76 €**



Sistema de Cabezal
Thule VeloCompact
926-927



Abatible



Correas de ajuste rápido



Adaptador salvarueda
Ref. 924100 · PVR: 73,47 €



Rampa de carga Thule VeloCompact
Ref. 915200 · PVR: 40,41 €



THULE



2-4



Thule VeloCompact 925/927

Completo, versátil e innovador.

- » Nuevo cabezal que ofrece más seguridad y estabilidad.
- » Capacidad de 2 hasta 4 bicicletas (adaptador opcional).
- » Brazos desmontables.
- » Abatible con pedal de pie para acceso al maletero.
- » Patines de apoyo de ruedas extensibles para bicicletas de hasta 29".
- » Sistema antirrobo en bicicletas y cabezal.
- » Premontado, no requiere herramientas.
- » Conector de 7 polos.
- » Disponible en dos tamaños:
 - 2 bicis Ref.: **925001** · PVR: **367,69 €**
 - 3 bicis Ref.: **927001** · PVR: **470,99 €**



- » Accesorios opcionales:
 - Extensión para bicicleta adicional (solo 927)
Ref.: **926101** · PVR: **143,76 €**



Abatible con el pie



Abatible



Correas de ajuste rápido

Adaptador salvavueda
Ref. **924100** · PVR: **73,47 €**Sistema de Cabezal
Thule VeloCompact
924-925

THULE

**Composición foto:**

- » Thule VeloSpace XT 938
- » Thule BackSpace XT 9383
- » Extensión 1 bici 938100
- » Brazo 938200

Thule BackSpace XT 9383

Cofre de carga ligero y duradero. El complemento perfecto para el porta bicicletas Thule VeloSpace XT 938 Y 939.

- » Se integra sobre los portabicicletas Thule VeloSpace 938 y 939.
- » Fácil de guardar cuando no se utiliza gracias a su estructura ligera y plegable.
- » Asas de transporte integradas para un sencillo transporte del cofre.
- » Su baja altura facilita la carga y descarga.
- » Volumen de carga 300 l.
- » Dimensiones: 137 x 46,5 x 68 cm.
- » Capacidad de carga: 50 kg
- » Peso neto: 8,6 kg

Ref.: **938300** · PVR: **509,01 €**



Cofre Thule BackSpace XT plegado



Cierre de seguridad



Fijación rápida al portabicicletas



Abatible

**Brazo fijación para cuadro**

Brazo de fijación para cuadro necesario si se utiliza el cofre Thule BackSpace XT + 1 bici. Necesaria Extensión 938100.

Para XT2 bici Ref. **938200** · PVR: **33,80 €**

Para XT3 bici Ref. **939200** · PVR: **33,80 €**

THULE®



Thule VeloSpace XT 938/939/938 B/939 B

Versátil. Para todo tipo de bicicletas

- » Alta capacidad de carga 2, 3 o 4 bicicletas (adaptador opcional)*.
- » Apto para FatBike, bicicletas eléctricas y Pedelects**. (Necesita correas XXL).
- » Anchura entre carriles 25 cm.
- » Carriles extralargos. Permite bicicletas de hasta 1300 mm entre ejes.
- » Hebillas de apertura rápida.
- » Conector de 13 polos
- » Combínalo con el Thule BackSpace 9383 para tener un completo portaequipajes.

2 bicis Ref.: **938000** · PVR: **570,21 €**

2 bicis Ref.: **938001** · PVR: **607,40 €** (Black)

3 bicis Ref.: **939000** · PVR: **661,12 €**

3 bicis Ref.: **939001** · PVR: **696,65 €** (Black)

Accesorios opcionales:

*Extensión para bicicleta adicional (938 y 939) Ref.: **938100** · PVR: **151,98 €**

**Correas XXL

Ref.: **985000** · PVR: **11,53 € / bici**



Abatible con el pie



Abatible



Rampa de carga

Ref. **917200** · PVR: **47,85 €**



Separador rueda recambio

Ref. **939400** · PVR: **77,60 €**



Rueda de transporte

Ref. **917300** · PVR: **34,63 €**

THULE



2-3



Thule EuroRide 941/943

Estable, compacto y basculante

- » Sistema de bloqueo sobre bola manual.
- » Abatible manual para acceso al maletero.
- » Bloqueo de portabicicletas y de las bicicletas.
- » Abrazaderas de rueda movibles con correas suaves.
- » Para cuadros hasta 70 mm.
- » Conector de 7 polos.
- » Disponible en dos tamaños:

Thule EuroRide 2 bicicletas · 941005 · PVR: 310,66 €

Thule EuroRide 3 bicicletas · 943005 · PVR: 380,91 €



Basculante



Correas



Cabezal Manual

THULE

Thule RideOn 9502/9503

Estable, basculante y buena relación calidad-precio.

- » Sistema de bloqueo de bola manual.
- » Función abatible para acceso al maletero.
- » Las bicicletas se sujetan mediante resistentes correas.
- » Disponible en dos tamaños:

Thule RideOn 2 bicicletas · **950200** · PVR: **238,76 €**

Thule RideOn 3 bicicletas · **950300** · PVR: **269,34 €**



Thule HangOn 972/974/9708

- » Sin ajustes previos.
- » Se pliega para un fácil almacenamiento.
- » Abrazaderas del cuadro suaves y protectoras.
- » Preparado para acoplar el accesorio Thule Lightboard 976 con el adaptador Ref.: 9761 (PVR 16,49€).
- » El 972 y el 9708 son abatibles con las bicicletas cargadas.
- » Disponible en tres tamaños:

Thule HangOn para 3 bicicletas · Ref.: **974000** · PVR: **104,05 €**

Thule HangOn para 3 bicicletas · Ref.: **972000** · PVR: **119,75 €**

Thule HangOn para 4 bicicletas · Ref.: **970805** · PVR: **150,33 €**



Thule Express 970

- » Para dos bicicletas. Rápido, ligero y sencillo.
- » Se adapta a la mayoría de los tamaños de cuadro.
- » Abrazaderas del cuadro suaves y protectoras.
- » Preparado para acoplar el accesorio Thule Lightboard 976 con el adaptador Ref.: 9761 (PVR 16,49€).
- » Se pliega para un fácil almacenamiento.

Ref.: **970003** · PVR: **66,86 €**





Spinder Xplorer+

Plegable para 2 o 3 bicicletas

- » Brazos extensibles con 360° de giro. Agarre a la tija del sillín. Compatible con todo tipo de cuadros.
- » Plegable para un fácil montaje y guardado.
- » Permite el transporte de bicicletas eléctricas.
- » Más espacio entre las bicicletas.
- » Abatible con pedal de pie para acceso al maletero.
- » Ruedas hasta 2,8" (sin protector de llanta).
- » Cabezal automático con cierre de seguridad.
- » Asas integradas.
- » Conector de 7 y 13 polos.
- » Sistema antirrobo en bicicletas y cabezal.
- » Peso: 17 kg.
- » Carga Máxima: 60 kg.
- » Dimensiones plegado: 64 x 25 x 72 cm



2 bicis Ref: **405085** · PVR: **445,00 €**



Adaptador 3ª bici

Ref. **405084** · PVR: **95,00 €**



Plegable



Bolsa de transporte

Ref. **405083** · PVR: **33,00 €**



Correas de ajuste rápido



Asa para transporte



Abatible



Rampa plegable

Ref. **405082** · PVR: **33,00 €**

PROUSER BIKE CARRIERS

Diamant TG

Plegable para 2 o 3 bicicletas

- » Cabezal automático con seguridad.
- » Plegable para facilitar su transporte y almacenaje.
- » Abatible con pedal.
- » Brazos desmontables con correas de ajuste laminadas en acero, que se pueden girar y orientar en cualquier dirección.
- » Compatible con bicicletas eléctricas.
- » 3ª bicicleta con adaptador opcional.
- » Ruedas hasta 2,8" (sin protector de llanta).
- » Incluye protector de llanta.
- » Peso: 17 kg.
- » Carga Máxima: 60 kg.
- » Dimensiones plegado: 58 x 30 x 72 cm



Ref.: **405092** · PVR: **430,00 €**



Adaptador 3ª bici

Ref. **405093** · PVR: **95,00 €**



Plegable



Bolsa de transporte

Ref. **405095** · PVR: **33,00 €**



Correas de ajuste rápido



Asa para transporte



Abatible



Rampa plegable

Ref. **405094** · PVR: **33,00 €**

PROUSER
BIKE CARRIERS

Diamant

Plegable para 2 bicicletas

- » Cabezal automático con cierre de seguridad.
- » Plegable para un fácil montaje y guardado.
- » Brazos desmontables con pomo antirrobo.
- » Permite el transporte de bicicletas eléctricas.
- » Dimensiones de cuadro de 22 a 75 mm Ø
- » Ruedas hasta 2"
- » Abatible con pedal de pie para acceso al maletero.
- » Asas integradas.
- » Conector de 7 y 13 polos.
- » Bolsa de transporte incluida
- » Peso: 18 kg.
- » Carga Máxima: 60 kg.
- » Dimensiones plegado: 55 x 25 x 68 cm



2 bicis Ref.: [405072](#) · PVR: **365,00 €**



Bolsa de transporte incluida



Plegable



Abatible



Correas de ajuste rápido

PROUSER BIKE CARRIERS

Diamant SG2 PLUS

Para vehículos con puerta de maletero grande.

- » Plegable para un fácil montaje y guardado.
- » Válido para FatBike (adaptador Ref.: 405076)
- » Brazos desmontables de fijación al cuadro hasta $\varnothing 75$ mm.
- » Permite el transporte de bicicletas eléctricas.
- » Más espacio entre las bicicletas.
- » Abatible con pedal de pie para acceso al maletero.
- » Cabezal automático con cierre de seguridad.
- » Asas integradas.
- » Sistema antirrobo en bicicletas y cabezal.
- » Conector de 7 y 13 polos.
- » Bolsa de transporte incluida.
- » Peso: 17 Kg
- » Carga máxima: 60 Kg
- » Dimensiones de plegado: 65 x 30 x 70 cm



2 bicis Ref. · 405070 · PVR: 445,00 €



Bolsa de transporte incluida



Compatible con vehículos con portón de maletero grande.
VW Transporter, MB Viano/Vito, Renault Trafic, Citroën Space Tourer, Peugeot Traveller...



Correas de ajuste rápido con protector de llanta

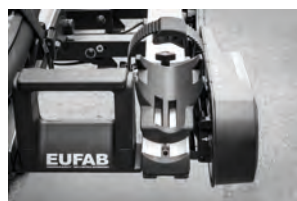

Asa para transporte



Rampa plegable

Ref. 405077 · PVR: 33,00 €



Adaptador Fat bike

Ref. 405076 · PVR: 29,00 €

PROUSER
BIKE CARRIERS

1



AMBER I

Fácil de colocar para llevar 1 bicicleta

- » Para instalar sobre la bola de remolque.
- » Cabezal de acople con palanca.
- » Seguridad con candado.
- » Fijación de la bicicleta mediante correas.
- » Patines de apoyo de plástico.
- » Enchufe combinado de 7 y 13 polos.
- » Incluye luz antiniebla y luz de marcha atrás (sólo en 13 polos).
- » Abatible: No
- » Peso: 9,5 kg.
- » Carga Máxima: 30 kg.

Ref.: 405061 · PVR: 175,00 €



Cabezal con palanca



Abatible

2



AMBER II

Fácil de colocar para llevar 2 bicicletas

- » Para instalar sobre la bola de remolque.
- » Cabezal de acople con palanca.
- » Seguridad con candado.
- » Fijación de la bicicleta mediante correas.
- » Patines de apoyo de plástico.
- » Enchufe combinado de 7 y 13 polos.
- » Incluye luz antiniebla y luz de marcha atrás (sólo en 13 polos).
- » Abatible: Si
- » Peso: 15 kg.
- » Carga Máxima: 50 kg.

Ref.: 405062 · PVR: 210,00 €



Cabezal con palanca

AMBER III

3



Fácil de colocar, para llevar 3 bicicletas

- » Para instalar sobre la bola de remolque.
- » Cabezal de acople con palanca.
- » Seguridad con candado.
- » Fijación de la bicicleta mediante correas.
- » Patines de apoyo de plástico.
- » Enchufe combinado de 7 y 13 polos.
- » Incluye luz antiniebla y luz de marcha atrás (sólo en 13 polos).
- » Abatible: Si
- » Peso: 16 kg.
- » Carga Máxima: 60 kg.

Ref.: 405063 · PVR: 260,00 €



Cabezal con palanca



Abatible

AMBER IV

4



Fácil de colocar, para llevar 4 bicicletas

- » Para instalar sobre la bola de remolque.
- » Cabezal de acople con palanca.
- » Seguridad con candado.
- » Fijación de la bicicleta mediante correas.
- » Patines de apoyo de plástico.
- » Enchufe combinado de 7 y 13 polos.
- » Incluye luz antiniebla y luz de marcha atrás (sólo en 13 polos).
- » Abatible: Si
- » Peso: 19,5 kg.
- » Carga Máxima: 60 kg.

Ref.: 405064 · PVR: 310,00 €



Cabezal con palanca



Abatible



PROUSER
BIKE CARRIERS

Diamant Bike Lift

El más práctico para bicicletas eléctricas.

- » Plataforma con elevación eléctrica.
- » Plegable para un fácil montaje y guardado.
- » Diseñado para el transporte de bicicletas eléctricas.
- » Incorpora ruedas para su transporte.
- » Brazos desmontables de fijación al cuadro hasta $\varnothing 75$ mm.
- » Más espacio entre las bicicletas.
- » Abatible con pedal de pie para acceso al maletero.
- » Cabezal automático con cierre de seguridad.
- » Asas integradas.
- » Sistema antirrobo en bicicletas y cabezal.
- » Conector de 13 polos.
- » Bolsa de transporte incluida.
- » Peso: 25 Kg
- » Carga máxima: 60 Kg
- » Dimensiones plegado: 74 x 32 x 80 cm



2 bicis Ref. · 405071 · PVR: 710,00 €



Bolsa de transporte incluida

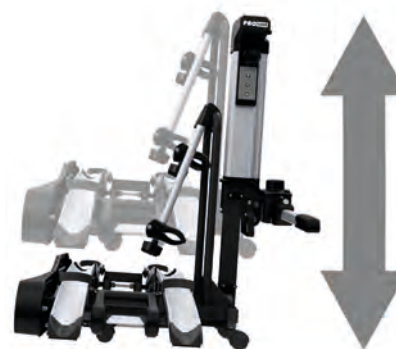

La plataforma sube y baja mediante un motor eléctrico, para cargar las bicicletas con total comodidad.



Correas de ajuste rápido con protector de llanta



Asa para transporte



Abatible con pedal



Cruz Frame

Plegable y abatible

- » Montaje sobre bola de remolque.
- » Abatible con pedal.
- » Correas de goma.
- » Sistema antirrobo en portabicicletas.
- » Plegable para facilitar el transporte y el almacenamiento.

Frame 2 Ref.: **940518** · PVR **107,40 €**

Frame 3 Ref.: **940520** · PVR: **111,53 €**

Frame 4 Ref.: **940525** · PVR: **115,66 €**



Frame 2



Frame 3



Frame 4

Modelo	Frame 2	Frame 3	Frame 4
Referencia	940518	940520	940525
Precio €	90,87	99,13	115,66
Bicicletas	2	3	4
Medidas cm	57x75x70	57x75x70	78x65x90
Peso Kg	9,5	10	13
Cuadros mm	25-70	25-70	25-70



Cabezal antirrobo



Abatible con pedal



Correas de goma

THULE



Thule UpRide 599

Máxima seguridad

- » Colocación automática de la bicicleta al ajustar las fijaciones.
- » Fijación por bloqueo a la rueda delantera.
- » Correas de ajuste rápido y seguro.
- » Diseño en aluminio ligero y elegante.
- » Admite todo tipo de cuadros.
- » Transporta bicicletas de hasta 20 kg.
- » Disponible adaptador opcional para ruedas de hasta 5".

Ref.: 599001 · PVR: 181,74 €



Thule FreeRide 532

Moderno, dinámico y funcional

- » Abrazadera del cuadro con bloqueo rápido.
- » Para cuadros redondos de 22 a 70 mm.
- » Correas de apertura rápida, ajustables a diferentes tamaños de rueda.
- » Protección antirrobo.
- » Adaptadores para guías en T de 20 mm.

Ref.: 532002 · PVR: 64,42 €



Sistema de bloqueo de rueda delantera



Correas de fijación rápida



Adaptador para Fatbikes
Ref.: 599100 PVR: 19,75 €



Abrazadera del cuadro



Bloqueo del portabicicletas sobre la barra fácil y rápido.

THULE



Thule ProRide 598

Montaje más rápido y cómodo

- » Colocación automática de la bicicleta al ajustar las fijaciones.
- » Pomo con limitador de apriete.
- » Distribución de la presión sobre el cuadro.
- » Correas de ajuste rápido y seguro.
- » Con adaptadores para guías en T de 20 mm.
- » Diseño en aluminio ligero y elegante.
- » Admite cuadros redondos de 22-80 mm.
- » Tamaño máximo cuadros ovalados 80x100 mm.
- » Transporta bicicletas de hasta 20 kg.
- » Disponible adaptador opcional (ruedas de 5").

■ Ref.: **598001** · PVR: **115,62 €**

■ Ref.: **598002** · PVR: **130,50 €**



Thule ProRide **598001**



Thule ProRide Black **598002**



Pomo con par de apriete



Correa de fijación de rueda



Pinza de bloqueo al cuadro



Adaptador para Fatbikes
Ref. **598101** · PVR: **31,32 €**



Adaptador barras cuadradas
Ref.: **889500** · PVR: **6,53 €**

THULE



Thule ThruRide 565

Avanzado..

- » Para bicicletas con ejes pasantes de 12-20 mm sin adaptadores extra. Horquilla cerrada.
- » Se ajusta a los bujes de apertura rápida de 9 mm con adaptador 565100 (PVR.: 39,59 €) sin cerradura.
- » Pomo ergonómico que optimiza la presión de sujeción.
- » Válido para bicicletas con freno de disco.
- » Protección antirrobo.
- » Sólo válido para barras con ranura en T, adaptadores de 20x20 mm incluidos.
- » Tamaño máximo de rueda 3".

Ref.: 565001 · PVR: 180,08 €



Thule OutRide 561

Sencillo, profesional y con estilo

- » Retén Snap-on ajustable a horquillas abiertas.
- » Válido para bicicletas con frenos de disco.
- » Correas con trinquete que no dañan la llanta.
- » Protección antirrobo.
- » Tamaño máximo de rueda 3".
- » Adaptadores para guías en T de 20 mm.
- » Adaptador integrado para ejes de 20 mm.

Ref.: 561000 · PVR: 130,50 €



Fijación con correa



Cabezal de fijación de horquilla



Correas de fijación rápida



Adaptador integrado



Adaptador eje 15 mm Thru Axle

Ref.: 561102 PVR: 31,32 € 15 x 100

Ref.: 561200 PVR: 31,32 € 15 x 110

Ref.: 561300 PVR: 31,32 € 12 x 100



Cruz Race/Race Dark

- » Aluminio.
- » Fácil montaje sobre todo tipo de barras.
- » Compatible con cuadros 25-80 mm.
- » Antirrobo en portabicis y bicicleta.
- » Correas de cierre rápido para las ruedas.
- » Compatible con ruedas hasta 3".

Ref.: 940011 · PVR: 51,20 €

Ref.: 940015 · PVR: 53,68 € (Dark)

Cruz Bike-Rack N

- » Acero (acabado en negro).
- » Fácil montaje sobre todo tipo de barras.
- » Compatible con cuadros: 70 x 30 mm (mín.) 90 x 65 mm (máx.)
- » Correas de fijación para las ruedas.
- » Doble pomo.

Accesorio para barras Airo (Tornillo T)

Ref.: 940424 · PVR: 6,57 €

Ref.: 940001 · PVR: 26,41 €

Cruz Bike-Rack G

- » Acero.
- » Fácil montaje sobre todo tipo de barras.
- » Compatible con cuadros: 70 x 30 mm (mín.) 90 x 80 mm (máx.)
- » Doble pomo con antirrobo.
- » Correas de fijación para las ruedas.

Accesorio para barras Airo (tornillo T)

Ref.: 940424 · PVR: 6,57 €

Ref.: 940005 · PVR: 30,54 €

Portabicicletas techo

							TUV-GS
Cruz Race Ref. 940-011	•	•	•	•	3,00 kg	max. 18 kg	•/•
Cruz Race Dark Ref. 940-015	•	•	•	•	3,00 kg	max. 18 kg	•/•
Cruz Bike-Rack N Ref. 940-001	940-424	•	•	940-400	2,80 kg	max. 15 kg	•/•
Cruz Bike-Rack G Ref. 940-005	940-424	•	•	•	3,00 kg	max. 15 kg	•/•



THULE



2



Thule ClipOn High 9105/9106

Montaje rápido y plegable.

- » Sencillo montaje con el sistema "Snap-On" exclusivo.
- » La posición elevada mantiene visibles las luces y la placa de matrícula del vehículo.
- » Transporta dos bicicletas.
- » Compatible con cuadros de 22-80 mm.
- » Se pliega rápidamente para un cómodo almacenamiento.
- » Soportes de ruedas extensibles.
- » Todas las partes en contacto con el vehículo y las bicicletas están revestidas de goma.
- » Bloquea la bici al portabicicletas con el accesorio Ref.: 538 · PVR 37,93 €
- » Consulte cuál es el kit de adaptación adecuado para su vehículo (precio desde 26,36 €).

Ref.: 910501 · PVR 278,43 €

Ref.: 910601 · PVR 278,43 €



3



Thule ClipOn

Montaje a presión, perfecto para vehículos de cinco puertas o familiares.

- » Sencillo montaje con el sistema "Snap-On" exclusivo.
- » Se le puede acoplar el panel de luces Thule Lightboard 976.
- » Transporta tres bicicletas.
- » Se pliega rápidamente para un cómodo almacenamiento.
- » Soportes de ruedas extensibles.
- » Todas las partes en contacto con el vehículo y las bicicletas están revestidas de goma.
- » Bloquea la bici al portabicicletas con el accesorio Ref.: 538 · PVR 37,93 €
- » Consulte cuál es el kit de adaptación adecuado para su vehículo (precio desde 26,36 €).

Ref.: 910301 · PVR: 148,68 €

Ref.: 910401 · PVR: 148,68 €



3



Thule FreeWay

Para transportar hasta tres bicicletas.

- » Sencillo montaje con correas ajustables.
- » Se le puede acoplar el panel de luces Thule Lightboard 976.
- » Transporta tres bicicletas.
- » Se pliega rápidamente para un cómodo almacenamiento.
- » Soportes de ruedas extensibles.
- » Todas las partes en contacto con el vehículo y las bicicletas están revestidas de goma.
- » Bloquea la bici al portabicicletas con el accesorio Ref.: 538 · PVR 37,93 €

Ref.: 968001 · PVR: 105,70 €

THULE



2-3



Thule RaceWay 991/992

Revolucionario.

- » Cables de trinquete de acero Sure-Tight que proporcionan una fijación segura en el vehículo.
- » Los pomos FitDial patentados garantizan un "ajuste perfecto" en el vehículo.
- » Soportes de calidad con RDT (tecnología de amortiguación de carreteras) que aseguran la bicicleta y absorben a la vez los impactos de la carretera.
- » Almohadillas de goma moldeada que proporcionan una sujeción firme al vehículo y protegen de los arañazos.
- » Jaulas No-Sway patentadas que evitan el contacto entre las bicicletas o con el vehículo.
- » Brazos de soporte estrechos que admiten una gran variedad de cuadros en bicicleta, incluidas las bicis de niños pequeños, y que se pliegan cuando no se utilizan.
- » Se pliega y queda plano para un almacenamiento y un transporte sencillos.
- » Sistema antirrobo incluido.



Ref.: 991001 (2 bicis) · PVR: 332,15 €

Ref.: 992001 (3 bicis) · PVR: 363,55 €



Abrazadera



Detalle plegado

THULE



2-4



Thule BackPac 973

Extensible de montaje elevado en el portón trasero.

- » La posición elevada mantiene visibles las luces y la placa de matrícula del vehículo.
- » Kit especial que se adapta a distintos modelos de vehículos. Consultar.
- » Transporta dos bicicletas. Opcional extensiones para tres o cuatro bicicletas
- » Compatible con cuadros de 22-80 mm.
- » Soportes de ruedas extensibles.
- » Todas las partes en contacto con el vehículo y las bicicletas están revestidas de goma.
- » Disponible en un tamaño:
Thule BackPac Ref.: **973002** · PVR: **318,93 €**
- » Opcional:
Sistema antirrobo Ref.: **567000** · PVR: **22,23 €**
Kit de adaptación Ref.: **973-1*** · PVR: **47,11 €**



¿Necesitas transportar 1 o 2 bicicletas más? Añade los adaptadores:

Adaptador Thule 973-23:
el BackPac pasa de 2 a 3 bicicletas.
Ref.: **973231** · PVR: **103,22 €**

Adaptador Thule 973-24:
el BackPac pasa de 3 a 4 bicicletas.
Ref.: **973241** · PVR: **103,22 €**



Posición elevada



Original abrazadera del cuadro desmontable



Correas de colocación rápida

THULE



2-4
NEW

Thule WanderWay 911

El portabicicletas perfecto para el VW T6

- » La posición elevada mantiene visibles las luces y la placa de matrícula del vehículo.
- » Diseñado especialmente para VW T6
- » Transporta dos bicicletas. Opcional extensiones para tres o cuatro bicicletas.
- » Compatible con cuadros de 22-80 mm.
- » Soportes de ruedas ajustables.
- » Todas las partes en contacto con el vehículo y las bicicletas están revestidas de goma.
- » Ruedas hasta 3"

Ref.: 911001 · PVR: 446,20 €



Si quieres transportar 3 o 4 bicicletas, añade los adaptadores:

Adaptador Thule 911-6:
pasa de 2 a 3 bicicletas.
Ref.: 911600 · PVR: 89,17 €

Adaptador Thule 911-7:
pasa de 3 a 4 bicicletas.
Ref.: 911700 · PVR: 89,17 €



Se puede plegar de forma vertical cuando no se utiliza



Permite la apertura del maletero (sin bicicletas)



Posición elevada



Original abrazadera del cuadro desmontable



Correas y Carriles ajustables

THULE

Portabicicletas de techo



Nombre	Thule UpRide	Thule ThruRide	Thule OutRide	Thule ProRide	Thule ProRide	Thule FreeRide
Modelo	599	565	561	598	598 Black	532
Precio (€)	181,74	180,08	130,50	115,62	130,50	64,42
Capacidad de carga	20 kg	17 kg	17 kg	20 kg	20 kg	17 kg
Dimensiones (l x a x x)	163x31,5x10,5	135x15x10 cm	137x22x8 cm	145x32x9 cm	145x32x9 cm	145x21x8 cm
Peso del producto	7,7 kg	2,7 kg	2,5 kg	4,2 kg	4,2 kg	3,5 kg
Compatible con Thru Axle	Todos	12-20 mm	20mm incluido 15x100 con accesorio 5611 15x110 con accesorio 5612 12x110 con accesorio 5613	Todos	Todos	Todos
Se adapta a ruedas de tamaño	Hasta 3" 3"-5" con accesorio 5991	Hasta 3"	Hasta 3"	Hasta 3" (3-5" con accesorio 5981)	Hasta 3" (3-5" con accesorio 5981)	Hasta 3"
Para cuadros con dimensiones	Todos	Todos	Todos	Cuadro redondo de 22 a 80 mm Cuadro ovalado máx. 80x100 mm	Cuadro redondo de 22 a 80 mm Cuadro ovalado máx. 80x100 mm	Cuadro redondo de 22 a 70 mm Cuadro ovalado máx. 65x80 mm
Barras con rail de 20x20 mm	•	•	•	•	•	•
Barras con rail de 24x30 mm	Accesorio 8881	Accesorio 8894	Accesorio 8893	Accesorio 8891	Accesorio 8891	Accesorio 8893
Barras de sección cuadrada	Accesorio 8888		•	Accesorio 8895	Accesorio 8895	•
Compatible con sistema One-Key	•	•	•	•	•	•
Seguridad con llave	•	•	•	•	•	•
Homologación TÜV	•	•	•	•	•	•
Cumple la norma CityCrash	•	•	•	•	•	•

Portabicicletas de bola de remolque



Nombre	Thule EasyFold		Thule VeloSpace XT		Thule VeloCompact	
	933 / 933 B	934 / 934 B	938 / 938 B	939 / 939 B	924 / 925	926 / 927
Precio (€)	661,12 / 707,36	752,85 / 788,35	531,32 / 574,30	617,27 / 659,55	461,07 / 367,69	562,73 / 470,99
Max. número bicicletas	2	3	2	3	2	3 (4 con accesorio 9261)
Capacidad de carga (kg)	60 kg	60 kg	60 kg	60 kg	46 kg	60 kg
Peso máx. bicicleta (kg)	30 kg	30 kg	30 kg	30 kg	25 kg	25 kg
Dimensiones (l x a x x a cm)	123x63x68 (31x63x68 cm plegado)	123x83x86 (31x83x86 cm plegado)	135x69x79 (135x74x25 cm arco plegado)	135x73x79 (135x73x31 cm arco plegado)	130x56x76 (106x66x30 cm arco plegado)	126x74x80 (103x74x35 cm arco plegado)
Peso (kg)	17,9 kg	23,1 kg	18,7 kg	20,6 kg	14,1 kg	18,9 kg
Cuadros con dimensiones:	22-80 mm		22-80 mm		22-80 mm	
Abrazaderas de cuadro desmontables	•		•		•	
Distancia entre ruedas	22 cm	22/19 cm	25 cm	19 cm	19 cm	
Soportes de rueda ajustables	Hebillas de apertura rápida		Hebillas de apertura rápida		Hebillas de apertura rápida	
Función inclinable con bicicletas	Pedal		Pedal		Pedal	
Rampa de carga	Sí, con accesorio 9334		Sí, con accesorio 9172		Sí, con accesorio 9152	
Coches con rueda de repuesto exterior			Sí, con accesorio 939400		Sí, con accesorio 9241	
Luces traseras	•		•		•	
Conector de alimentación	13p (7p con adaptador 768009)		13p (7p con adaptador 768009)		13p / 7p	13p / 7p
Homologación TÜV	•		•		•	
Cumple con la norma City Crash	•		•		•	
Sistema de seguridad con llave	•		•		•	

THULE

Portabicicletas de portón trasero



Nombre	Thule RaceWay		Thule WanderWay2	Thule BackPac	Thule ClipOn High		Thule ClipOn		Thule FreeWay
	991	992	911	973	9105	9106	9103	9104	968
Precio (€)	332,15	363,55	446,20	318,93	278,43	278,43	148,68	148,68	105,70
Máx. número de bicicletas	2	3	2 3 con adaptador 9116 4 con adaptador 9117	2 3 con adaptador 97323, 4 con adaptador 97323 + 97324	2	2	3	3	3
Capacidad de carga (kg)	30 kg	45 kg	60 kg	60 kg	30 kg	30 kg	45 kg	45 kg	45 kg
Peso (kg)	10 kg	10,6 kg	30 kg	15 kg	11,5 kg	12,5 kg	6,1 kg	7,1 kg	5,1 kg
Montaje del portabicicletas	Cables de acero con trinquete			Con kit BackPac	Sistema de montaje "snap-on"		Sistema de montaje "snap-on"		Correas ajustables
Se adapta a cuadros de tamaño	Todos		22-80 mm	22-80 mm	22-80 mm		Todos		Todos
Se adapta a ruedas de tamaño	Todos		Hasta 3"	Hasta 3"	Hasta 3"		Todos		Todos
Abrazadera de cuadro con revestimiento de goma	•	•	•	•	•	•	•	•	•
Abrazaderas de cuadro desmontables			•	•	•	•			
Colocación de la rueda en soportes ajustables			Correas ajustables	Correas ajustables	Correas ajustables				
Bloquea la bici al portabicicletas	•	•	•	•	•	•	Accesorio 538		Accesorio 538
Bloquea el portabicicletas al automóvil	•	•		Accesorio 567					
Acceso al maletero con el portabicicletas montado	•	•		•	•	•	•	•	•
Normas City Crash	•	•	•	•	•	•	•	•	•
Varios	Premontado. Se incluye una resistente correa para fijar las bicicletas.		Específico VW T6 Instalación que no oculta las luces traseras ni la placa	Instalación que no oculta las luces traseras ni la placa de matrícula. Según vehículo	Instalación que no oculta las luces traseras ni la placa de matrícula. Disponible una tercera luz de frenos 9902. Según vehículo		Fácil de montar con flexibilidad de apriete. Se incluye una resistente correa para fijar las bicicletas.		Se incluye una resistente correa para fijar las bicicletas. Apto también para automóviles sedán.

Consulta la guía Thule o www.thule.com para obtener información acerca de la instalación en distintos modelos de coche.



Nombre	Thule EuroRide		Thule RideOn		Thule HangOn			Thule Express
	941	943	9502	9503	972	974	9708	970
Precio (€)	310,66	380,91	238,76	269,34	1179,75	104,05	150,33	66,86
Max. número bicicletas	2	3	2	3	3	3	4	2
Capacidad de carga (kg)	36 kg	45 kg	30 kg	45 kg	45 kg	45 kg	45 kg	30 kg
Peso máx. bicicleta (kg)	20 kg	20 kg	15 kg	15 kg	15 kg	15 kg	15 kg	15 kg
Dimensiones (l x a x a cm)	105x58x75 (105x67x25 cm arco plegado)	105x75x75 (105x75x25 cm arco plegado)*	106x57x70 (106x57x25 cm arco plegado)	106x77x70 (106x77x25 cm arco plegado)	48x55x77 (48x16x81 cm plegado)	47x54x76 (47x20x81 cm plegado)	47x64x90 (43x32x84 cm plegado)	52x35x74 (52x14x72 cm plegado)
Peso (kg)	14 kg	17 kg	9 kg	12 kg	7,2 kg	7,2 kg	10,3 kg	4,3 kg
Cuadros con dimensiones:	20-70 mm		Todos		desde 20"			desde 20"
Abrazaderas de cuadro desmontables								
Distancia entre ruedas	17 cm	17 cm	19 cm	19 cm				
Soportes de rueda ajustables	Correas ajustables		Correas ajustables					
Función inclinable con bicicletas	Accionado con la mano		Accionado con la mano		Manual		Manual	
Rampa de carga								
Coches con rueda de repuesto exterior								
Luces traseras	•	•	•	•	Sí, con accesorio 976			Sí, con accesorio 976
Conector de alimentación	7p (13p con 768019)		7p (13p con 768019)					
Homologación TÜV								
Cumple con la norma City Crash	•		•		•			•
Sistema de seguridad con llave	Sí, con accesorio 526/527/528		Sí, con accesorio 538/957		Sí, con accesorio 538/957			Sí, con accesorio 538 + candado





Thule Vector

NEW

El cofre portaequipajes premium

- » Diseño elegante y deportivo con integración perfecta de la tapa y la base.
- » Sistema de montaje sobre las barras de techo rápido y seguro gracias al sistema PowerClick con indicador de apriete.
- » Sistema de apertura de la tapa DualSide.
- » Sistema SlideLock con bloqueo y apertura separados.
- » Interior de la tapa de color blanco combinado con una luz LED.
- » Base interior revestida de fieltro.
- » Acceso total al maletero del vehículo.
- » Incluye funda Thule Box Lid Cover para proteger el cofre durante su almacenamiento.



PowerClick



DualSide



SideLock



Thule Vector L. Tamaño: 231,5x88,5x35,5 cm

■ Ref. 613700 · PVR: 1.372,64 €

■ Ref. 613701 · PVR: 1.372,64 €

Thule Vector M. Tamaño: 212x88x33 cm

■ Ref. 613200 · PVR: 1.329,67 €

■ Ref. 613201 · PVR: 1.329,67 €

Thule Vector Alpine. Tamaño: 228x88,5x32 cm

■ Ref. 613500 · PVR: 1.372,64 €

■ Ref. 613501 · PVR: 1.372,64 €



THULE



Thule Motion XT

Espacioso, elegante y optimizado.

- » Espacioso y con diseño aerodinámico, con más capacidad y mayor aprovechamiento del espacio.
- » Sistema de montaje PowerClick preinstalado.
- » Sistema de apertura DualSide para facilitar el montaje, la carga y la descarga.
- » Sistema de cierre de seguridad SlideLock, cierre automático de la tapa con indicador.
- » Asas exteriores para una cómoda apertura y cierre.



Power-Click



Dual-Side



SlideLock



Cierre centralizado

Thule Motion XT XXL. Tamaño: 235 x 95 x 47 cm



■ Ref. 629900 · PVR: 802,40 €
■ Ref. 629901 · PVR: 802,40 €

Thule Motion XT ALPINE. Tamaño: 232 x 95 x 35 cm



■ Ref. 629500 · PVR: 798,26 €
■ Ref. 629501 · PVR: 798,26 €

Thule Motion XT XL. Tamaño: 215 x 91,5 x 44 cm



■ Ref. 629800 · PVR: 636,28 €
■ Ref. 629801 · PVR: 636,28 €

Thule Motion XT Sport. Tamaño: 189 x 67,5 x 43 cm



■ Ref. 629600 · PVR: 507,36 €
■ Ref. 629601 · PVR: 507,36 €

Thule Motion XT L. Tamaño: 195 x 91,5 x 43 cm



■ Ref. 629700 · PVR: 591,65 €
■ Ref. 629701 · PVR: 591,65 €

Thule Motion XT M. Tamaño: 175 x 86,5 x 46 cm



■ Ref. 629200 · PVR: 552,81 €
■ Ref. 629201 · PVR: 552,81 €



Thule Force XT

Para viajeros activos todos los días del año.

- » Fabricado con material AeroSkin texturado.
- » Sistema de montaje rápido PowerClick con indicador de apriete.
- » Cerradura LockKnob centralizada y con protección.
- » Sistema de apertura DualSide.



Refuerzo interior



Dual-Side

NEW



PowerClick



Cerradura LockKnob

Thule Force XT XL. Tamaño 210 x 86 x 44 cm



Ref. 635800 · PVR: 540,41 €

Thule Force XT Alpine. Tamaño 230 x 70 x 42,5 cm



Ref. 635500 · PVR: 540,41 €

Thule Force XT L. Tamaño: 190 x 84 x 46 cm



Ref. 635700 · PVR: 501,57 €

Thule Force XT M. Tamaño: 175 x 82 x 45,5 cm



Ref. 635200 · PVR: 461,90 €

Thule Force XT Sport. Tamaño: 190 x 63 x 42,5 cm



Ref. 635600 · PVR: 421,40 €

Thule Force XT S. Tamaño: 139 x 89,5 x 39 cm



Ref. 635100 · PVR: 380,08 €

THULE



Thule Touring

El cofre funcional para todo tipo de aplicaciones.

- » Nuevo material especial texturado para la tapa, que le confiere un aspecto lujoso.
- » Sistema de montaje patentado FastClick que permite una instalación rápida y segura con una sola mano.
- » Sistema de apertura DualSide .
- » Sistema CentralLocking, máxima seguridad.



FastClick



Dual-Side



Cierre centralizado

Thule Touring L. Tamaño 196 x 78 x 43 cm



Ref. 634800 · PVR: 413,14 €

Thule Touring M. Tamaño: 175 x 82 x 45 cm



Ref. 634200 · PVR: 380,08 €

Cofres porta equipajes



Nombre	Thule Vector L	Thule Vector M	Thule Vector Alpine	Thule Motion XT XXL	Thule Motion XT XL	Thule Motion XT L	Thule Motion XT M	Thule Motion XT Sport	Thule Motion XT Alpine
Precio (€)	1372,64	1.329,67	1.372,64	802,40	636,28	591,65	552,81	507,36	798,26
Número SKU	6137B Negro metalizado	6132B Negro brillante	6135B Negro brillante	6299B Negro brillante	6298B Negro brillante	6297B Negro brillante	6292B Negro brillante	6296B Negro brillante	6295B Negro brillante
Color	6137T Titanio	6132T Titanio brillante	6135T Titanio brillante	6299T Titanio brillante	6298T Titanio brillante	6297T Titanio brillante	6292T Titanio brillante	6296T Titanio brillante	6295T Titanio brillante
Capacidad	430 l	360 l	380 l	450 l	610 l	500 l	450 l	400 l	300 l
Dimensiones (l x a x a)	231,5 x 88,5 x 35,5 cm	212 x 88 x 33 cm	228 x 88,4 x 32 cm	232 x 95 x 35 cm	232 x 95 x 47 cm	215 x 91,5 x 44 cm	195 x 89 x 44 cm	175 x 86,5 x 46 cm	189 x 67,6 x 43 cm
Dimensiones internas (l x a x a)	204,5 x 78 x 32,5	186 x 78 x 29,5	204,5 x 78 x 28	222 x 85 x 30	222 x 84 x 41	200 x 80 x 38	182 x 80 x 36	164 x 76 x 40	177 x 57 x 37
Capacidad de carga	75 kg	75 kg	75 kg	75 kg	75 kg	75 kg	75 kg	75 kg	75 kg
Peso del producto	30 kg	29 kg	30 kg	25 kg	25,5 kg	23,5 kg	20 kg	17,5 kg	16 kg
Sistema de montaje	PowerClick	PowerClick		PowerClick					
Sistema de bloqueo	SlideLock	SlideLock		SlideLock					
Apertura de cofre	DualSide	DualSide		DualSide					
Capacidad de carga Esquíes	4-6	3-5	4-6	5-7	5-7	5-7	5-7	4-6	3-5
Capacidad de carga Snowboards	3-5	3-4	3-5	3-5	3-5	3-5	3-5	3-4	3-4
Longitud máxima de los esquís	205 cm	185 cm	200 cm	215 cm	215 cm	200 cm	180 cm	155 cm	175 cm
Portaesquíes	Sí	Sí	Sí	Sí, con adaptador 6949	Sí, con adaptador 6949	Sí, con adaptador 6949	Sí, con adaptador 6948	Sí, con adaptador 6948	Sí, con adaptador 6946
Se acopla a Thule WingBar Evo	•	•	•	•	•	•	•	•	•
Para Thule SlideBar	Sí, con adaptador 6976			Sí, con adaptador 6976					
Se adapta a Thule SquareBar	•	•	•	•	•	•	•	•	•
Homologación TÜV/GS	•	•	•	•	•	•	•	•	•
Cumple la norma City Crash	•	•	•	•	•	•	•	•	•

Cofres portaequipajes plegables



Nombre	Thule Ranger	
	90	500
Precio (€)	297,44	353,64 €
Número SKU	6011	6035
Color	Negro/plata	Negro/plata
Capacidad	280 l	260 l
Dimensiones (l x a x a) ¹	110 x 80 x 40 cm	190 x 50 x 30 cm
Capacidad de carga	50 kg	50 kg
Peso del producto	7 kg	11 kg
Sistema de montaje	Easy-Snap	Easy-Snap
Apertura de cofre	Un lado	Un lado
Plegable, para facilitar su almacenamiento	•	•
Cierre centralizado	•	•
Capacidad de carga Esquíes		3-4
Capacidad de carga Snowboards		2-3
Longitud máxima de los esquís		185 cm
Portaesquíes		
Se acopla a Thule Wingbar Evo	•	•
Para Thule SlideBar	Sí, con adaptador 697-1	Sí, con adaptador 697-1
Se adapta a Thule SquareBar	•	•
Homologación TÜV/GS	•	•
Cumple la norma City Crash	•	•

¹Medidas interiores del producto basadas en planos de ingeniería 3D digitalizados.



Nombre	Thule Force XT Alpine	Thule Force XT XL	Thule Force XT L	Thule Force XT M	Thule Force XT S	Thule Force XT Sport	Thule Touring L	Thule Touring M
Precio (€)	540,41	540,41	501,57	461,90	380,08	421,40	413,14	380,08
Número SKU	6355B	6358B	6357B	6352B	6351B	6356B	6348T	6342T
Color	Negro texturado	Negro texturado	Negro texturado	Negro texturado	Negro texturado	Negro texturado	Titanio texturado	Titanio texturado
Capacidad	420 l	500 l	450 l	400 l	300 l	300 l	420 l	400 l
Dimensiones (l x a x a)	230 x 70 x 42,5 cm	210 x 86 x 44 cm	190 x 84 x 46 cm	175 x 82 x 45,5 cm	139 x 89,5 x 39 cm	190 x 63 x 42,5 cm	196 x 78 x 43 cm	175 x 82 x 45 cm
Dimensiones internas (l x a x a)	218 x 59 x 37	197 x 75 x 39	177 x 73 x 41	162 x 71 x 40	127 x 78 x 34	179 x 52 x 37	190 x 73 x 39	170 x 77 39
Capacidad de carga	75 kg	75 kg	75 kg	75 kg	75 kg	75 kg	50 kg	50 kg
Peso del producto	19,4 kg	21,3 kg	18,7 kg	16,4 kg	14,3 kg	14,7 kg	15 kg	13 kg
Sistema de montaje	PowerClick						FastClick	
Sistema de bloqueo	SlideLock						Cierre centralizado	
Apertura de cofre	DualSide						DualSide	
Capacidad de carga Esquíes	3-5	5-7	5-7	4-6	N/D	3-5	4-6	4-6
Capacidad de carga Snowboards	3-4	3-5	3-5	3-4	N/D	3-4	3-4	3-4
Longitud máxima de los esquís	215 cm	195 cm	175 cm	155 cm	-	175 cm	180 cm	155 cm
Portaesquíes	Sí, con adaptador 6947	Sí, con adaptador 6948	Sí, con adaptador 6948	Sí, con adaptador 6948	-	Sí, con adaptador 6945	Sí, con adaptador 6948	Sí, con adaptador 6948
Se acopla a Thule WingBar Evo	•	•	•	•	•	•	•	•
Para Thule SlideBar	Sí, con adaptador 6976						Sí, con adaptador 6974	
Se adapta a Thule SquareBar	•	•	•	•	•	•	•	•
Homologación TÜV/GS	•	•	•	•	•	•	•	•
Cumple la norma City Crash	•	•	•	•	•	•	•	•





Cruz Box

- » Diseño funcional para montaje sobre barras.
- » Excelente capacidad de carga.
- » Apertura lateral asistida (lado derecho).
- » Cierre centralizado.
- » Correas interiores para fijación de la carga.
- » Compatible con todos los modelos de barras.
- » Color Negro Brillo.



CruzBox 340N



Negro Ref. [940466U](#) · PVR: **181,78 €**

CruzBox 430N



Negro Ref. [940467U](#) · PVR: **239,63 €**

CruzBox Road							
Cruz Box 340N Ref. 940466U	•	140x80x45 cm	340 L	•	15 kg	max. 75 kg	
Cruz Box 430N Ref. 940467U	•	175x80x45 cm	430 L	•	19 kg	max. 75 kg	



Cruz Easy

- » Diseño aerodinámico y gran capacidad de carga.
- » Apertura lateral asistida (lado derecho).
- » Sistema de seguridad frontal.
- » Cerraduras antirrobo.
- » Colores: Antracita y gris.

CruzBox Easy 320GM / 320A



Gris. Ref. 940343U · PVR: 165,25€
Antracita. Ref. 940460U · PVR: 173,51 €

CruzBox Easy 420GM / 420A



Gris. Ref. 940345U · PVR: 214,84 €
Antracita. Ref. 940461U · PVR: 231,36 €



CruzBox Easy 430GM / 430A



Gris. Ref. 940348U · PVR: 214,84 €
Antracita. Ref. 940462U · PVR: 231,36 €

CruzBox Easy 480GM / 480A



Gris. Ref. 940350U · PVR: 247,89 €
Antracita. Ref. 940463U · PVR: 256,11 €

CruzBox Easy



CruzBox Easy 320GM Ref. 940343U	•	132x75x36 cm	320 L	•	10 kg	max. 50 kg
CruzBox Easy 320A Ref. 940460U	•	132x75x36 cm	320 L	•	10 kg	max. 50 kg
CruzBox Easy 420GM Ref. 940345U	•	145x94x40 cm	420 L	•	14 kg	max. 50 kg
CruzBox Easy 420A Ref. 940461U	•	145x94x40 cm	420 L	•	14 kg	max. 50 kg
CruzBox Easy 430GM Ref. 940348U	•	180x78x40 cm	430 L	•	14 kg	max. 50 kg
CruzBox Easy 430A Ref. 940462U	•	180x78x40 cm	430 L	•	14 kg	max. 50 kg
CruzBox Easy 480GM Ref. 940350U	•	198x78x40 cm	480 L	•	18 kg	max. 50 kg
CruzBox Easy 480A Ref. 940463U	•	198x78x40 cm	480 L	•	18 kg	max. 50 kg



Cruz Road

- » Diseño deportivo aerodinámico y gran capacidad de carga.
- » Apertura lateral asistida (lado derecho).
- » Montaje Ultrarapid 85.
- » Cerraduras antirrobo.
- » Correas interiores para fijación de la carga.
- » Colores: negro texturizado y gris texturizado.
- » Distancia entre barras 66 - 108 cm.

CruzBox Road 370



Gris. Road 370GT
Negro. Road 370NT

Ref. 940470 · PVR: 223,10 €
Ref. 940471 · PVR: 223,10 €



Sistema Ultrarapid 85



Antirrobo

CruzBox Road 460



Gris. Road 460GT
Negro. Road 460GT

Ref. 940472 · PVR: 289,22 €
Ref. 940473 · PVR: 289,22 €

CruzBox Road							
CruzBox Road 370GT Ref. 940470	•	•	140x90x38 cm	370 L	•	16 kg	max. 75 kg
CruzBox Road 370NT Ref. 940471	•	•	140x90x38 cm	370 L	•	16 kg	max. 75 kg
CruzBox Road 460GT Ref. 940472	•	•	185x80x41 cm	460 L	•	18 kg	max. 75 kg
CruzBox Road 460NT Ref. 940473	•	•	185x80x41 cm	460 L	•	18 kg	max. 75 kg



Cruz Paddock

- » Exclusividad y elegancia.
- » Apertura bilateral.
- » Cierre centralizado con seguridad.
- » Correas interiores para fijación de la carga.
- » Compatible con todas las barras Cruz.
- » Colores: negro texturizado, gris texturizado.
- » Fabricado en ABS.



Apertura Dual



Montaje Quick 80



Gris. Paddock 450G
Negro. Paddock 450N

Ref. 940482 · PVR: 388,39 €
Ref. 940483 · PVR: 388,39 €



Gris. Paddock 500G
Negro. Paddock 500N

Ref. 940486 · PVR: 413,18 €
Ref. 940487 · PVR: 413,18 €



Negro texturado 450NT

Ref. 940495 · PVR: 454,50 €

CruzBox Paddock

CruzBox Paddock 450G Ref. 940482	•		175x82x44 cm	450 L	•	14,4 kg	max. 75 kg
CruzBox Paddock 450N Ref. 940483	•		175x82x44 cm	450 L	•	14,4 kg	max. 75 kg
CruzBox Paddock 500G Ref. 940486	•		200x80x40 cm	500 L	•	16,2 kg	max. 75 kg
CruzBox Paddock 500N Ref. 940487	•		200x80x40 cm	500 L	•	16,2 kg	max. 75 kg
CruzBox Paddock 450NT Ref. 940495	•		175x82x44 cm	450 L	•	14,4 kg	max. 75 kg



Thule Ranger

Solución plegable y fácil de almacenar.

- » Muy fácil de guardar: se pliega hasta un pequeño tamaño que cabe en el maletero.
- » Sistema de montaje rápido Easy-Snap que facilita el acoplamiento del cofre sin herramientas.
- » Fabricado en material impermeable, con costuras selladas y un cremallera sellada con cerradura integrada.
- » Incluye una bolsa especial para guardar el cofre plegado (Thule Ranger 90).
- » Capacidad de carga de hasta 50 kg
- » Zonas de fuelle con cremalleras para ajustar el espacio al tamaño de la carga (Thule Ranger 500).
- » Se incluyen portaesquíes para el transporte seguro de esquís (Thule Ranger 500).



Bolsa especial
para Thule Ranger 90



Portaesquíes
para Thule Ranger 500



Thule Ranger 90.
Volumen: 340 litros.
Tamaño: 110 x 80 x 40 cm.
Ref. 601100 · PVR: 297,44 €



Easy Snap
Sistema de cierre rápido



Thule Ranger 500.
Volumen: 300 litros.
Tamaño: 190 x 50 x 30 cm.
Ref. 601100 · PVR: 353,64 €



Fácil de guardar
Thule Ranger ocupa muy poco espacio, puedes guardarlo hasta en un armario.



Llévalo bajo el brazo
Lleva el cofre a donde quieras en la bolsa de diseño especial.



Desplégalo
No tienes más que ponerlo en el portaequipajes, desplegarlo y montarlo, ¡así de fácil!



Thule Trail 823/824

La baca de calidad superior con funciones integradas

- » Diseñado exclusivamente en color aluminio plateado con elementos negros de contraste.
- » Consolas laterales integradas para mayor seguridad.
- » Guías T integradas para un perfecto acoplamiento de otros productos de Thule.
- » Recubrimiento de goma antideslizante para cargar objetos largos.
- » Se puede bloquear en la barra de techo.
- » Puntos de acoplamiento ajustables a la barra de techo en longitud.

Thule Trail M

Ref.: **823000** · PVR: **582,56 €**

Ref.: **823006** · PVR: **602,40 €** (Black)

Thule Trail L

Ref.: **824000** · PVR: **715,62 €**

Ref.: **824001** · PVR: **741,24 €** (Black)



Thule EasyBase 949

Flexible solución de transporte de cuatro funciones.

- » Plataforma hecha de robustos tubos metálicos.
- » Acoplamiento patentado. Encaja en todo tipo de bolas de remolque y no precisa reajuste.
- » La barra en U puede plegarse fácilmente al almacenarla.
- » Puede ampliarse con accesorios Thule EasyBase.
- » Capacidad de carga de 45 kg.

Ref.: **949008** · PVR: **251,98 €**

Adáptalo a tus necesidades.



Thule BackUp 900

Se monta fácilmente a mano en Thule EasyBase sin necesidad de herramientas. Perfecto si desea utilizar el techo del vehículo para otras cargas o si desea transportar objetos voluminosos que requieren protección.

Ref. **900000** · PVR: **509,01 €**

Bacas	Thule Trail	
	823 / 823 B	824 / 824 B
Precio (€)	582,56/602,40	715,62/741,24
Tamaño (cm)	135 x 90 x 18	160 x 100 x 18
Cerradura	•	•
Se adapta a WingBar Edge	•	•
Se adapta a WingBar	•	•
Se adapta a SlideBar	•	•
Se adapta a barras de sección cuadrada	•	•
Homologación TÜV/GS	•	•
Cumple las normas City Crash	•	•
Varios	Aluminio. Los puntos de acoplamiento se ajustan a las barras de techo en longitud.	

Sistemas portacargas traseros	Thule EasyBase	Thule BackUp
	949	900
Precio (€)	251,98	509,01
Tamaño (cm)	120 x 60 x 78	147 x 57 x 70
Máx. número de bicicletas		
Capacidad de carga (kg)	45	50
Peso (kg)	15	14
Homologación TÜV/EuroBE	•	•
Cumple las normas City Crash	•	•
Varios	Luces traseras. Fija la base al automóvil con el accesorio 957. 7 polos (13 polos con adaptador 768019)	Volumen de 420 litros. Apertura trasera. Sistema de montaje de perno en U de 80 mm. Color gris.

THULE



Thule SnowPack Extender 7325

Extensible, de gran capacidad

- » Extensible, para facilitar la carga y descarga.
- » Diseñado para transportar 5 pares de esquís o 2 tablas de snowboard.
- » Protecciones de goma ultra suaves que agarran sin dañar las superficies.
- » Pulsador de gran tamaño.
- » Diseño elevado para evitar el contacto con el techo del vehículo.
- » Se acopla directamente a los perfiles en T de las barras (accesorio opcional para su montaje sobre barras de perfil cuadrado Ref.: 889700 · PVR: 14,01 €)

Ref.: 732500 · PVR 234,63 €

Ref.: 732507B · PVR 259,42 € (Black)



Detalle del sistema extensible

Portaequipajes para deportes de invierno

Nombre	Thule SkiClick	Thule SnowPack Extender	Thule SnowPack				
	7291	7325 / 7325 B	7322	7324	7324B	7326	7326B
Precio	47,85	234,63 / 259,42	136,28	151,16	166,03	203,22	223,06
Capacidad de carga	7 kg	35 kg	14 kg	28 kg		42 kg	
Capacidad de carga Esquí	1 par (esquí de fondo)	Hasta 5 pares	Hasta 2 pares	Hasta 4 pares		Hasta 6 pares	
Capacidad de carga Snowboards		Hasta 2 tablas	1 tabla	Hasta 2 tablas		Hasta 2 tablas	
Dimensiones (l x a x a)	11 x 9 x 9 cm	77,5 x 7 x 14 cm	37 x 7 x 14 cm	62 x 7 x 10 cm		87 x 7 x 10 cm	
Peso del producto	0,4 kg	5,4 kg	2,8 kg	3,8 kg		4,8 kg	
Ancho de carga		62,5 cm	25 cm	50 cm		75 cm	
Botón pulsador extragrande		•	•	•		•	
Espacio para fijaciones altas		•	•	•		•	
Para barras de techo con raíles de 20x20 mm	•	•	•	•		•	
Para barras de techo con raíles de 24x30 mm		Sí, con accesorio 889-6	Sí, con accesorio 889-6	Sí, con accesorio 889-6		Sí, con accesorio 889-6	
Para barras de techo con sección cuadrada	•	Sí, con accesorio 8897	Sí, con accesorio 8897	Sí, con accesorio 8897		Sí, con accesorio 8897	

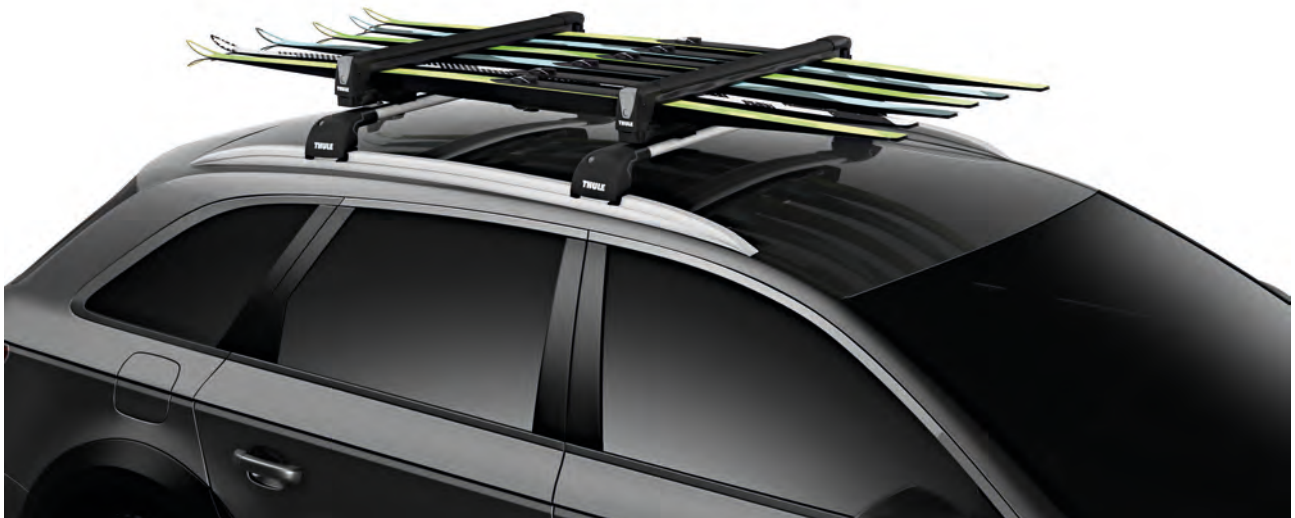

Thule SnowPack / SnowPack Black

Innovador

- » Diseñado para transportar de 2 a 6 pares de esquís o hasta 4 tablas de snowboard.
- » Protecciones de goma ultra suaves que agarran sin dañar las superficies.
- » Pulsador de gran tamaño.
- » Diseño elevado para evitar el contacto con el techo del vehículo.
- » Se acopla directamente a los perfiles en T de las barras (accesorio opcional para su montaje sobre barras de perfil cuadrado Ref.: 889700 · PVR: 14,01 €)

S (2 pares) Ref.: **7322** · PVR: **136,28 €**

M (4 pares) Ref.: **7324** · PVR: **151,16 €**

M (4 pares) Ref.: **7324B** · PVR: **166,03 €** (Black)

L (6 pares) Ref.: **7326** · PVR: **203,22 €**

L (6 pares) Ref.: **7326B** · PVR: **223,06 €** (Black)



Tacos de elevación incluidos



Thule SkiClick

Para esquís de fondo

- » Diseño inteligente que ahorra espacio.
- » Mínima resistencia al viento.
- » Solución 3 en uno, incorpora correa para esquís que se puede colgar en la pared.



Fijación Pared
Ref. 729300 · PVR: 14,79 €



Bolsa SkiClick
Ref. 729400 · PVR: 23,88 €
Acoplamiento sin ajustes previos



Bolsa SkiClick
Ref. 729500 · PVR: 35,45 €

Ref.: **7291** · Thule SkiClick 1 par · PVR: **47,85 €**

CRUZ



Cruz Ski-Rack Dark

- » Montaje sobre barras de techo.
- » Incluye adaptadores para barras de acero y aluminio.
- » Sistema antirrobo incluido.
- » Ski-Rack 4: 4 pares de esquís o 2 tablas de snow.
- » Ski-Rack 6: 6 pares de esquís o 4 tablas de snow.

Ski-Rack Dark 4 Ref.: **940222** · PVR: **74,95 €**

Ski-Rack Dark 6 Ref.: **940223** · PVR: **84,95 €**



Cruz Aconcagua

- » Magnético.
- » 3 pares de esquís o 2 tablas de snow.
- » Montaje sin herramientas.
- » Incluido antirrobo.

Ref.: **940293** · PVR: **119,95 €**





Autosock

Es una funda textil que se coloca en las ruedas motrices del vehículo cuando se necesita una mayor adherencia en carreteras con nieve o hielo. Son las únicas cadenas textiles con la certificación TÜV 53219 que certifican su seguridad y las prestaciones del producto como una ayuda para la tracción en situaciones de emergencia durante el invierno. Autosock es una cadena textil aprobada por los principales fabricantes de automóviles.

- » La solución más sencilla para maximizar el agarre en nieve y hielo.
- » Rápido y sencillo de montar y retirar.
- » Reutilizable y lavable a máquina.
- » Cómo de almacenar.
- » Silencioso durante su uso.
- » Reciclable y respetuoso con el medioambiente.



Referencia	PVR
540	51,90 €
600	60,70 €
645	69,50 €
685	73,90 €
695	77,90 €
697	77,90 €
698	77,90 €
830	99,60 €
850	104,90 €
870	113,30 €





Thule Hullavator Pro 898



Thule K-Guard 840



Thule Hull-a-Port Aero 849

Thule Hull-a-Port XT 848

Thule DockGrip 895

Portaequipajes para deportes acuáticos



Nombre	Thule K-Guard	Thule Hullavator Pro	Thule Hull-a-Port Aero	Thule Hull-a-Port XT	Thule DockGrip	Thule DockGlide
Precio (€)	840	898	849	848	895	896
Precio (€)	241,24	675,95	257,77	217,27	142,89	170,99
Tipo de carga principal	Kayak	Kayak	Kayak	Kayak	Kayak	Kayak
Capacidad de carga	1 Kayak (máx 45 kg)	1 kayak (máx 35 kg)	1 kayak (máx. 34 kg)	1 kayak (máx. 59 kg)	1 kayak (máx. 40 kg)	1 kayak (máx. 35 kg)
Longitud de la correa (cm)	2 x 400 cm	1 x 275 cm	--	2 x 400	2 x 400	2 x 400
Protección de goma para hebilla	•	•	•	•	•	•
Para mástiles de cualquier dimensión						
Admite otras embarcaciones	Tabla de surf o embarcación pequeña				Tabla de surf o embarcación pequeña	Tabla de surf o embarcación pequeña
Cerradura	•	•	•	Accesorio 841	Accesorio 841	Accesorio 841
Se adapta a WingBar, SlideBar, AeroBar y ProBar	•	Solo Thule Pro-Bar	• ¹	WingBar	•	•
Se adapta a barras de sección cuadrada	•	•	Accesorio 889704	•	Accesorio 889704	Accesorio 889704
Homologación TÜV	•	•	•	•	•	•
Cumple norma City Crash	•	•	•	•	•	•
Compatible One Key System		•				
Varios		Transporte Horizontal				

¹ Instalación alrededor de las barras y en la ranura en T para Thule SlideBar con el adaptador 881. ² Instalación alrededor de las barras, no compatible con SlideBar.

³ Instalación alrededor de las barras y en la ranura en T para Thule WingBar, Thule SlideBar y Thule ProBar con el adaptador 882.



Thule DockGlide 896



Thule Portage 819



Cruz Porta Kayak Keel

Ref. 940620 · PVR: 74,95 €



Thule SUP Taxi XT



Thule Board Shuttle 811



Cruz Porta Kayak Rafter

Ref. 940622 · PVR: 89,95 €



Thule SurfPad 843/844



Thule SurfPad 845/846



Cruz Foam Azul

Referencia	Artículo	Precio
940600	Cruz Foam azul 42 cm	11,95 €
940601	Cruz Foam azul 61 cm	12,95 €
940602	Cruz Foam Azul Airo 42 cm	13,95 €
940603	Cruz Foam Azul Airo 61 cm	14,95 €



Thule Portage	Thule Sup Taxi XT	Thule Board Shuttle	Thule SurfPad			
819	810	811	843	844	845	846
114,01	300,74	180,12	36,28	44,55	36,28	44,55
Canoa	Soporte tabla surf/SUP	Soporte tabla surf/SUP	Tabla surf			
1 canoa (máx. 45 kg)	2 tablas (máx. 25 kg)	2 tablas (máx. 50 kg)	1 tabla			
2 x 440	2 x 240		--			
•		•				
Embarcación pequeña	Para todo tipo de tablas	Para todo tipo de tablas	Para todo tipo de tablas			
	•	Accesorio 841 o 538				
• ³	• ²	• ³	--			•
•	•	•	•			--
•	•	•				
			51 x 8 x 8 cm	76 x 8 x 8 cm	51 x 8 x 8 cm	76 x 8 x 8 cm

¹ Instalación alrededor de las barras y en la ranura en T para Thule SlideBar con el adaptador 881. ² Instalación alrededor de las barras, no compatible con SlideBar.

³ Instalación alrededor de las barras y en la ranura en T para Thule WingBar, Thule SlideBar y Thule ProBar con el adaptador 882.

Esquema de instalación de la Base de Enchufe.

Conexión 7 polos 12V (ISO 1724)

La conexión de 7 polos es la más utilizada para su uso con portabicicletas o remolques ligeros de hasta 750 kg. de MMR. Es conveniente limpiar de forma regular los orificios de salida de condensación para evitar un mal contacto de los conectores y la formación de óxidos en los mismos. Recuerde que existen adaptadores que pueden transformar esta conexión en una de 13 polos, pero siempre con las funciones específicas de un 7 polos.



Pin	Función	Color
1 / L	Intermitente izquierdo	Amarillo
2 / 54g	Antiniebla	Azul
3 / 31	Masa	Blanco
4 / R	Intermitente derecho	Verde
5 / 58R	Posición izquierda	Marrón
6 / 54	Freno	Rojo
7 / 58L	Posición derecha	Negro

Pin Opcional

2a	Desconexión luz antiniebla	Gris
----	----------------------------	------

Conexión 13 polos 12V (DIN 11446)

La conexión de trece polos es necesaria para conectar una caravana o un remolque de MMR mayor de 750 kg. En un caravana hay que considerar todos los accesorios incluidos, como la iluminación interior, el refrigerador y la carga de la batería auxiliar. Estos no podrían funcionar con un sistema de siete polos. El conector de 13 polos es hermético y tiene una larga duración. Los sellos de goma, por ejemplo, protegen el interior contra la humedad y la suciedad y cumple con los estrictos estándares DIN, el único sistema aprobado en la industria del automóvil. Recuerde que existen un adaptador que puede transformar su enchufe de 13 polos en un 7 polos.



Pin	Función	Color
1 / L	Intermitente izquierdo	Amarillo
2 / 54g	Antiniebla	Azul
3 / 31	Masa	Blanco
4 / R	Intermitente derecho	Verde
5 / 58R	Posición izquierda	Marrón
6 / 54	Freno	Rojo
7 / 58L	Posición derecha	Negro
8	Marcha atrás	Naranja
9	corriente de batería +30	Verde 2,5 mm
10	Corriente de contacto +15	Rojo 2,5 mm
11	Masa pin 10	Blanco
12	Reservado	Reservado
13	Masa pin 9	Blanco

Pin Opcional

14 / 2A	Desconexión luz antiniebla	Gris
---------	----------------------------	------

KITS ELÉCTRICOS BÁSICOS



7 polos PVC L=1500 mm Manguera independiente piloto izquierdo y derecho.
Ref. **766007** · PVR: **13,50 €**

7 polos PVC L=2000 mm Manguera independiente piloto izquierdo y derecho.
Ref. **766008** · PVR: **15,00 €**

7 polos ALU L=2000 mm Manguera independiente piloto izquierdo y derecho.
Ref. **766009** · PVR: **18,00 €**

13 polos PVC L=2000 mm Manguera independiente piloto izquierdo y derecho.
Ref. **766013** · PVR: **39,50 €**

13 polos PVC L=1900 mm Manguera independiente piloto izquierdo y derecho. 7 funciones + marcha atrás
Ref. **766014** · PVR: **29,00 €**

KITS ELÉCTRICOS UNIVERSALES CON CENTRALITA

7 polos con centralita. Con desconexión de antiniebla.
Ref. **766107** · PVR: **98,00 €**

NEW

13 polos con centralita. Con desconexión de antiniebla. 7 funciones + marcha atrás (no incluye cables de corriente y contacto)
Ref. **766213** · PVR: **110,00 €**

13 polos con centralita. Con desconexión de antiniebla.
Ref. **766113** · PVR: **120,00 €**



7 polos con centralita. Con desconexión de antiniebla y PDC.
Ref. **766108** · PVR: **115,00 €**

13 polos con centralita. Con desconexión de antiniebla y PDC.
Ref. **766114** · PVR: **135,00 €**

 7 polos con centralita. Con desconexión de antiniebla. Reprogramable NFC.
Ref. **766109** · PVR: **102,00 €**

 13 polos con centralita. Con desconexión de antiniebla. Reprogramable NFC.
Ref. **766119** · PVR: **120,00 €**

 7 polos con centralita. Con desconexión de antiniebla y PDC. Reprogramable NFC.
Ref. **766101** · PVR: **115,00 €**

 13 polos con centralita. Con desconexión de antiniebla y PDC. Reprogramable NFC.
Ref. **766111** · PVR: **135,00 €**

ACCESORIOS KITS ELÉCTRICOS



Kit de extensión de corriente continua pin 9

Ref. **764129** · PVR: **33,00 €**
Ref. **764149** · PVR: **33,00 €**

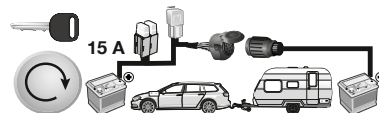

Kit de extensión de corriente bajo contacto pin 10

Ref. **764139** · PVR: **65,00 €**
Ref. **764159** · PVR: **65,00 €**



Portafusible con cable.
Fusible estándar

Ref. **401100** · PVR: **3,90 €**



Portafusible con cable.
Fusible mini

Ref. **401200** · PVR: **3,90 €**

ENCHUFES Y CONECTORES



Base de enchufe hembra 7 polos 12V PVC
Ref. **761759** · PVR: **3,60 €**



Base de enchufe hembra 7 polos 12V PVC
con desconexión antiniebla
Ref. **401007** · PVR: **6,70 €**



Base de enchufe hembra 7 polos 12V
Aluminio
Ref. **401006** · PVR: **6,70 €**



Base de enchufe hembra 13 polos 12 V
PVC sin desconexión antiniebla y goma de
protección.
Ref. **401008** · PVR: **20,10 €**



Clavija de enchufe macho 7 polos 12V
Aluminio. Para remolque, caravana, portabi-
cicletas...
Ref. **401001** · PVR: **5,10 €**



Clavija de enchufe macho 7 polos 12V PVC.
Para remolque, caravana, portabicicletas...
Ref. **767039** · PVR: **3,60 €**



Clavija de enchufe macho 13 polos 12V
PVC. Para remolque, caravana, portabi-
cicletas...
Ref. **767049** · PVR: **18,60 €**



Goma protección base eléctrica con salida
trasera (7 y 13 polos)
Ref. **401002** · PVR: **0,90 €**



Goma de protección base eléctrica con
salida lateral (7 y 13 polos)
Ref. **401003** · PVR: **2,80 €**



Adaptador 13/7 polos Mini
(coche 13 - remolque 7)
Ref. **768009** · PVR: **13,00 €**



Adaptador 7/13 polos Mini
(coche 7 - remolque 13)
Ref. **768019** · PVR: **13,00 €**

TAPAS



Tapa paragolpes (259x94 mm)
Ref. **9600819** · PVR: **65,00 €**

Tapa paragolpes (239x99 mm)
Ref. **9600828** · PVR: **65,00 €**



Maletín para comprobar el funcionamiento
de la instalación eléctrica para remolque
realizada en el vehículo

Ref. **401004** · PVR: **193,00 €**

BOLAS DE ENGANCHE Y ACCESORIOS



Bola Placa MMR 3.500 Kg
2 agujeros Ø 16 mm.
Distancia entre centros 90 mm.

Placa Universal (Tornillos no incluidos)
Ref. **403006** · PVR: **22,00 €**

Brink Placa (Tornillos incluidos)
Ref. **9078032** · PVR: **59,00 €**



Bola 4 agujeros MMR 3.500 Kg
4 agujeros Ø 11 mm.
Distancia anchura 83 mm. Distancia altura 56 mm.

Tornillos no incluidos
Ref. **9077410** · PVR: **94,00 €**



Bola 4 agujeros MMR 3.500 Kg
4 agujeros Ø 11 mm.
Distancia anchura 83 mm.
Distancia altura 56 mm.

Tornillos no incluidos
Ref. **9078500** · PVR: **149,00 €**



Bola-Bulón MMR 3.500 Kg
Ø 16 mm - Distancia entre agujeros 90 mm.

Tornillos no incluidos
Ref. **403001** · PVR: **120,00 €**



Bola cuello de cisne Brink.
Varias medidas.

Ref. · PVR: **115,00 €**



Bola desmontable Brink BMC
Varias medidas.

Ref. · PVR: **395,00 €**



Bola desmontable Brink BMA
Varias medidas.

Ref. · PVR: **395,00 €**



Bola desmontable Brink BMU
Varias medidas.

Ref. · PVR: **395,00 €**



Bola de Rosca.
Incluye tuerca M20

Ref. **403002** · PVR: **21,00 €**

Bola de Rosca especial quads. Incluye tuerca.

Ref. **403004** · PVR: **21,00 €**



Tapabolas Brink.

Ref. **8077800** · PVR: **2,00 €**



Llave recambio BMA/BMU

Ref. **9099962** · PVR: **15,00 €**



Antirrobo BMC.

Ref. **9077760** · PVR: **20,00 €**



Base de enchufe universal fija con tornillos Derecha.

Ref. **9520064** · PVR: **6,20 €**



Base de enchufe universal fija.

Ref. **9520092** · PVR: **12,40 €**



Base de enchufe retráctil izquierda.
Ref. **9520079** · PVR: **16,50 €**

Base de enchufe retráctil derecha.
Ref. **9520095** · PVR: **16,50 €**



Bolsa de tela negra para guardar la bola de enganche.

Ref. **9078003** · PVR: **12,40 €**



Tapa protección caja desmontable.
Tipo BMC
Modelo antiguo

Ref. **9077046** · PVR: **9,30 €**



Tapa de protección caja desmontable tipo BMA/BMC
Modelo moderno

Ref. **9077067** · PVR: **9,30 €**



Tapa de protección caja desmontable tipo BMU

Ref. **9076999** · PVR: **21,00 €**

PILOTOS Y PLACAS



Piloto 4 funciones (104x97 mm).
Incluye bombillas.

Ref. **402001** · PVR: **5,70 €**



Piloto antiniebla sin soporte
(87x77x52 mm)

Ref. **402030** · PVR: **5,10 €**



Piloto 5 funciones RADEX 5001D/S
(195x105 mm)
Izquierdo.

Ref. **402002** · PVR: **15,50 €**



Piloto 5 funciones RADEX 5001D/S
(195x105 mm)
Derecho.

Ref. **402003** · PVR: **15,50 €**



Piloto 5 funciones RADEX 5800
(210x140x60 mm)
Triángulo integrado.
Izquierdo.

Ref. **402005** · PVR: **15,50 €**



Piloto 5 funciones RADEX 5800
(210x140x60 mm)
Triángulo integrado.
Derecho.

Ref. **402006** · PVR: **15,50 €**



Piloto AJ-BA RL80
(188x135x51 mm)
Triángulo integrado.
Izquierdo

Ref. **402007** · PVR: **19,10 €**



Piloto AJ-BA RL80
(188x135x51 mm)
Triángulo integrado.
Derecho

Ref. **402008** · PVR: **19,10 €**



Piloto 5 funciones ASPOCK Multipoint II
Triángulo integrado.
Incluye bombillas
Izquierdo.

Ref. **402011** · PVR: **28,90 €**



Piloto 5 funciones ASPOCK Multipoint II
Triángulo integrado.
Incluye bombillas
Derecho.

Ref. **402012** · PVR: **28,90 €**



Piloto 5 funciones izquierdo RADEX
6800 vertical
(220x160x60 mm)
Triángulo incluido
Izquierdo

Ref. **402013** · PVR: **28,90 €**



Piloto 5 funciones derecho RADEX
6800 vertical
(220x160x60 mm)
Triángulo incluido
Derecho

Ref. **402014** · PVR: **28,90 €**



Piloto 5 funciones vertical AJ-BA FP70
Triángulo integrado
Izquierdo-incluye bombillas
Conector trasero no incluido.

Ref. Conector: **402021** · PVR: **1,70 €**

Ref. **402015** · PVR: **21,60 €**



Piloto 5 funciones vertical AJ-BA FP70
Triángulo integrado
Derecho-incluye bombillas
Conector trasero no incluido.

Ref. Conector: **402024** · PVR: **1,70 €**

Ref. **402016** · PVR: **21,60 €**



Piloto de Gálibo / posición
(65x61x50 mm)

Ref. **402033** · PVR: **5,20 €**



Piloto iluminación matrícula
(90x40x45 mm)

Ref. **402032** · PVR: **5,10 €**



Catadióptrico Redondo Ø 60 mm · Con adhesivo
Rojo: 402041 · Blanco: 402044 · Ámbar: 402047

Catadióptrico Rectangular 57x39 mm · Con adhesivo
Rojo: 402042 · Blanco: 402045 · Ámbar: 402048

PVR: **1,30 €**



Triángulo Reflectante

Ref. **402049** · PVR: **1,30 €**



Placa Galvanizada 1000x140 mm
 Pilotos 4 funciones + antiniebla
 Clavija 7 polos + 3 m de manguera

Ref. **402081** · PVR: **77,30 €**



Placa Galvanizada Extensible
 1000x140 mm
 Pilotos 5 funciones AJ-BA RL80
 con triángulo integrado.
 Clavija 7 polos + 3 m de manguera

Ref. **402082** · PVR: **91,80 €**



Placa Galvanizada Extensible
 1400-2000x140 mm
 Pilotos 4 funciones.
 Clavija 7 polos + 7 m de manguera

Ref. **402071** · PVR: **81,40 €**



Placa Galvanizada Extensible
 1350-2000x140 mm
 Pilotos AJ-BA RL80
 con triángulo integrado.
 Clavija 7 polos + 7 m de manguera

Ref. **402072** · PVR: **112,40 €**



Placa Galvanizada Extensible
 1350-2000x140 mm
 Pilotos AJ-BA RL80
 con triángulo integrado + Luz marcha atrás
 Clavija 13 polos + 7 m de manguera

Ref. **402073** · PVR: **122,70 €**



Placa PVC Remolque Ligero 1300x140 mm
 Piloto 4 funciones con antiniebla.
 Clavija de 7 polos + 6 m de manguera

Ref. **402070** · PVR: **72,20 €**



Manguera para remolque de 7 hilos
 (6x0,75 + 1x1,5 mm).

Dcho.: **402060** PVR: **3,10€/m.**

Manguera para remolque de 7 hilos
 (7x0,75 mm).

Dcho.: **402062** PVR: **3,10€/m.**



Manguera para remolque de 13 hilos
 (8x0,75 + 2x2,5 + 3x1,5 mm)

Dcho.: **402061** PVR: **7,10€/m.**

CABEZALES DE ENGANCHE



Cabezal Al-Ko AK7 eso
MMR 750 Kg.
Sin dispositivo óptico.

Ref. **404001** · PVR: **17,90 €**



Cabezal Al-Ko AK7 C60
MMR 750 Kg.
Sin dispositivo óptico.

Ref. **404002** · PVR: **19,60 €**



Cabezal SPP en V
MMR 750 kg

Ref. **404096** · PVR: **24,20 €**



Cabezal SPP con soporte en V
MMR 750 kg

Ref. **404097** · PVR: **41,10 €**



Cabezal SPP D35 mm
MMR 1700 kg

Ref. **404115** · PVR: **41,10 €**



Cabezal SPP D50 mm
MMR 2200 kg

Ref. **404116** · PVR: **39,00 €**

Con kit de montaje otras medidas
(35, 40, 45 mm)

Ref. **404117** · PVR: **71,00 €**



Cabezal AlKo AK161 D50 mm
MMR 1600 kg

Ref. **404118** · PVR: **79,00 €**

Con kit de montaje otras medidas
(35, 40, 45 mm)

Ref. **404111** · PVR: **85,00 €**



Cabezal Alko AK270 D50 mm
MMR 2700 kg

Ref. **404120** · PVR: **91,00 €**

Con kit de montaje otras medidas
(35, 40, 45 mm)

Ref. **404121** · PVR: **125,00 €**



Kit Cerradura con Safety Ball
Para cabezal AK161 / AK270

Ref. **404122** · PVR: **36,10 €**



Cabezal SPP D50 mm
MMR 3000 kg

Con kit de montaje otras medidas
(35, 40, 45 mm)

Ref. **404092** · PVR: **99,00 €**



Cabezal Estabilizador MR
MMR 750 kg

Ref. **404010** · PVR: **304,20 €**



Cabezal AlKo AK351 Fundición D60 mm
MMR 3500 kg

Ref. **404007** · PVR: **128,90 €**



Cabezal Estabilizador AKS 3004
MMR 3000 kg D50

Con kit de montaje (35,40, 45 mm)

Ref. **404011** · PVR: **555,00 €**



Cabezal Estabilizador AKS 3504.
MMR 3500 kg D60

Con cerradura antirrobo y Safety Ball

Ref. **404026** · PVR: **695,00 €**

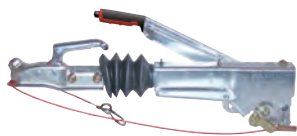

Enganche de inercia en V 1000 kg
cabezal en chapa

Ref. **404005** · PVR: **340,00 €**

Enganche de inercia en V 1600 kg
cabezal en fundición

Ref. **404008** · PVR: **445,00 €**

Enganche de inercia en V 2700 kg
cabezal en fundición

Ref. **404009** · PVR: **530,00 €**



Enganche de inercia en V
MMR 750 kg

Incluye abrazadera para rueda jockey

Ref. **404098** · PVR: **71,20 €**

RUEDAS Y SOPORTES



Rueda Jockey Ø 48 mm.
Goma-acero (200x50 mm)

Ref. **404020** · PVR: **24,70 €**



Rueda Jockey Ø 60 mm.
Goma-acero (200x70 mm)

Ref. **404021** · PVR: **82,10 €**



Rueda Jockey Ø 60 mm.
Automática Goma-acero (200x60 mm)
Incluye abrazadera

Ref. **404022** · PVR: **94,70 €**



Tentemozo Ø 48 mm.

Ref. **404025** · PVR: **20,00 €**



Abrazadera Ø 48 mm.

Ref. **404023** · PVR: **6,90 €**



Abrazadera Ø 60 mm.

Ref. **404024** · PVR: **30,50 €**



Rueda completa 4.00.8"

Ref. **404030** · PVR: **52,10 €**



Rueda completa 4.50.10"

Ref. **404031** · PVR: **77,90 €**



Rueda completa 5.00.10"

Ref. **404032** · PVR: **77,90 €**



Rueda completa 135/80R13

Ref. **404033** · PVR: **89,50 €**



Rueda completa 145/80R13

Ref. **404034** · PVR: **103,20 €**



Rueda completa 155/80R13

Ref. **404035** · PVR: **93,70 €**

Consulta precios para otras medidas de ruedas y guardabarros



Guardabarros plástico para rueda 8"
Ref. **404042** · PVR: **12,90 €**

Guardabarros plástico para rueda 10"
Ref. **404040** · PVR: **16,50 €**

Guardabarros plástico
Reforzado para rueda 135/145/155 x13"
Ref. **404041** · PVR: **22,20 €**

Guardabarros plástico
Reforzado para rueda 165/175 x13"
Ref. **404043** · PVR: **24,30 €**

Guardabarros plástico
Reforzado para Tándem/Doble eje
Ref. **404044** · PVR: **67,10 €**

VARIOS



Cerradura antirrobo.
AK7

Ref. 404052 · PVR: 5,20 €



Cable de seguridad enganche de inercia

Ref. 404056 · PVR: 5,10 €



Antirrobo Universal SPP Z3.

Ref. 404069 · PVR: 30,50 €



Antirrobo universal AI-Ko.

Ref. 404054 · PVR: 33,00 €

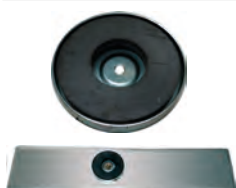

Plot Magnético (ímán).
Placa de matrícula no incluida.

Ref. 404059 · PVR: 8,10 €



Soporte para matrículas rectangulares.
2 unidades.
Acero inoxidable.

Ref. 404090 · PVR: 9,00 €



Portaenchufe AI-Ko.

Ref. 404104 · PVR: 5,70 €



Protector cabezal de enganche.

Ref. 404067 · PVR: 6,30 €



Guardapolvos cabezal de inercia R35 mm.

Ref. 404058 · PVR: 15,00 €



Calce de plástico. Hasta 3 Tn.
(220x100x140 mm)

Ref. 404085 · PVR: 9,00 €

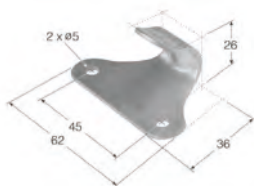

Gancho Chapa corazón para toldo.

Ref. 404066 · PVR: 0,90 €



Anilla abatible sujeta cinchas

Ref. 404081 · PVR: 6,90 €

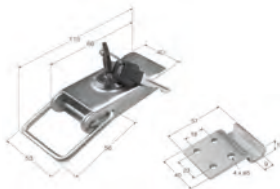

Cierre para remolque con llave
Ref. 404113 · PVR: 11,60 €

Uña para cierre

Ref. 404114 · PVR: 1,60 €

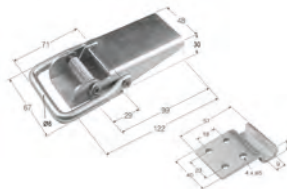

Cierre para remolque
Ref. 404112 · PVR: 7,40 €

Uña para cierre

Ref. 404114 · PVR: 1,60 €



Balancín para guía motos

Ref. 404180 · PVR: 55,00 €



Cepo para rueda motos

Ref. 404181 · PVR: 125,30 €



Placa V20.
Señalización de mercancía saliente
Ref. 404050 · PVR: 34,50 €



Placa V20 ABS
Flexible, con protección trasera antiarañazos
Ref. 404049 · PVR: 40,70 €



Soporte para guardar el portabicicletas en pared.
No válido para los modelos:
Thule EasyFold / VeloSpace
Ref. 404103 · PVR: 31,00 €



Soporte para guardar el portabicicletas en pared.
Válido para todos los modelos.
Ref. 404107 · PVR: 48,50 €



Tensor elástico fijación placa V20 (4 ud.)
Ref. 404130 · PVR: 10,90 €

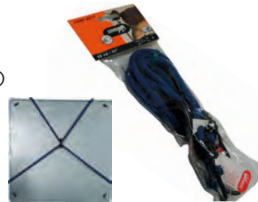

Pulpo Araña 60 cm (2 unidades)
Especial para placa V20 (1 Unidad)
Placa no incluida
Ref. 404110 · PVR: 7,10 €



Pulpo goma redondo 80 cm (2 unidades)
Ref. 404100 · PVR: 4,70 €



Correa sujeta ruedas para portabicicletas (2 unidades)
Ref. 404109 · PVR: 5,10 €



Eslinga 25 mm x 5 mts.
Carga máx. 400 kg.
Ref. 404051 · PVR: 6,70 €



Placa PVC portamatrícula con pilotos.
Enchufe de 7 polos
Ref. 402078 · PVR: 62,00 €



Cabestrante DWK12
Longitud cinta: 10 m
Carga máxima 540 Kg
Peso: 3,2 kg
Ref. 404140 · PVR: 47,40€



Cabestrante DWK16
Longitud cinta: 10 m.
Carga Máxima 725 kg.
Peso: 3,4 kg.
Ref. 404141 · PVR: 57,90€



Cabestrante DWK25
Longitud cinta: 10 m
Carga máxima 1100 Kg
Peso: 5 kg
Ref. 404142 · PVR: 65,30 €



Cabestrante DWK25V
2 velocidades
Longitud cinta: 10 m
Carga Máxima: 1133 kg
Peso: 5 kg.
Ref. 404143 · PVR: 75,80€



Cabestrante DWK26V
Autofrenado
Longitud cable acero: 10 m
Carga máxima 1200 Kg
Peso: 12 kg
Ref. 404150 · PVR: 226,30 €



Cabestrante DWK35V
2 velocidades
Longitud cinta: 10 m
Carga Máxima: 1588 kg
Peso: 5,7 kg.
Ref. 404144 · PVR: 104,20€



Cabrestante DWM 2500 ST
Voltaje: 12 V. Motor: 0,9 hp Autofrenado
Longitud cable: 10 m.
Carga máxima 1.133 Kg
Peso: 6 kg
Mando a distancia y control remoto
Ref. 404160 · PVR: 247,40 €



Cabrestante DWM 3500 ST
Voltaje: 12 V. Motor: 0,9 hp Autofrenado
Longitud cable: 10 m.
Carga máxima 1.588 Kg
Peso: 11 kg
Mando a distancia y control remoto
Ref. 404161 · PVR: 289,50 €

Ejes de velocidad para remolques ligeros desde 300 kg de MMA

Eje sin Freno

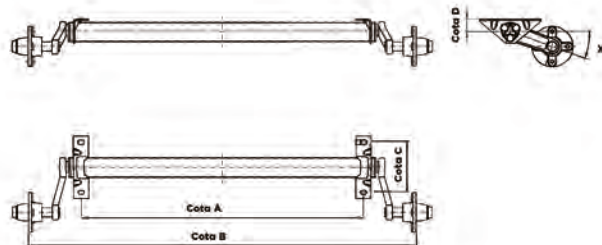

Eje con Freno de tambor

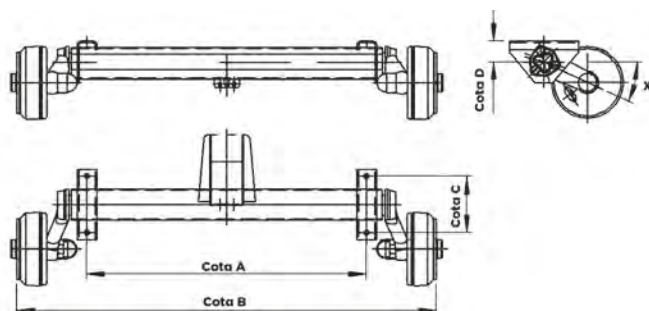

Para solicitar presupuesto de un eje, por favor, tome nota de los siguientes datos y envíelos a info@thu2. es:

Eje SIN FRENO

Eje CON FRENO

Capacidad de carga: Kg.

Medida cota A: mm.

Medida cota B: mm.

Medida cota C: mm.

Medida cota D: mm. o Grados X°:



help flash

Señalización inmediata del vehículo ante cualquier avería o accidente

- Activación magnética automática
- Autónomo y sin cables, funciona con una pila de 9v.
- Visible a 1 km y en 360°
- Función linterna con luz blanca
- IP54. Compatible con todo tipo de condiciones meteorológicas

Recomendado para vehículos turismos, 4x4, SUV, camiones, furgonetas y especialmente recomendado para ancianos, embarazadas, personas con movilidad reducida y vehículos de dos ruedas.

Ref. 404201 · PVR: 25,00 €



El elemento perfecto para hacerte ver en carretera. No más sustos. Help Flash se ve a 1 km. de distancia. Incorpora función aviso de avería, luz ámbar intermitente y luz blanca fija, para que también lo puedas utilizar como linterna.

Especialmente recomendado por la DGT como elemento señalizador, apartado 4 del reglamento de Seguridad Vial "Dispositivos de señalización", clasificado como señal V-16.



Protectores Bicicleta

Set de 6 protectores para bicicleta (cuadro x1, pedal x1, horquilla delantera x1, cassette de piñones x1, llantas x2).

Ref. 405041 · PVR: 36,00 €



Sensores inalámbricos

Olvídate de los cables. Aptos para instalar en el portabicicletas o en el propio vehículo. Sin cables.

Ref. 405042 · PVR: 89,00 €



Soporte portabicicletas Lanza

Se instala sobre la lanza de la caravana para colocar el portabicicletas de bola sobre él.

Ref. 405090 · PVR: 79,00 €

THULE



Tercera Luz de Freno Thule 9904

Accesorio para colocar en el vehículo cuando la carga o el portabicicletas tapan la tercera luz de freno.

Ref. 990400 · PVR: 137,11 €



Thule Light Board 976

Sustituye a las principales luces traseras del vehículo (conector de 7 polos).

Ref. 976000 · PVR: 71,82 €



Cerradura Thule 567

Para bloquear el portabicicletas Thule BackPac 973 al vehículo.

Ref. 567000 · PVR: 22,23 €



Cerradura Thule 957

Para bloquear los portabicicletas Thule HangOn 972/974/9708, Thule HangOn 9502/9503 Thule EasyBase 949

Ref. 957000 · PVR: 13,97 €



Thule AcuTight Knob

Pomo con limitador de apriete (una unidad)

Ref. 528001 · PVR: 21,40 €



Thule Lokable Knob Juego 2 pomos

Ref. 526010 · PVR: 28,84 €

Juego 4 pomos

Ref. 527010 · PVR: 51,16 €



Thule Straps Correas de seguridad de carga

Juego de 2 x 275 cm
Ref. 524000 · PVR: 18,10 €

Juego de 2 x 400 cm
Ref. 523000 · PVR: 21,40 €

Juego de 2 x 600 cm
Ref. 551000 · PVR: 24,71 €



Thule Wheel Strap Locks

Cerraduras para correas.

Ref. 986000 · PVR: 9,83 €



Thule XXL Fatbike Wheel Straps

Correas extralargas compatibles con Thule EasyFold XT y Thule VeloSpace XT.

Ref. 985000 · PVR: 11,49 €



Protector Thule 984

Perfecto para proteger los cuadros de carbono.

Ref. 984000 · PVR: 20,85 €



Cable de seguridad Thule 538

Cable de acero recubierto de plástico que fija la bicicleta al portabicicletas (180 cm).

Ref. 538000 · PVR: 37,93 €



Thule WheelAdapter 9772

Protege las llantas de la bicicleta de montaña y fija las ruedas de las bicicletas de carretera (2 unidades).

Ref. 977200 · PVR: 12,31 €



Percha de Pared Thule 9771

Para el almacenamiento funcional de bicicletas y portabicicletas.

Ref. 977101 · PVR: 47,85 €



Adaptador Thule 982

Para un ajuste fácil en bicicletas de cuadro no estándar (Bicicletas de señora, BMX y descenso).

Ref. 982003 · PVR: 26,36 €



Thule Wheel Carrier 545-2

Portarruedas para la rueda delantera con eje normal o ruedas con freno de disco.

Ref. 545200 · PVR: 62,73 €



Thule Wheel Bag 563 XL

Bolsa de alta calidad especialmente diseñada para la rueda delantera.

Ref. 563000 · PVR: 35,45 €



Thule Standard Key
Según numeración · PVR: 6,50 €



Thule Comfort Key
Según numeración · PVR: 10,50 €



Thule Premium Key
Según numeración · PVR: 10,50 €



Thule MultiLift 572
La forma perfecta de guardar un cofre portaequipajes de techo. Perfecto también para Kayaks y tablas de Surf
Ref. 572000 · PVR: 118,93 €



Thule Box Ski Carrier Adapter 694
Para el transporte seguro y protegido de los esquís dentro del cofre. Consulte según modelo de cofre.
desde
Ref. 694*** · PVR: 37,11 €



Thule Box Lid Cover 6981
Funda que protege el cofre de arañazos y polvo cuando se guarda. Tamaño según modelo de cofre.
698100 Cofre S/M/L · PVR: 39,59 €
698200 Cofre Sport/Alpine · PVR: 39,59 €
698400 Cofre XXL · PVR: 39,59 €

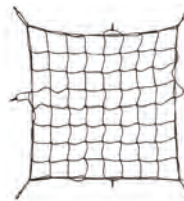

Red de Carga Thule
Para la baca Thule Trail 823
Ref. 823900 · PVR: 76,78 €
Para la baca Thule Trail 824
Ref. 824900 · PVR: 86,69 €



Thule GoPack 8002
Diseño especial para optimizar la utilización del espacio en el cofre.
Tamaño: 73x38x31 cm.
Ref. 800202 · PVR: 47,85 €



Thule GoPack Set 8006
Conjunto de cuatro bolsos para aprovechar al máximo el espacio de su cofre. Incluye 3 GoPack 8002 y un GoPack Nose 8001.
Ref. 800603 · PVR: 180,91 €



Sistema One Key de Thule
Reemplace todas las cerraduras en sus productos Thule y utilice la misma llave para todos.
4 cerraduras de seguridad
Ref. 504400 · PVR: 28,88 €
6 cerraduras de seguridad
Ref. 506000 · PVR: 34,67 €
8 cerraduras de seguridad
Ref. 508000 · PVR: 39,63 €
12 cerraduras de seguridad
Ref. 512000 · PVR: 59,46 €
16 cerraduras de seguridad
Ref. 516000 · PVR: 59,46 €



Adaptador T para cofre
Ajuste el cofre portaequipajes directamente en la guía T de la barra de techo. (FastGrip/PowerGrip).
Adaptador T para cofres 24x30 mm
Ref. 696001 · PVR: 23,88 €
Adaptador T para Power-Click 24x30
Ref. 696500 · PVR: 34,63 €
Adaptador T 20x27 mm
Ref. 697104 · PVR: 23,88 €
Adaptador T 20x27 mm (FastGrip/PowerGrip)
Ref. 697400 · PVR: 33,63 €
Adaptador T 20 mm Power-Click 62x63
Ref. 697600 · PVR: 34,63 €



Thule WaterSlide 839
Alfombrilla técnica que protege el vehículo durante la carga y descarga del kayak o canoa.
Ref. 839000 · PVR: 29,67 €



Poleas con gancho Thule 838
Perfecto para usar de proa a popa.
Ref. 838000 · PVR: 43,72 €



Thule WindSurfing 5603
Sujeción acolchada para transporte de embarcaciones (2 unidades).
Ref. 560300 · PVR: 13,97 €



Thule Box Light
Luz interior para el interior de los cofres Thule con encendido y apagado automático.
Ref.: 695100 · PVR: 44,55 €

THULE

**Cofres portatubos Thule 3171**

Mantiene y protege los tubos de la forma más segura posible.

Aluminio

Ref. **317100** · PVR: **466,86 €**

**Separador Interior Thule Box 3181**

Accesorio para cofre portatubos Thule 317 que facilita la separación de tubos largos y coros y el acceso a los mismos.

Ref. **318100** · PVR: **51,20 €**

**Rulo Thule 334 (65 cm)**

Facilita la carga de escaleras, tablonos y otros objetos largos desde la parte de atrás del vehículo.

Ref. **334100** · PVR: **89,17 €**

**Rulo Thule 335 (110 cm)**

Facilita la carga de escaleras, tablonos y otros objetos largos desde la parte de atrás del vehículo.

Ref. **335100** · PVR: **106,53 €**

**Rulo Thule 336 (30 cm).
Sólo para 322**

Facilita la carga de escaleras, tablonos y otros objetos largos desde la parte de atrás del vehículo. (Bajo pedido).

Ref. **336000** · PVR: **67,69 €**

**Rulo Extensible Thule 340**

Extiende el portaequipajes en la parte trasera para facilitar la carga desde la parte posterior del vehículo. (Bajo pedido).

Ref. **340000** · PVR: **247,85 €**

**Tope Thule 314**

Tope robusto y funcional que mantiene la carga sujeta e impide su deslizamiento.

Ref. **314000** · PVR: **25,54 €**

**Tope Plegable Thule 315**

Tope robusto y funcional que mantiene la carga sujeta e impide su deslizamiento.

Ref. **315000** · PVR: **62,73 €**

**Tope Frontal Thule 321**

Para el transporte seguro en el techo. Se instala en el perfil lateral Thule 322.

Ref. **321000** · PVR: **91,65 €**

**Perfil Lateral Thule 322**

Perfiles laterales modulares, para personalizar la longitud del portaequipajes y ajustarse, así, a cada vehículo. Para instalar el Tope Thule 321

Ref. **322000** · PVR: **213,97 €**

**Toldo Thule 326/327/328**

El complemento perfecto para tu vehículo si tienes que trabajar a la intemperie. Se instala sobre las barras de techo.

3,5 m Ref. **328000** · PVR: **1.313,22 €**

**Correa Ajustable con carraca Thule 552**

Correa y tope de carga, todo en uno.

Ref. **552000** · PVR: **81,74 €**

**Portaescaleras Thule 548**

Para cargar y sujetar la escalera al portaequipajes de forma fácil y segura.

Ref. **548000** · PVR: **68,51 €**

**Portaescaleras Extensible Thule 311**

Se puede extraer del techo e inclinar sobre el lateral del vehículo ofreciendo una zona confortable de altura de carga.

Ref. **311010** · PVR: **550,33 €**

**Portaescaleras Thule 330**

Portaescaleras de fácil manejo con una fijación exclusiva.

Sólo en ProBar.

Ref. **330000** · PVR: **120,58 €**

**Adaptador Escalera Thule 310**

Se utiliza cuando los escalones no encajan en la posición del portaescaleras.

Ref. **310000** · PVR: **22,23 €**

**Correa Thule 323**

Garantiza una sujeción rápida y segura de la carga. Con trinquete y ganchos.

Ref. **323000** · PVR: **18,93 €**

**Correa con bloqueo Thule 841**

Innovadora, con llave antirrobo para proteger lo que transportas (2x400 cm)

Ref. **841000** · PVR: **69,34 €**



Topes de carga Cruz 941

Mantiene y protege los tubos de la forma más segura posible. Aluminio. Varias medidas.

desde
Ref. 941** · PVR: 19,84 €



Fijación de tubos Cruz 94103

Facilita el transporte de tubos. Diámetros: 9 · 11 · 12,5 · 16 · 20 cm

desde
Ref. 94103* · PVR: 26,45 €



Fijación escalera

Cruz M-12/37 cm
Ref. 941041 · PVR: 26,45 €

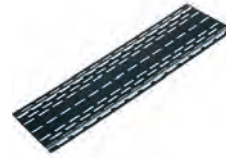

Pasarela Cruz

Permite pisar de forma segura en la baca. Varias medidas. Son necesarios juegos de fijaciones 941-271/272/276/277. Consultar.

desde
Ref. 94126* · PVR: 20,66 €



Fijación escalera

Cruz M-12/44 cm
Ref. 941042 · PVR: 27,27 €



Escalera Plegable Cruz

Facilita el acceso al techo del vehículo y es fácil de guardar.

desde
Techo bajo. Ref. 941051 · PVR: 110,74 €
Techo alto. Ref. 941052 · PVR: 121,49 €
Techo sobreelevado.
Ref. 941053 · PVR: 127,27 €



Escalera Fija Cruz tipo B

Fijación al marco de la puerta, compatible con puerta acristalada. Kit de fijación no incluido.

Ref. 941072 B-155 · PVR: 158,68 €
Ref. 941074 B-185 · PVR: 161,98 €
Ref. 941076 B-208 · PVR: 168,60 €



Soportes de Rulo

Necesarios para instalar el rulo en las barras de techo. Consulte el modelo adecuado para su barra.

desde
Barras 30x20. Ref. 941100 · PVR: 15,70 €
Barras 35x35. Ref. 941101 · PVR: 15,70 €



Escalera Fija Cruz tipo EF

Fijación con tornillos, sólo puertas sin cristal.

Ref. 941060 EF-120 · PVR: 81,82 €
Ref. 941062 EF-150 · PVR: 88,43 €
Ref. 941064 EF-180 · PVR: 98,35 €



Rulo Cruz

Permite la carga y descarga de mercancías largas, como escaleras o tableros de forma cómoda. De 60 hasta 178 cm.

desde
Ref. 9411** · PVR: 15,70 €



Extensión para Rulo

Para una mayor facilidad de carga de la escalera o de otros objetos largos.

Barra perfil 30x20
Ref. 941186 · PVR: 64,46 €
Barra perfil 52x35
Ref. 941188 · PVR: 47,93 €



Cáncamos Cruz M8

Permite asegurar la carga que transportamos en las barras (2 unidades). Válido para barras con ranura

Ref. 941310 · PVR: 5,79 €



Soporte de Rulo Alu Cargo 52x35

Ref. 941104 · PVR: 17,36 €

Soporte de Rulo Evo Rack 44x39

Ref. 941109 · PVR: 18,18 €

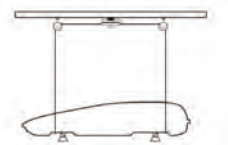

Cruz Lift

Para guardar tu cofre, kayak o canoa

Ref. 940403 · PVR: 49,55 €



Deflector de Barras para Cruz Cargo XPro

Mejora la aerodinámica de las barras desviando el aire. Varias medidas.

desde
Ref. 94122* · PVR: 34,71 €



Correas Cruz

2 x 3 metros
Ref. 941300 · PVR: 9,09 €



Correas con protector Cruz

2 x 3 metros
Ref. 941303 · PVR: 9,92 €



Correas con Trinquete Cruz

1x5 metros
Ref. 941301 · PVR: 9,09 €

Correas con Trinquete Cruz

2x5 metros
Ref. 941302 · PVR: 14,88 €



Correa con Trinquete y Gancho Cruz

Perfecta para sujetar de forma segura la carga. 1 x 5 metros.

Ref. 941304 · PVR: 14,88 €

TARIFA 2020	SEUR/CORREOS		CORREOS EXPRESS	
	ESPAÑA/PORTUGAL	Baleares	Las Palmas y Tenerife	Resto Islas
	Peninsular		Aéreo	Aéreo
	€/unidad	€/unidad	€/unidad	€/unidad
1 enganche	9,50	15,50	77,00	99,00
2 enganches	8,50	12,50	77,00	99,00
3 enganches	7,50	11,50	77,00	99,00
4 enganches	sin cargo	sin cargo	77,00	99,00
Hasta 5 kilos	6,50	11,50	42,00	49,00
Barra de techo	9,50	15,50	77,00	99,00
Portabicicletas	12,00	20,00	99,00	120,00
Cofres / Evorack Pro	20,00	70,00	Consultar	Consultar
Devoluciones enganches	15,00	20,00	A cargo cliente	A cargo cliente

Portes sin cargo en pedidos superiores a 400,00 € (exclusivamente en España Peninsular)

Plazos de entrega

Plazos de entrega en España Peninsular: 24 horas

Plazos de entrega en Baleares: 48/72 horas

Plazos de entrega aproximados en marítimo: 10 días desde la fecha de embarque

Plazos de entrega aproximados en aéreo: 3 a 4 días

Otros gastos

Comisión de reembolso: 3% del importe de la factura (mínimo 3,00 €)

Canarias: Despacho de aduanas de exportación e importación a cargo del cliente

IVA no incluido

Thu2 Spain declina cualquier tipo de responsabilidad por incumplimiento de los plazos de entrega de la agencia de transporte.

Thu2 Spain no se hará responsable de los desperfectos, roturas o cualquier otra incidencia relacionada con la mercancía, que no haya sido comunicada en las 24 horas posteriores a la entrega del producto.

CONDICIONES GENERALES

La presente tarifa entra en vigor el 1 de febrero de 2021 y estará vigente hasta el 31 de enero de 2022. Thu2 Spain, S.L. (en adelante Thu2) se reserva el derecho de modificación de los precios indicados sin previo aviso. Los datos y precios que aparecen en el presente documento son válidos salvo error tipográfico o de imprenta. IVA no incluido.

Todos los enganches Brink que constan en este catálogo disponen de las homologaciones correspondientes a nivel europeo y son adaptables a las marcas citadas.

El material objeto de la compra-venta será propiedad de Thu2 hasta el pago total de la factura por parte del comprador.

Todos los productos Brink tienen una garantía de 2 años a partir de la fecha de entrega, conforme a lo dispuesto en la Directiva 1999/CE y la Ley 23/2003. Esta garantía queda limitada únicamente a reemplazar el producto defectuoso. No entran en garantía los productos o piezas por desgaste, ni los daños derivados de un uso inadecuado del producto y/o incumplimiento de las normas de circulación. Queda prohibida cualquier modificación o cambio sobre el producto. En caso de modificación, quedará nula la garantía y la responsabilidad en todos los casos.

El fabricante de los productos no se responsabilizará de los defectos o vicios manifiestos de calidad o fabricación que no sean comunicados en un plazo máximo de una semana desde la fecha de entrega el producto.

Thu2 no será responsable de la verificación de los datos aportados por el cliente, ni tampoco de los datos introducidos al solicitar el informe de conformidad. Por favor, compruebe que su vehículo está capacitado para instalar un enganche de remolque.

Todos los gastos derivados del envío de mercancía serán por cuenta del comprador. No obstante, Thu2 pone a disposición del cliente varias opciones de transporte a las que podrá acogerse el comprador, en este caso cualquier incidencia y/o desperfecto que pudiera producirse en el

material suministrado durante el transporte deberá ser comunicado a Thu2 en un plazo no superior a 24h. desde la recepción del mismo.

No se aceptarán devoluciones de mercancía transcurridos 15 días desde la entrega de la misma, ni de aquellas que no hayan sido previamente comunicadas a Thu2, así como de aquellas que no conserven el embalaje original. La mercancía se devolverá acompañada del albarán de entrega y del documento de devolución autorizado, indicando el motivo de la devolución a portes pagados por el comprador, o bien se puede solicitar la gestión de recogida a nuestras oficinas, repercutiendo posteriormente el importe de los gastos de transporte en la factura de abono. Todo material devuelto por causas ajenas a Thu2 se abonará con una penalización del 15% en concepto de gastos de reacondicionamiento.

No se admiten devoluciones de kits eléctricos o electrónicos. Thu2 no se responsabiliza de los daños, borrados de memoria y/o desprogramaciones que se puedan causar en los vehículos motivados por la instalación del kit eléctrico o electrónico.

Para cualquier discrepancia suscitada en relación a la compra-venta y suministro del producto y/o material suministrado se regirá por la Ley Española, quedando las partes expresamente sometidas a la competencia de los Juzgados y Tribunales de Zaragoza (España), renunciando expresamente las partes a cualquier otro fuero que pudiera corresponderles.

Los precios y tarifas incluidos en el presente catálogo no incluyen IVA. Thu2 Spain, S.L. se reserva el derecho de introducir modificaciones en modelo(s) y/o precios en cualquier momento. Aunque este catálogo se ha elaborado con el mayor cuidado, no nos hacemos responsables de posibles equivocaciones, inexactitudes o errores tipográficos de cualquier naturaleza. Ningún fragmento de esta publicación podrá ser reproducido sin el permiso por escrito de Thu2 Spain, S.L.

REF. ESPECIFICACIONES

2.	Para vehículos sin preinstalación eléctrica
3.	Para vehículos con preinstalación eléctrica
4.	Con y sin preinstalación eléctrica
5.	Sólo vehículos Opel Antara con conector de 12 pines
7.	Para vehículos con conectores originales
8.	Sólo para vehículos con conexión de enganche en el módulo SAM
9.	Vehículos OPEL con REC (Rear Electronic Centre)

• Si es preciso realizar una activación externa, el coste final puede aumentar.

Los precios y tarifas incluidos en el presente catálogo NO incluyen IVA. Thu2 Spain, S.L. se reserva el derecho de introducir modificaciones en modelo(s) y/o precios en cualquier momento. Aunque este catálogo se ha elaborado con el mayor cuidado, no nos hacemos responsables de posibles equivocaciones, inexactitudes o errores tipográficos de cualquier naturaleza. Ningún fragmento de esta publicación podrá ser reproducido sin el permiso por escrito de Thu2 Spain, S.L.

Enganche

	Modelo de vehículo		Fijo Cuello de cisne
	Referencia enganche		Bola de placa 2 agujeros
	Fecha de fabricación		Bola de placa 4 agujeros
	Tipo de enganche		Bola mixta
	Recorte del paragolpes		Desmontable
	Valor D		BMC extrahible horizontalmente
	Carga vertical máxima		BMA Diagonal extrahible diagonalmente
	Masa Máxima Remolcable (MMR)		BMU extrahible verticalmente
	Precio		Retráctil
			MX retráctil

Tiempo de montaje

	Tiempo de montaje del enganche
A	0,5 - 1 horas
B	1 - 1,5 horas
C	1,5 - 2 horas
D	> 2 horas
	Tiempo de montaje del kit eléctrico
E	< 0,5 horas
F	0,5 - 1 hora
G	1 - 1,5 horas
H	> 1,5 horas
U	Kit universal

Kit eléctrico

	Referencia kit		Activación
	Conector 7/13		● Automático ○ Activación necesaria
	Centralita necesaria		D Activación en concesionario Z Sistema Flex sin codificación
	Comunicación con red CAN		● Automático ○ Activación necesaria
	Corriente continua 12 V		S Por conectar en el vehículo de aparcamiento D Activación en concesionario
	Corriente continua de contacto		A Sin 12 V. (pin 9), kit de extensión requerido 764129 B 12 V. (pin 9), kit de extensión requerido 764129 C Incluido kit 12 V. (pin 9) K Sin 12 V. (pin 9), kit de extensión requerido 764189 M Sin 12 V. (pin 9), kit de extensión requerido 764149 O Sin 12 V. (pin 9), kit de extensión requerido 764199 R Sin 12 V. (pin 9), kit de extensión requerido 765079 D Sin carga de batería (pin 10), kit de extensión requerido 764139 E Preparado para cargar batería (pin 10), kit de extensión requerido 764139 F Incluye carga de batería (pin 10) L No disponible conexión 12 V de contacto N Preparado para cargar batería (pin 10), kit de extensión requerido 764189 P Preparado para cargar batería (pin 10), kit de extensión requerido 764199 Q Preparado para cargar batería (pin 10), kit de extensión requerido 765079 S Preparado para cargar batería (pin 10), kit de extensión requerido 765089 J Preparado para cargar batería (pin 10), kit de extensión requerido 764169



PORTABICICLETAS



BARRAS DE TECHO



COFRES



PORTAEQUIPAJES



ACCESORIOS REMOLQUE



ACCESORIOS AUTOMÓVIL



THU2
SPAIN

Ctra. de Castellón, km. 3
Pol. San Carlos, nave 2
50013 Zaragoza
Tel. 976 493 113
Móvil 654 291 288
Fax 976 423 532
info@thu2.es
www.thu2.es